

DK27..FQ/W

FAST SWITCHING THYRISTOR

APPLICATIONS

- High Power Inverters And Choppers.
- UPS.
- AC Motor Drives.
- Induction Heating.
- Cycloconverters.

KEY PARAMETERS

V_{DRM}	800V
$I_{T(RMS)}$	290A
I_{TSM}	5000A
dV/dt	200V/ μ s
dI/dt	500A/ μ s
t_q	7-10 μ s

FEATURES

- Low Switching Losses At High Frequency.
- Fully Characterised For Operation Up To 20kHz.

VOLTAGE RATINGS

Type Number	Repetitive Peak Voltages V_{DRM} V_{RRM} V	Conditions
DK27 08FQ K or M DK27 06FQ K or M and	800 600 and	$V_{RSM} = V_{RRM} + 100V$ $I_{DRM} = I_{RRM} = 25mA$
DK27 08FW K or M DK27 06 FW Kor M	800 600	at V_{RRM} or V_{DRM} & T_{vj}

Q = t_q code = 7 μ s. e.g. DK27 08FQK.

W = t_q code = 10 μ s. e.g. DK27 08FWK.

For 3/4" 16 UNF thread add K to type number, e.g. DK27 08FQK.

For M16 thread add M to type number, e.g. DK27 06FWM.

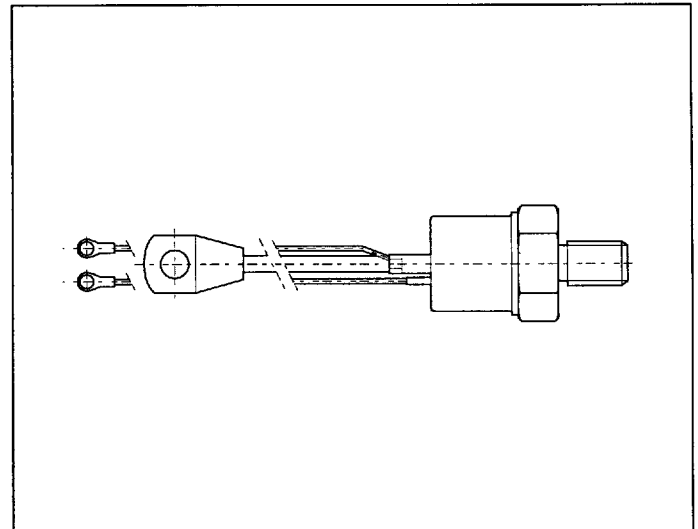

Outline type code: TO93 Turn to page 12 for further information.

CURRENT RATINGS

Symbol	Parameter	Conditions	Max.	Units
$I_{T(AV)}$	Mean on-state current	Half wave resistive load, $T_{case} = 80^\circ C$	185	A
$I_{T(RMS)}$	RMS value	$T_{case} = 80^\circ C$	290	A

SURGE RATINGS

Symbol	Parameter	Conditions	Max.	Units
I_{TSM}	Surge (non-repetitive) on-state current	$t_p \geq 10\text{ms}$ half sine; $T_{\text{case}} = 125^\circ\text{C}$ $V_R = 0\% V_{RRM} - 1/4$ sine	5.0	kA
I^2t	I^2t for fusing		125.0×10^3	A ² s

THERMAL AND MECHANICAL DATA

Symbol	Parameter	Conditions	Min.	Max.	Units
$R_{th(j-c)}$	Thermal resistance - junction to case	dc	-	0.13	°C/W
$R_{th(c-h)}$	Thermal resistance - case to heatsink	Mounting torque 35.0Nm with mounting compound	-	0.06	°C/W
T_{vj}	Virtual junction temperature	On-state (conducting)	-	125	°C
		Reverse (blocking)	-	125	°C
T_{stg}	Storage temperature range		-40	150	°C
-	Mounting torque		30.0	35.0	Nm

DYNAMIC CHARACTERISTICS

Symbol	Parameter	Conditions	Min.	Max.	Units	
V_{TM}	Maximum on-state voltage	At 600A peak, $T_{\text{case}} = 25^\circ\text{C}$	-	1.85	V	
I_{RRM}/I_{DRM}	Peak reverse and off-state current	At V_{RRM}/V_{DRM} , $T_{\text{case}} = 125^\circ\text{C}$	-	25	mA	
dV/dt	Maximum linear rate of rise of off-state voltage	Linear to 60% V_{DRM} , $T_j = 125^\circ\text{C}$, Gate open circuit	-	200	V/ μs	
dI/dt	Rate of rise of on-state current	Gate source 20V, 20 Ω	Repetitive 50Hz	-	500	A/ μs
		$t_r < 0.5\mu\text{s}$, $T_j = 125^\circ\text{C}$	Non-repetitive	-	800	A/ μs
$V_{T(TO)}$	Threshold voltage	At $T_{vj} = 125^\circ\text{C}$	-	1.2	V	
r_T	On-state slope resistance	At $T_{vj} = 125^\circ\text{C}$	-	1.0	m Ω	
t_{gd}	Delay time	$T_j = 25^\circ\text{C}$, $I_T = 50\text{A}$, $V_D = 300\text{V}$, $I_G = 1\text{A}$, $dI/dt = 30\text{A}/\mu\text{s}$, $dI_G/dt = 1\text{A}/\mu\text{s}$	3*	-	μs	
$t_{(ON)TOT}$	Total turn-on time		1.5*	-	μs	
I_H	Holding current	$T_j = 25^\circ\text{C}$, $I_{TM} = 1\text{A}$, $V_D = 12\text{V}$	-	70	mA	
t_q	Turn-off time	$T_j = 125^\circ\text{C}$, $I_T = 200\text{A}$, $V_R = 50\text{V}$, $dV/dt = 200\text{V}/\mu\text{s}$ (Linear to 60% V_{DRM}), $dI_R/dt = 30\text{A}/\mu\text{s}$, Gate open circuit	t_q code: Q	-	7	μs
			t_q code: W	-	10	μs

*Typical value.

GATE TRIGGER CHARACTERISTICS AND RATINGS

Symbol	Parameter	Conditions	Typ.	Max.	Units
V_{GT}	Gate trigger voltage	$V_{DRM} = 12V, T_{case} = 25^{\circ}C, R_L = 6\Omega$	-	3.0	V
I_{GT}	Gate trigger current	$V_{DRM} = 12V, T_{case} = 25^{\circ}C, R_L = 6\Omega$	-	200	mA
V_{GD}	Gate non-trigger voltage	At $V_{DRM}, T_{case} = 125^{\circ}C, R_L = 1k\Omega$	-	0.2	V
V_{RGM}	Peak reverse gate voltage		-	5.0	V
I_{FGM}	Peak forward gate current	Anode positive with respect to cathode	-	4	A
P_{GM}	Peak gate power		-	16	W
$P_{G(AV)}$	Mean gate power		-	3.0	W

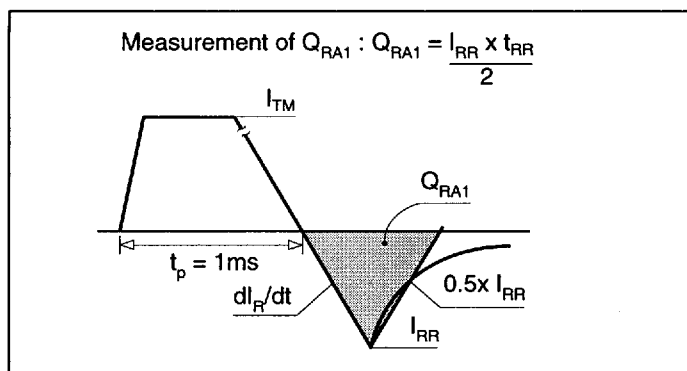
MEASUREMENT OF RECOVERED CHARGE - Q_{RA1} 

CURVES

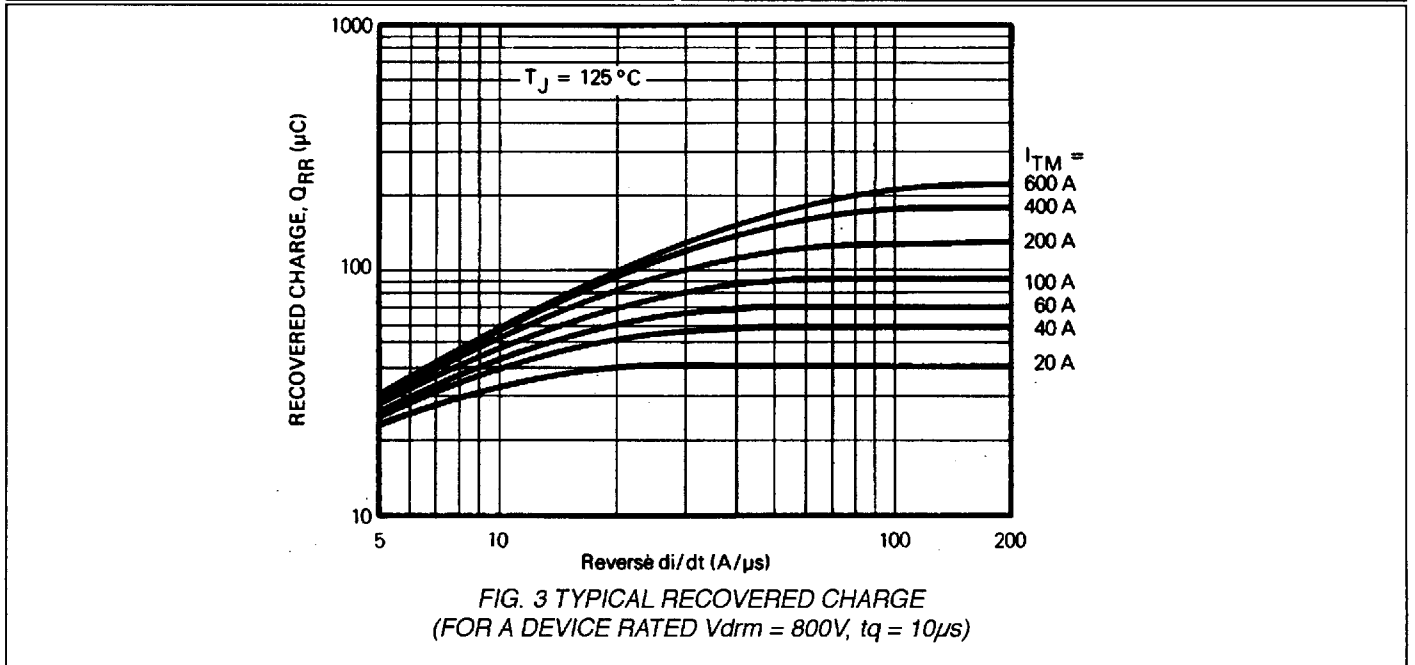
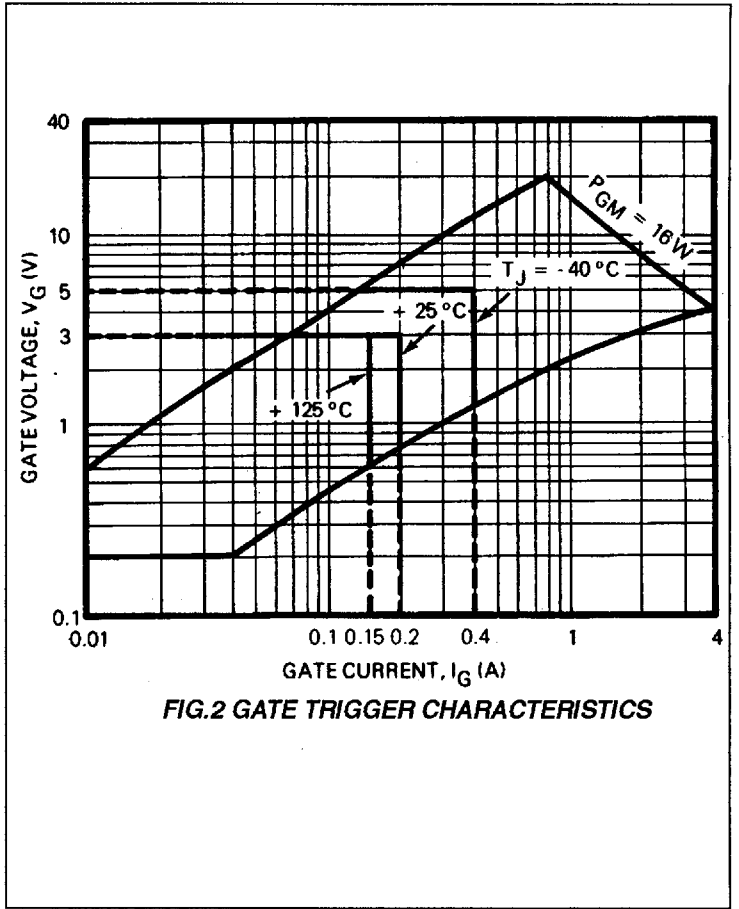
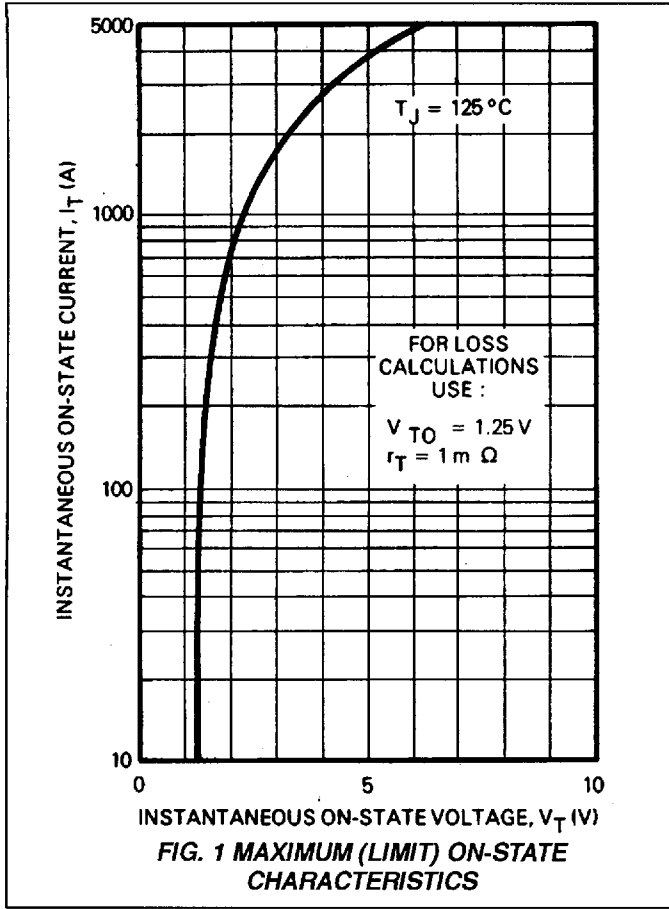

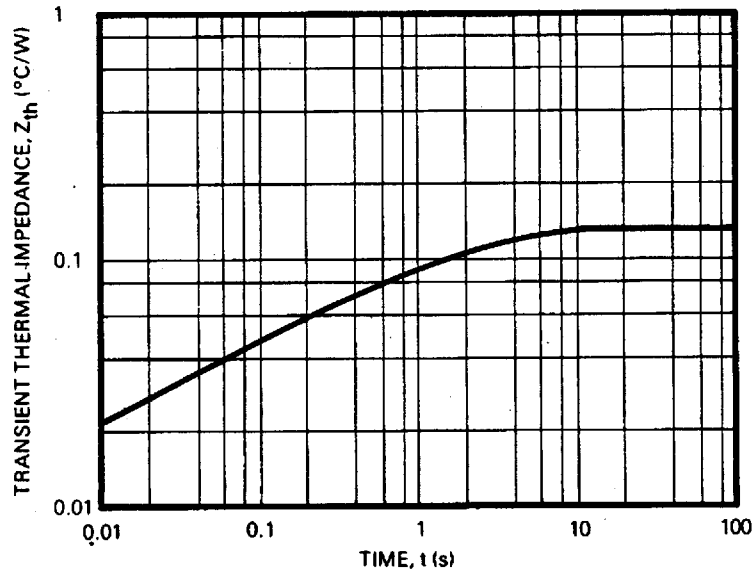

FIG. 4 TRANSIENT THERMAL IMPEDANCE - JUNCTION TO CASE

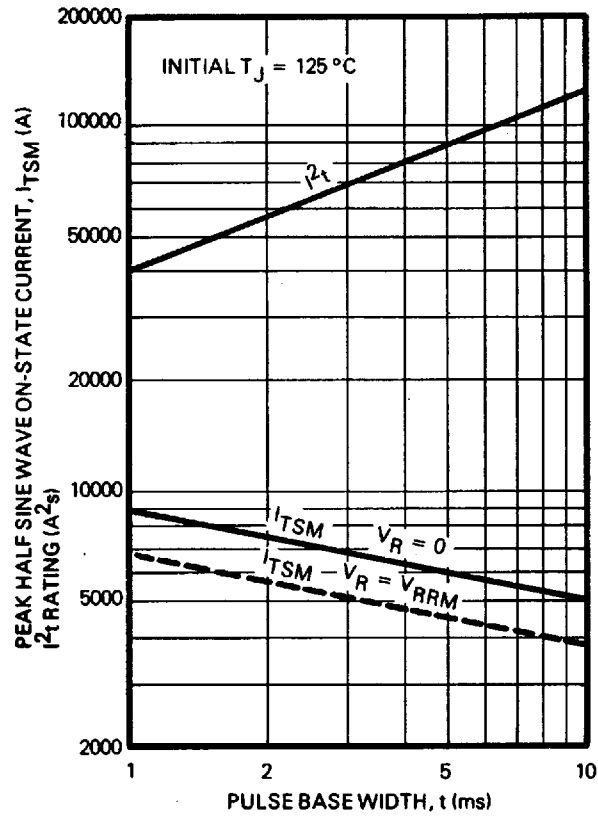

FIG. 5 NON-REPETITIVE SUB-CYCLE SURGE ON-STATE CURRENT AND I^2t RATING

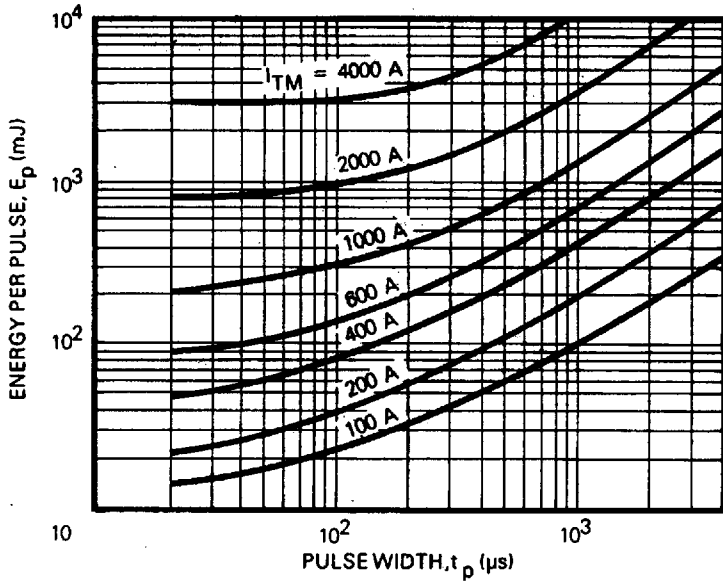

FIG. 6 ENERGY PER PULSE FOR SINUSOIDAL PULSES

NOTES:

1. $V_D \leq 600V$.
2. $V_R \leq 10V$.
3. R.C Snubber, $C = 0.22\mu F$, $R = 4.7\Omega$

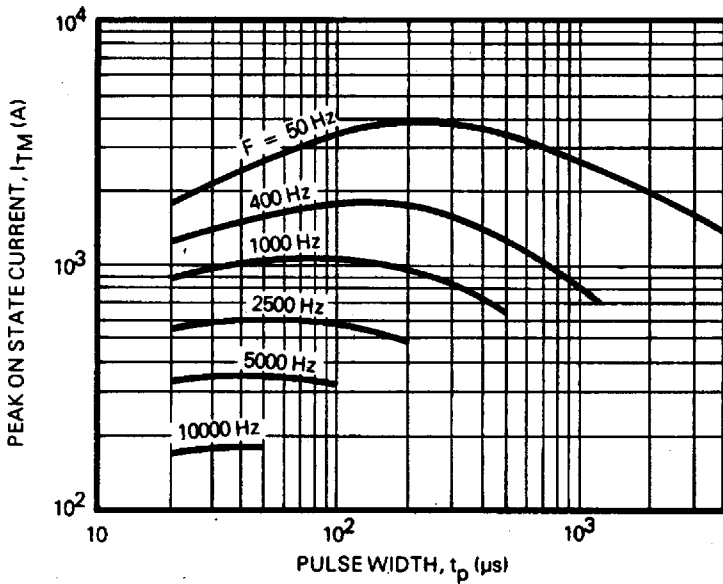
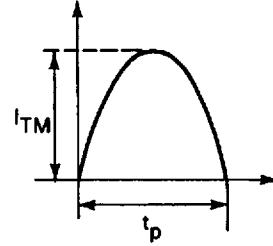
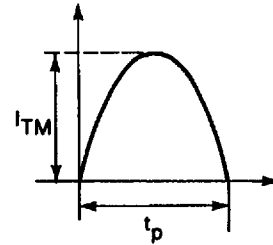

FIG. 7 MAXIMUM ALLOWABLE PEAK ON-STATE CURRENT vs PULSE WIDTH FOR $T_c = 65^\circ C$

NOTES:

1. $V_D \leq 600V$.
2. $V_R \leq 10V$.
3. R.C Snubber, $C = 0.22\mu F$, $R = 4.7\Omega$



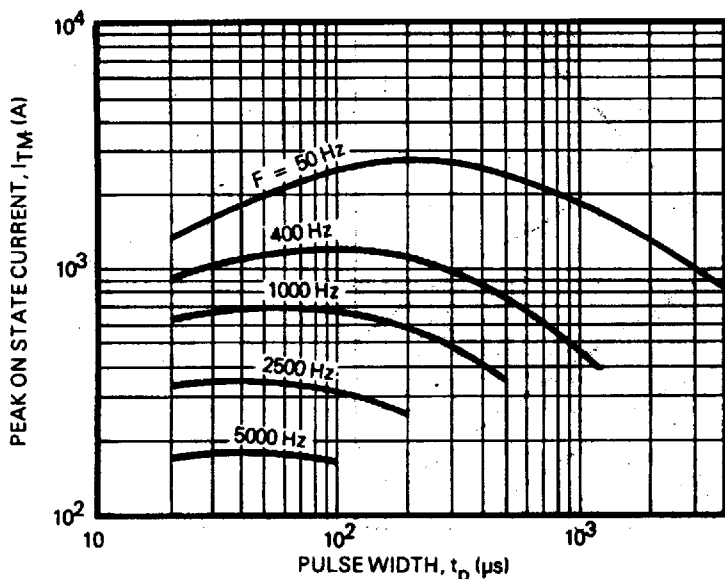

FIG. 8 MAXIMUM ALLOWABLE PEAK ON-STATE CURRENT vs PULSE WIDTH FOR $T_c = 90^\circ C$

NOTES:

1. $V_D \leq 600V$.
2. $V_R \leq 10V$.
3. R.C Snubber, $C = 0.22\mu F$, $R = 4.7\Omega$

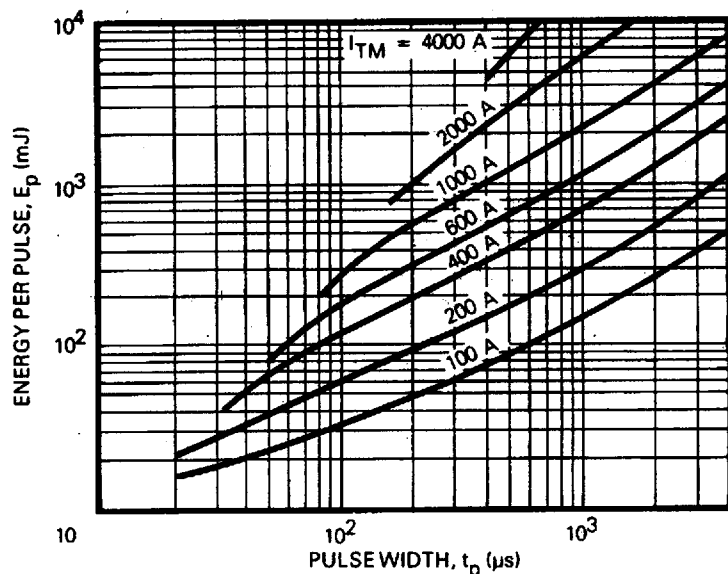
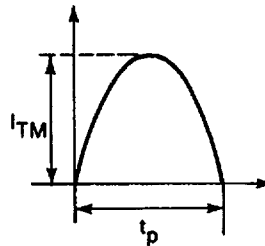
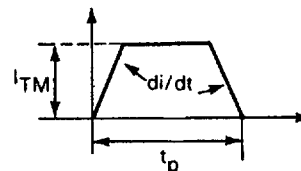

FIG. 9 ENERGY PER PULSE FOR TRAPEZOIDAL PULSES

NOTES:

1. $di/dt = 25A/\mu s$
2. $V_D \leq 600V$.
3. $V_R \leq 10V$.
4. R.C Snubber, $C = 0.22\mu F$, $R = 4.7\Omega$



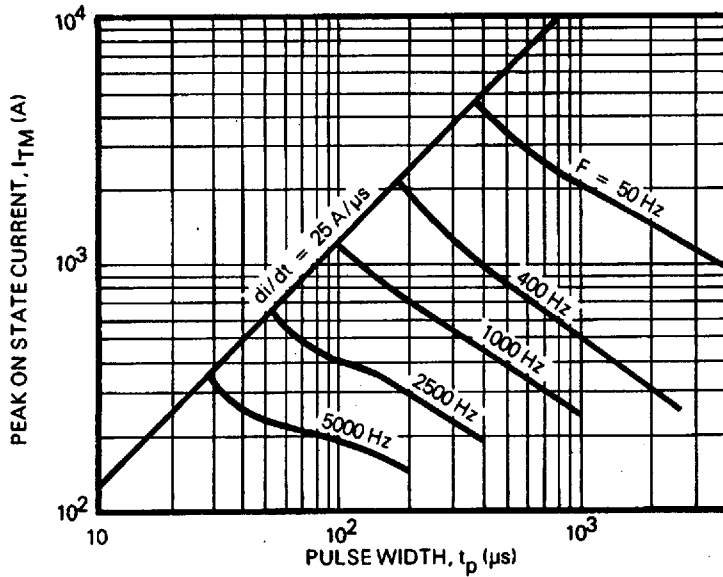

FIG. 10 MAXIMUM ALLOWABLE PEAK ON-STATE CURRENT vs PULSE WIDTH FOR $T_c = 65^\circ\text{C}$

NOTES:

1. $di/dt = 25\text{A}/\mu\text{s}$
2. $V_D \leq 600\text{V}$.
3. $V_R \leq 10\text{V}$.
4. R.C Snubber, $C = 0.22\mu\text{F}$, $R = 4.7\Omega$

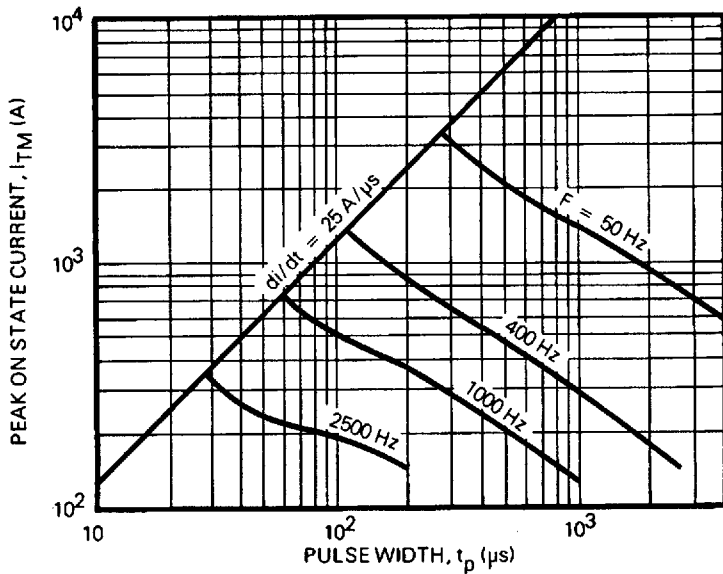
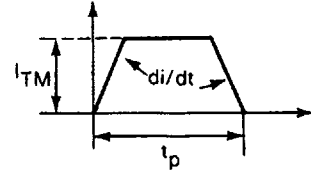
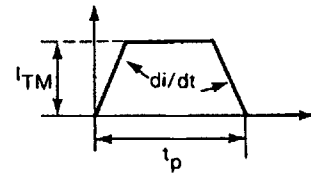

FIG. 11 MAXIMUM ALLOWABLE PEAK ON-STATE CURRENT vs PULSE WIDTH FOR $T_c = 90^\circ\text{C}$

NOTES:

1. $di/dt = 25\text{A}/\mu\text{s}$
2. $V_D \leq 600\text{V}$.
3. $V_R \leq 10\text{V}$.
4. R.C Snubber, $C = 0.22\mu\text{F}$, $R = 4.7\Omega$



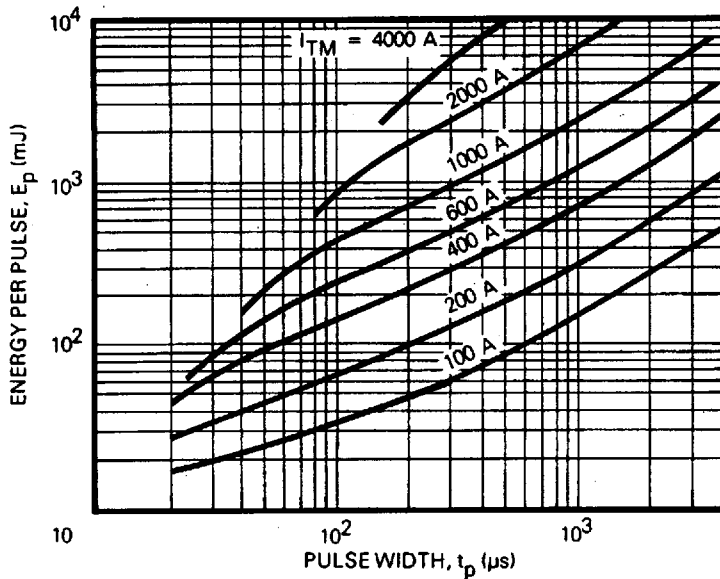

FIG. 12 ENERGY PER PULSE FOR TRAPEZOIDAL PULSES

NOTES:

1. $di/dt = 50A/\mu s$
2. $V_D \leq 600V$.
3. $V_R \leq 10V$.
4. R.C Snubber, $C = 0.22\mu F$, $R = 4.7\Omega$

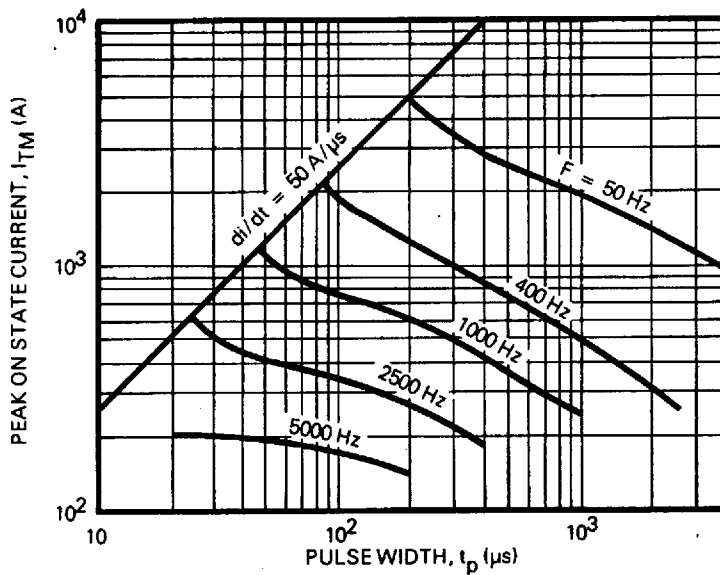
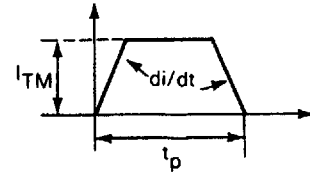
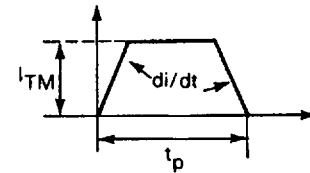

FIG. 13 MAXIMUM ALLOWABLE PEAK ON-STATE CURRENT vs PULSE WIDTH FOR $T_c = 65^\circ C$

NOTES:

1. $di/dt = 50A/\mu s$
2. $V_D \leq 600V$.
3. $V_R \leq 10V$.
4. R.C Snubber, $C = 0.22\mu F$, $R = 4.7\Omega$



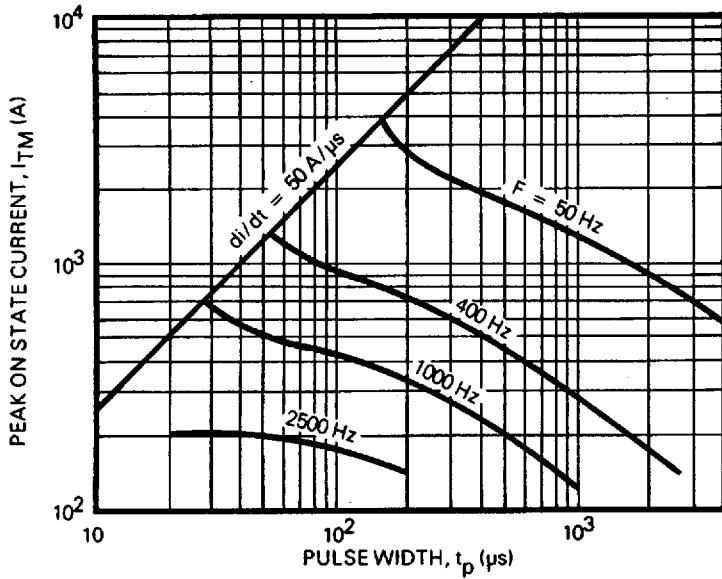

FIG. 14 MAXIMUM ALLOWABLE PEAK ON-STATE CURRENT vs PULSE WIDTH FOR $T_c = 90^\circ\text{C}$

NOTES:

1. $di/dt = 50\text{A}/\mu\text{s}$
2. $V_D \leq 600\text{V}$.
3. $V_R \leq 10\text{V}$.
4. R.C Snubber, $C = 0.22\mu\text{F}$, $R = 4.7\Omega$

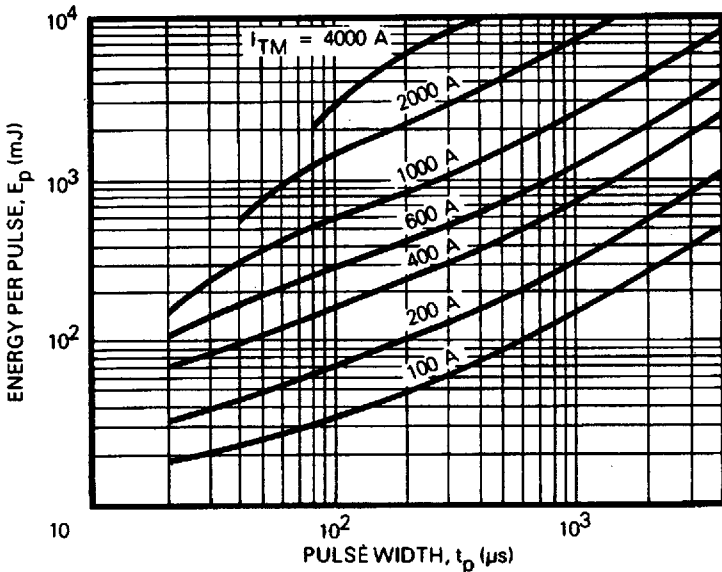
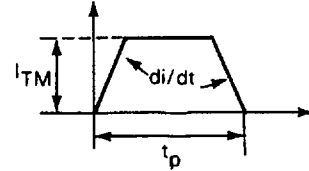
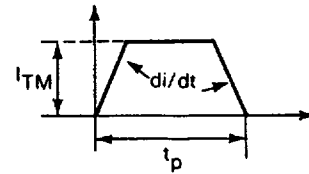

FIG. 15 ENERGY PER PULSE FOR TRAPEZOIDAL PULSES

NOTES:

1. $di/dt = 100\text{A}/\mu\text{s}$
2. $V_D \leq 600\text{V}$.
3. $V_R \leq 10\text{V}$.
4. R.C Snubber, $C = 0.22\mu\text{F}$, $R = 4.7\Omega$



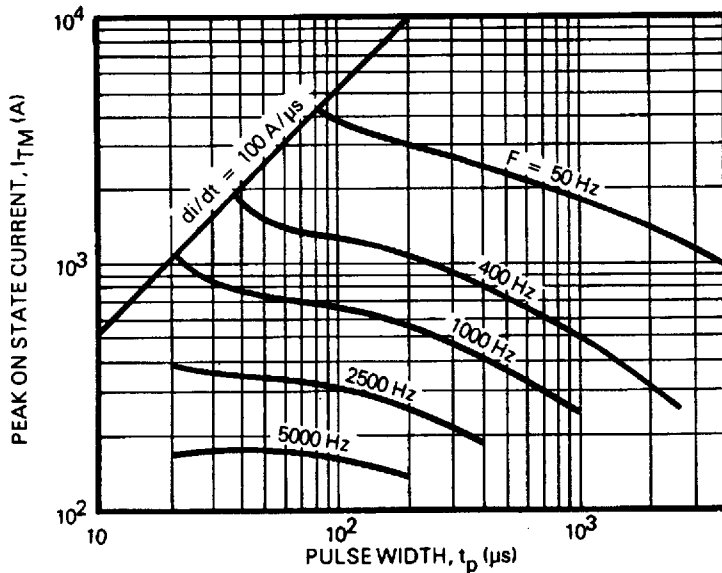

FIG. 16 MAXIMUM ALLOWABLE PEAK ON-STATE CURRENT vs PULSE WIDTH FOR $T_c = 65^\circ\text{C}$

NOTES:

1. $di/dt = 100\text{A}/\mu\text{s}$
2. $V_D \leq 600\text{V}$.
3. $V_R \leq 10\text{V}$.
4. R.C Snubber, $C = 0.22\mu\text{F}$, $R = 4.7\Omega$

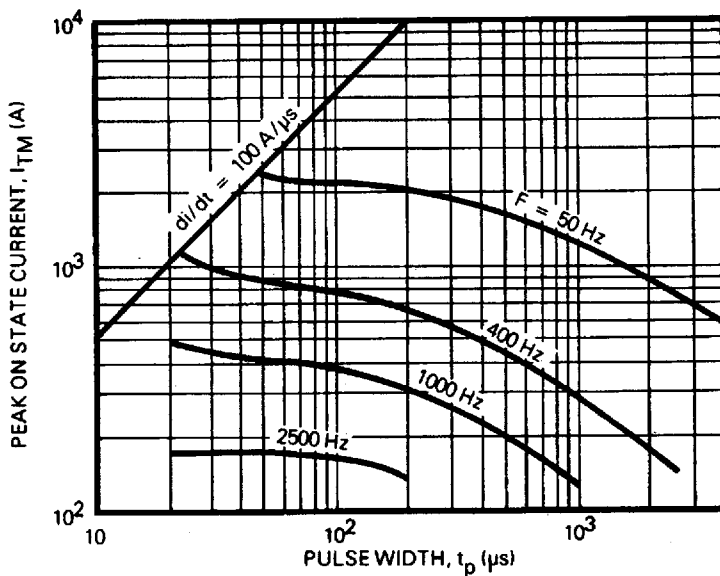
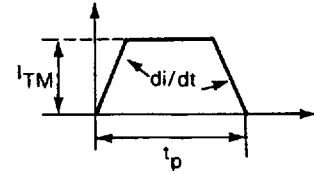
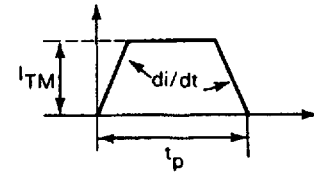

FIG. 17 MAXIMUM ALLOWABLE PEAK ON-STATE CURRENT vs PULSE WIDTH FOR $T_c = 90^\circ\text{C}$

NOTES:

1. $di/dt = 100\text{A}/\mu\text{s}$
2. $V_D \leq 600\text{V}$.
3. $V_R \leq 10\text{V}$.
4. R.C Snubber, $C = 0.22\mu\text{F}$, $R = 4.7\Omega$



PACKAGE DETAILS - TO93

For further package information, please contact your local Customer Service Centre. All dimensions in mm, unless stated otherwise. DO NOT SCALE.

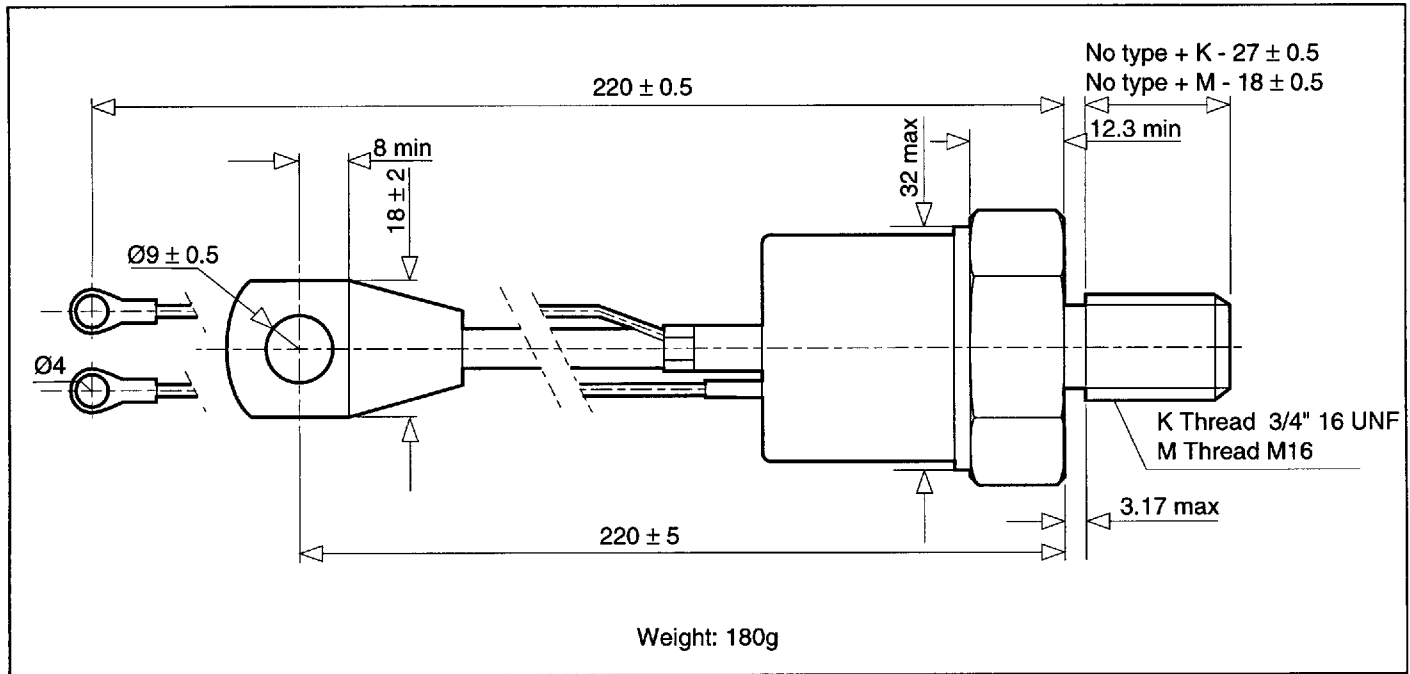

HEADQUARTERS OPERATIONS

GEC PLESSEY SEMICONDUCTORS

Cheney Manor, Swindon,
Wiltshire, SN2 2QW, United Kingdom.
Tel: + 44 (0)1793 518000
Fax: + 44 (0)1793 518411

GEC PLESSEY SEMICONDUCTORS

P.O. Box 660017
1500 Green Hills Road,
Scotts Valley, California 95067-0017,
United States of America.
Tel: + 1 (408) 438 2900
Fax: + 1 (408) 438 5576

POWER PRODUCT CUSTOMER SERVICE CENTRES

- **FRANCE.** 2 rue Henri-Bergson, 92665 Asnieres Cedex.
Tel: + 33 1 40 80 54 00. Fax: + 33 1 40 80 55 87.
- **GERMANY.** Ungererstrasse 129, 80505 München.
Tel: + 49 (0)89 36 09 060. Fax: + 49 (0)89 36 09 06 55.
- **NORTH AMERICA.** Two Dedham Place, Suite 125, 3 Allied Drive, Dedham. MA 02026.
Tel: + 1 617 251 0126. Fax: + 1 617 251 0106.
- **UNITED KINGDOM.** Doddington Road, Lincoln. LN6 3LF.
Tel: + 44 (0)1522 500500. Fax: + 44 (0)1522 500550.

These are supported by Agents and Distributors in major countries world-wide.

© GEC Plessey Semiconductors 1995 Publication No. DS4270-2 Issue No. 2.2 October 1995

TECHNICAL DOCUMENTATION - NOT FOR RESALE. PRINTED IN UNITED KINGDOM.

This publication is issued to provide information only which (unless agreed by the Company in writing) may not be used, applied or reproduced for any purpose nor form part of any order or contract nor to be regarded as a representation relating to the products or services concerned. No warranty or guarantee express or implied is made regarding the capability, performance or suitability of any product or service. The Company reserves the right to alter without prior notice the specification, design or price of any product or service. Information concerning possible methods of use is provided as a guide only and does not constitute any guarantee that such methods of use will be satisfactory in a specific piece of equipment. It is the user's responsibility to fully determine the performance and suitability of any equipment using such information and to ensure that any publication or data used is up to date and has not been superseded. These products are not suitable for use in any medical products whose failure to perform may result in significant injury or death to the user. All products and materials are sold and services provided subject to the Company's conditions of sale, which are available on request.