

Package Description	Part No.	C.C.orC.A.	Chip		Electro-optical Characteristics(Typ.)			Face Color
			Material	Emitting Color	λ P(nm)	V_f /Seg(V)	I_v /Seg(mcd)	
					20mA	20mA	10mA	
0.8"8×8DotMatrixDisplay	LMD08088CG-15	C.C.	GaP	Green	570	2.2	2.0	Black
	LMD08088DSR-15	C.A.	GaAlAs	HighRed	660	1.8	2.5	Black

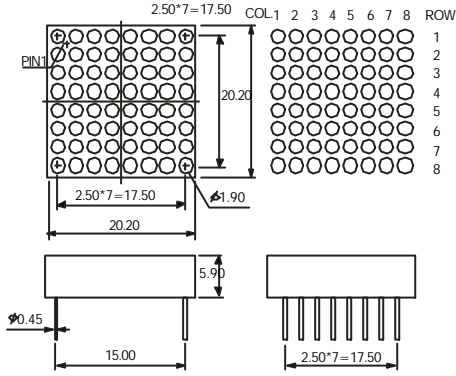

LMD08088C

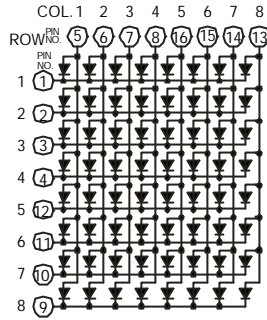

LMD08088D

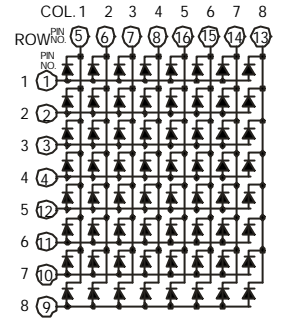

0.8"8×8Multi-Color DotMatrixDisplay	LMD08088AEG-15	C.C.	GaAsP/GaP	Red	635	2.0	2.2	Black
			GaP	Green	570	2.2	2.0	

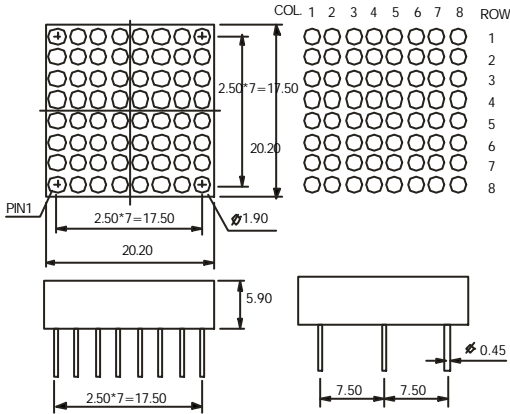

LMD08088A

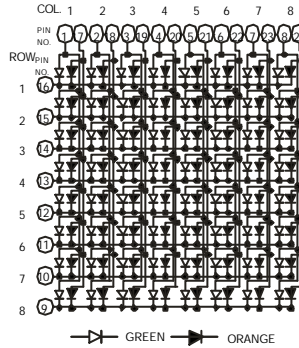

LMD08088B

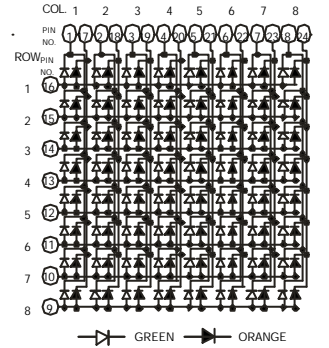

1.0"5×7DotMatrixDisplay	LMD10057AG-15	C.C.	GaP	Green	570	2.2	2.0	Black
	LMD10057BSR-15	C.A.	GaAlAs	HighRed	660	1.8	2.5	Black

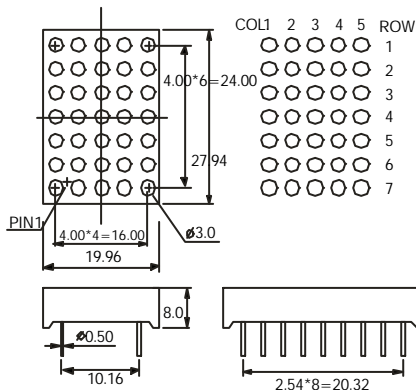

LMD10057A

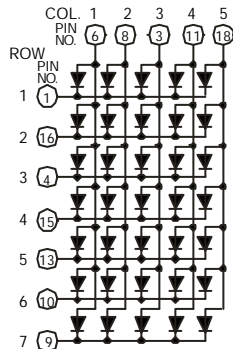

LMD10057B

