

Data sheet | Item number: 859-759

Optocoupler module; Nominal input voltage: 24 VDC; Output voltage range: 20 ... 28.8 VDC; Limiting continuous current: 0.1 A; 3-wire connection/high-side switching; Frequency: 100 kHz; Red status indicator; Module width: 6 mm

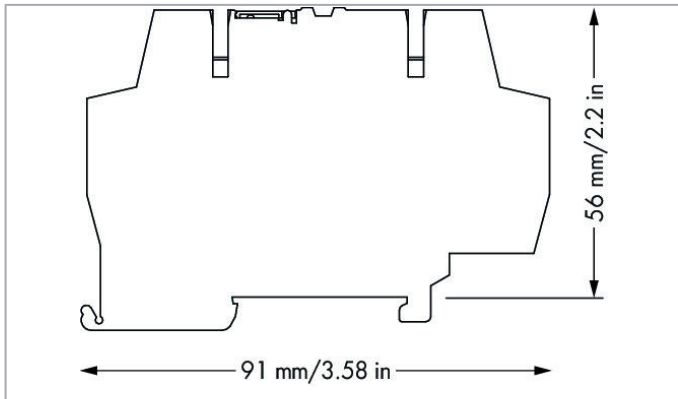

www.wago.com/859-759

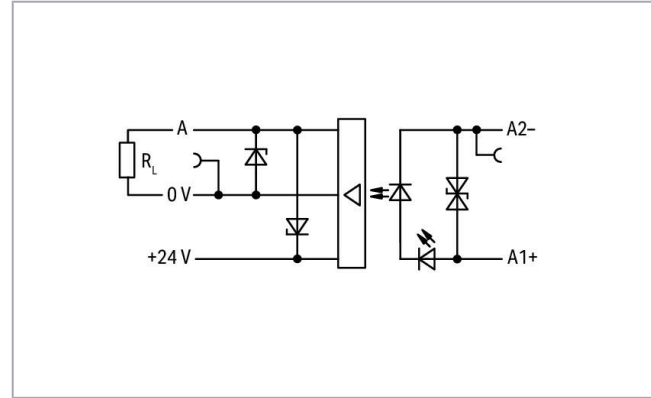
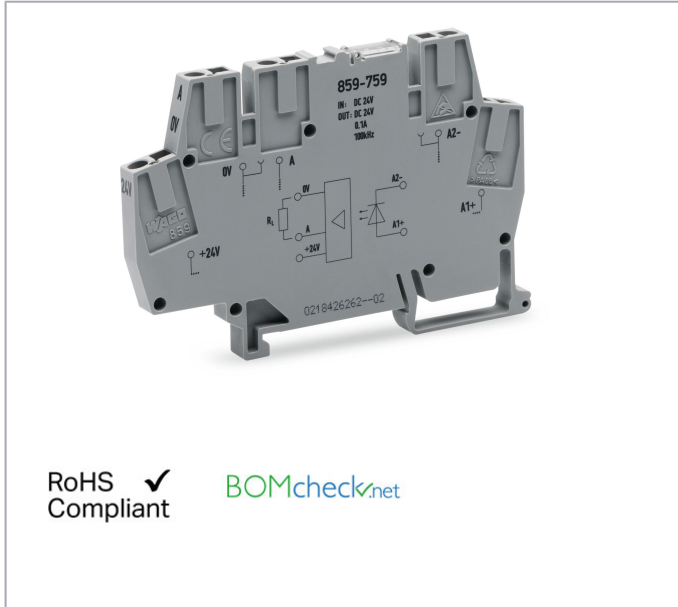

Item description

Note:

Optocouplers and solid state relays are designed for use in signal processing networks, which are not supplied by the low-voltage power supply networks.

Data

Technical data

Subject to changes. Please also observe the further product documentation!

WAGO Kontakttechnik GmbH & Co. KG
Hansastr. 27
32423 Minden
Phone: +49571 887-0 | Fax: +49571 887-169
Email: info.de@wago.com | Web: www.wago.com

Do you have any questions about our products?
We are always happy to take your call at +49 (571) 887-44222.

Control circuit

Nominal input voltage U_N	DC 24 V
Input voltage range (low level)	DC 0 ... 5 V
Input voltage range (high level)	DC 20 ... 30 V
Nominal input current at U_N	9 mA

Load circuit

Circuit type	3-wire connection High-side switching
Limiting continuous current	0.1 A
Peak output current	0.8 A
Nominal output voltage	DC 24 V
Output voltage range	DC 20 ... 28.8 V
Voltage drop at output (max.)	\leq DC 1.2 V
Leakage current at rated voltage	\leq 10 μ A
Output closed-circuit current (without load) (max.)	7 mA
Turn-on time	\leq 0.5 μ s
Turn-off time	\leq 2 μ s
Switching frequency	\leq 100 kHz

Signaling

Status indicator	Red LED
------------------	---------

Safety and protection

Rated voltage	300 V
Overvoltage category	II
Pollution degree	2
Dielectric strength, control/load circuit (AC, 1 min)	2.5 kVrms
Insulation type (control/load circuit)	Basic insulation
Insulation type (adjacent devices)	Reinforced insulation (safe isolation)

Connection data

Connection technology	CAGE CLAMP®
Solid conductor	0.08 ... 2.5 mm ² / 28 ... 14 AWG
Fine-stranded conductor	0.08 ... 2.5 mm ² / 28 ... 14 AWG

Subject to changes. Please also observe the further product documentation!

Strip length	5 ... 6 mm / 0.2 ... 0.24 inch
--------------	--------------------------------

Physical data

Width	6 mm / 0.236 inch
Height from upper-edge of DIN-rail	56 mm / 2.205 inch
Depth	91 mm / 3.583 inch

Mechanical data

Mounting type	DIN-35 rail
---------------	-------------

Material data

Fire load	0.313 MJ
Weight	19.1 g

Environmental requirements

Surrounding air temperature (operation at U_N)	-25 ... 55 °C
Surrounding air temperature (storage)	-40 ... 70 °C
Processing temperature	-25 ... +50 °C
Relative humidity	5 ... 95 % (no condensation permissible)
Operating altitude (max.)	2000 m

Standards and specifications

Standards/Specifications	EN 61010-2-201; EN 61000-6-2; EN 61000-6-3; EN 61373
--------------------------	--

Commercial data

Product Group	6 (Interface Electronics)
Packaging type	BOX
Country of origin	DE
GTIN	4055143606141
Customs tariff number	85365005000

Compatible products

check



Item no.: 859-500

Test pin; 1 mm Ø; with solder connection for test wire

www.wago.com/859-500

Subject to changes. Please also observe the further product documentation!

tools

**Item no.: 210-720**

Operating tool; Blade: 3.5 x 0.5 mm; with a partially insulated shaft; multicoloured

www.wago.com/210-720

Marking accessories

**Item no.: 2009-145**

Mini-WSB Inline; for Smart Printer; 1700 pieces on roll; stretchable 5 - 5.2 mm; plain; snap-on type; white

www.wago.com/2009-145**Item no.: 2009-145/000-002**

Mini-WSB Inline; for Smart Printer; 1700 pieces on roll; stretchable 5 - 5.2 mm; plain; snap-on type; yellow

www.wago.com/2009-145/000-002**Item no.: 2009-145/000-005**

Mini-WSB Inline; for Smart Printer; 1700 pieces on roll; stretchable 5 - 5.2 mm; plain; snap-on type; red

www.wago.com/2009-145/000-005**Item no.: 2009-145/000-006**

Mini-WSB Inline; for Smart Printer; 1700 pieces on roll; stretchable 5 - 5.2 mm; plain; snap-on type; blue

www.wago.com/2009-145/000-006**Item no.: 2009-145/000-007**

Mini-WSB Inline; for Smart Printer; 1700 pieces on roll; stretchable 5 - 5.2 mm; plain; snap-on type; gray

www.wago.com/2009-145/000-007**Item no.: 2009-145/000-012**

Mini-WSB Inline; for Smart Printer; 1700 pieces on roll; stretchable 5 - 5.2 mm; plain; snap-on type; orange

www.wago.com/2009-145/000-012**Item no.: 2009-145/000-023**

Mini-WSB Inline; for Smart Printer; 1700 pieces on roll; stretchable 5 - 5.2 mm; plain; snap-on type; green

www.wago.com/2009-145/000-023**Item no.: 2009-145/000-024**

Mini-WSB Inline; for Smart Printer; 1700 pieces on roll; stretchable 5 - 5.2 mm; plain; snap-on type; violet

www.wago.com/2009-145/000-024**Item no.: 210-110**

Fiber-tip pen

www.wago.com/210-110**Item no.: 248-501**

Miniature WSB Quick marking system; plain; Marker width 5 mm; 10 strips with 10 markers per card

www.wago.com/248-501**Item no.: 248-501/000-002**

Mini-WSB marking card; as card; not stretchable; plain; snap-on type; yellow

www.wago.com/248-501/000-002**Item no.: 248-501/000-005**

Mini-WSB marking card; as card; not stretchable; plain; snap-on type; red

www.wago.com/248-501/000-005**Item no.: 248-501/000-006**

Mini-WSB marking card; as card; not stretchable; plain; snap-on type; blue

www.wago.com/248-501/000-006

Subject to changes. Please also observe the further product documentation!

WAGO Kontakttechnik GmbH & Co. KG

Hansastr. 27

32423 Minden

Phone: +49571 887-0 | Fax: +49571 887-169

Email: info.de@wago.com | Web: www.wago.com

Do you have any questions about our products?

We are always happy to take your call at +49 (571) 887-44222.

	Item no.: 248-501/000-007 Mini-WSB marking card; as card; not stretchable; plain; snap-on type; gray	www.wago.com/248-501/000-007
--	--	--

	Item no.: 248-501/000-012 Mini-WSB marking card; as card; not stretchable; plain; snap-on type; orange	www.wago.com/248-501/000-012
--	--	--

	Item no.: 248-501/000-017 Mini-WSB marking card; as card; not stretchable; plain; snap-on type; light green	www.wago.com/248-501/000-017
--	---	--

	Item no.: 248-501/000-023 Mini-WSB marking card; as card; not stretchable; plain; snap-on type; green	www.wago.com/248-501/000-023
--	---	--

	Item no.: 248-501/000-024 Mini-WSB marking card; as card; not stretchable; plain; snap-on type; violet	www.wago.com/248-501/000-024
--	--	--

	Item no.: 248-502 Mini-WSB marking card; as card; MARKED; 1 ... 10 (10x); not stretchable; Horizontal marking; snap-on type; white	www.wago.com/248-502
--	--	--

	Item no.: 248-502/000-024 Mini-WSB marking card; as card; MARKED; 1 ... 10 (10x); not stretchable; Horizontal marking; snap-on type; violet	www.wago.com/248-502/000-024
--	---	--

	Item no.: 248-503 Mini-WSB marking card; as card; MARKED; 11 ... 20 (10x); not stretchable; Horizontal marking; snap-on type; white	www.wago.com/248-503
--	---	--

	Item no.: 248-503/000-024 Mini-WSB marking card; as card; MARKED; 11 ... 20 (10x); not stretchable; Horizontal marking; snap-on type; violet	www.wago.com/248-503/000-024
--	--	--

	Item no.: 248-504 Mini-WSB marking card; as card; MARKED; 21 ... 30 (10x); not stretchable; Horizontal marking; snap-on type; white	www.wago.com/248-504
--	---	--

	Item no.: 248-504/000-024 Mini-WSB marking card; as card; MARKED; 21 ... 30 (10x); not stretchable; Horizontal marking; snap-on type; violet	www.wago.com/248-504/000-024
--	--	--

	Item no.: 248-505/000-024 Mini-WSB marking card; as card; MARKED; 31 ... 40 (10x); not stretchable; Horizontal marking; snap-on type; violet	www.wago.com/248-505/000-024
--	--	--





	Item no.: 248-506 Mini-WSB marking card; as card; MARKED; 41 ... 50 (10x); not stretchable; Horizontal marking; snap-on type; white	www.wago.com/248-506
--	---	--

End plate









	Item no.: 859-525 End and intermediate plate; 1 mm thick; gray	www.wago.com/859-525
--	--	--

Subject to changes. Please also observe the further product documentation!









ferrule

	Item no.: 216-221 Ferrule; Sleeve for 0.5 mm ² / 20 AWG; insulated; electro-tin plated; white	www.wago.com/216-221
	Item no.: 216-222 Ferrule; Sleeve for 0.75 mm ² / 18 AWG; insulated; electro-tin plated; gray	www.wago.com/216-222
	Item no.: 216-223 Ferrule; Sleeve for 1 mm ² / AWG 18; insulated; electro-tin plated; red	www.wago.com/216-223
	Item no.: 216-224 Ferrule; Sleeve for 1.5 mm ² / AWG 16; insulated; electro-tin plated; black	www.wago.com/216-224
	Item no.: 216-321 Ferrule; Sleeve for 0.25 mm ² / AWG 24; insulated; electro-tin plated; yellow	www.wago.com/216-321
	Item no.: 216-322 Ferrule; Sleeve for 0.34 mm ² / 22 AWG; insulated; electro-tin plated; green	www.wago.com/216-322

Jumper

	Item no.: 859-402 Jumper; for jumper slot; 2-way; insulated; light gray	www.wago.com/859-402
	Item no.: 859-402/000-005 Jumper; for jumper slot; 2-way; insulated; red	www.wago.com/859-402/000-005
	Item no.: 859-402/000-006 Jumper; for jumper slot; 2-way; insulated; blue	www.wago.com/859-402/000-006
	Item no.: 859-402/000-029 Jumper; for jumper slot; 2-way; insulated; yellow	www.wago.com/859-402/000-029
	Item no.: 859-403 Jumper; for jumper slot; 3-way; insulated; light gray	www.wago.com/859-403
	Item no.: 859-403/000-005 Jumper; for jumper slot; 3-way; insulated; red	www.wago.com/859-403/000-005
	Item no.: 859-403/000-006 Jumper; for jumper slot; 3-way; insulated; blue	www.wago.com/859-403/000-006
	Item no.: 859-403/000-029 Jumper; for jumper slot; 3-way; insulated; yellow	www.wago.com/859-403/000-029
	Item no.: 859-404 Jumper; for jumper slot; 4-way; insulated; light gray	www.wago.com/859-404

Subject to changes. Please also observe the further product documentation!

	Item no.: 859-404/000-005 Jumper; for jumper slot; 4-way; insulated; red	www.wago.com/859-404/000-005
	Item no.: 859-404/000-006 Jumper; for jumper slot; 4-way; insulated; blue	www.wago.com/859-404/000-006
	Item no.: 859-404/000-029 Jumper; for jumper slot; 4-way; insulated; yellow	www.wago.com/859-404/000-029
	Item no.: 859-405 Jumper; for jumper slot; 5-way; insulated; light gray	www.wago.com/859-405
	Item no.: 859-405/000-005 Jumper; for jumper slot; 5-way; insulated; red	www.wago.com/859-405/000-005
	Item no.: 859-405/000-006 Jumper; for jumper slot; 5-way; insulated; blue	www.wago.com/859-405/000-006
	Item no.: 859-405/000-029 Jumper; for jumper slot; 5-way; insulated; yellow	www.wago.com/859-405/000-029
	Item no.: 859-406 Jumper; for jumper slot; 6-way; insulated; light gray	www.wago.com/859-406
	Item no.: 859-406/000-005 Jumper; for jumper slot; 6-way; insulated; red	www.wago.com/859-406/000-005
	Item no.: 859-406/000-006 Jumper; for jumper slot; 6-way; insulated; blue	www.wago.com/859-406/000-006
	Item no.: 859-406/000-029 Jumper; for jumper slot; 6-way; insulated; signal yellow	www.wago.com/859-406/000-029
	Item no.: 859-407 Jumper; for jumper slot; 7-way; insulated; light gray	www.wago.com/859-407
	Item no.: 859-407/000-005 Jumper; for jumper slot; 7-way; insulated; red	www.wago.com/859-407/000-005
	Item no.: 859-407/000-006 Jumper; for jumper slot; 7-way; insulated; blue	www.wago.com/859-407/000-006

Subject to changes. Please also observe the further product documentation!



Item no.: 859-407/000-029
Jumper; for jumper slot; 7-way; insulated; yellow

www.wago.com/859-407/000-029



Item no.: 859-408
Jumper; for jumper slot; 8-way; insulated; light gray

www.wago.com/859-408



Item no.: 859-408/000-005
Jumper; for jumper slot; 8-way; insulated; red

www.wago.com/859-408/000-005



Item no.: 859-408/000-006
Jumper; for jumper slot; 8-way; insulated; blue

www.wago.com/859-408/000-006



Item no.: 859-408/000-029
Jumper; for jumper slot; 8-way; insulated; yellow

www.wago.com/859-408/000-029



Item no.: 859-409
Jumper; for jumper slot; 9-way; insulated; light gray

www.wago.com/859-409



Item no.: 859-409/000-005
Jumper; for jumper slot; 9-way; insulated; red

www.wago.com/859-409/000-005



Item no.: 859-409/000-006
Jumper; for jumper slot; 9-way; insulated; blue

www.wago.com/859-409/000-006



Item no.: 859-409/000-029
Jumper; for jumper slot; 9-way; insulated; yellow

www.wago.com/859-409/000-029



Item no.: 859-410
Jumper; for jumper slot; 10-way; insulated; light gray

www.wago.com/859-410



Item no.: 859-410/000-005
Jumper; for jumper slot; 10-way; insulated; red

www.wago.com/859-410/000-005

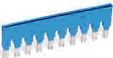

Item no.: 859-410/000-006
Jumper; for jumper slot; 10-way; insulated; blue

www.wago.com/859-410/000-006



Item no.: 859-410/000-029
Jumper; for jumper slot; 10-way; insulated; yellow

www.wago.com/859-410/000-029

Subject to changes. Please also observe the further product documentation!



Downloads

Documentation

Bid Text

859-759 X81 - Datei	2019 Feb 19	xml 3.9 kB	Download
------------------------	-------------	---------------	----------

859-759 docx - Datei	2019 Feb 20	docx 15.9 kB	Download
-------------------------	-------------	-----------------	----------

Instruction Leaflet

Relay modules, Optocoupler modules	V 1.2.0 2019 Aug 30	pdf 2.2 MB	Download
------------------------------------	------------------------	---------------	----------

Additional Information

Disposal; Electrical and electronic equipment, Packaging	V 1.0.0	pdf 265.8 kB	Download
--	---------	-----------------	----------

CAD/CAE-Data

CAD data

2D/3D Models 859-759	URL	Download
----------------------	-----	----------

CAE data

EPLAN Data Portal 859-759	URL	Download
---------------------------	-----	----------

WSCAD Universe 859-759	URL	Download
------------------------	-----	----------

ZUKEN Portal 859-759	URL	Download
----------------------	-----	----------

Environmental Product Compliance

Compliance Search

Environmental Product Compliance 859-759	URL	Download
--	-----	----------

Optocoupler module; Nominal input voltage: 24 VDC; Output voltage range: 20 ... 28.8 VDC; Limiting continuous current: 0.1 A; 3-wire connection/high-side switching; Frequency: 100 kHz; Red status indicator; Module width: 6 mm

Subject to changes. Please also observe the further product documentation!

Installation Notes

Conductor termination

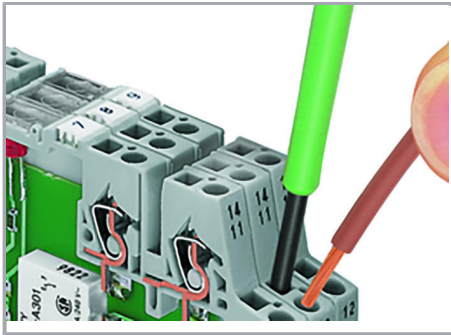

Connection of conductor

Commoning

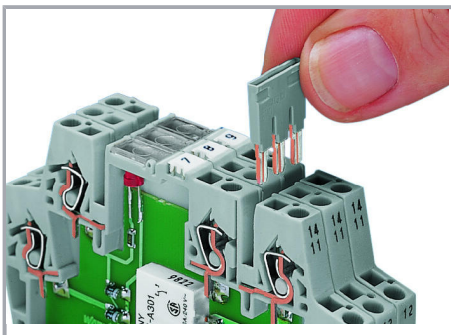

Easy commoning using adjacent jumpers

Marking

Subject to changes. Please also observe the further product documentation!



Marking using miniature WSB quick marking card

Subject to changes. Please also observe the further product documentation!