



LED Display Product Data Sheet LTC-37C1KG

Spec No.: DS30-2011-0190

Effective Date: 02/07/2012

Revision: -

LITE-ON DCC

RELEASE

BNS-OD-FC001/A4



LED DISPLAY

LTC-37C1KG

DATA SHEET

| ITEM | DESCRIPTION | ISSUER | DATE |
|-------------|--------------------|---------------|-------------|
| 1 | New Spec. | Reo Lin | 09/16/2011 |
| | | | |
| | | | |
| | | | |
| | | | |
| | | | |
| | | | |
| | | | |

FEATURES

- * 0.36 inch (9.2 mm) DIGIT HEIGHT
- * CONTINUOUS UNIFORM SEGMENTS
- * LOW POWER REQUIREMENT
- * EXCELLENT CHARACTERS APPEARANCE
- * HIGH BRIGHTNESS & HIGH CONTRAST
- * WIDE VIEWING ANGLE
- * SOLID STATE RELIABILITY
- * CATEGORIZED FOR LUMINOUS INTENSITY
- * **LEAD-FREE PACKAGE (ACCORDING TO ROHS)**

DESCRIPTION

The LTC-37C1KG is a 0.36inch (9.2 mm) height digit display. The devices utilize AlInGaP Green LED chips, which are made from AlInGaP on a non-transparent GaAs substrate, and has a black face and white segments.

DEVICE

| PART NO. | DESCRIPTION |
|-----------------|--------------------|
| AlInGaP green | COMMON CATHODE |
| LTC-37C1KG | |

PACKAGE DIMENSIONS

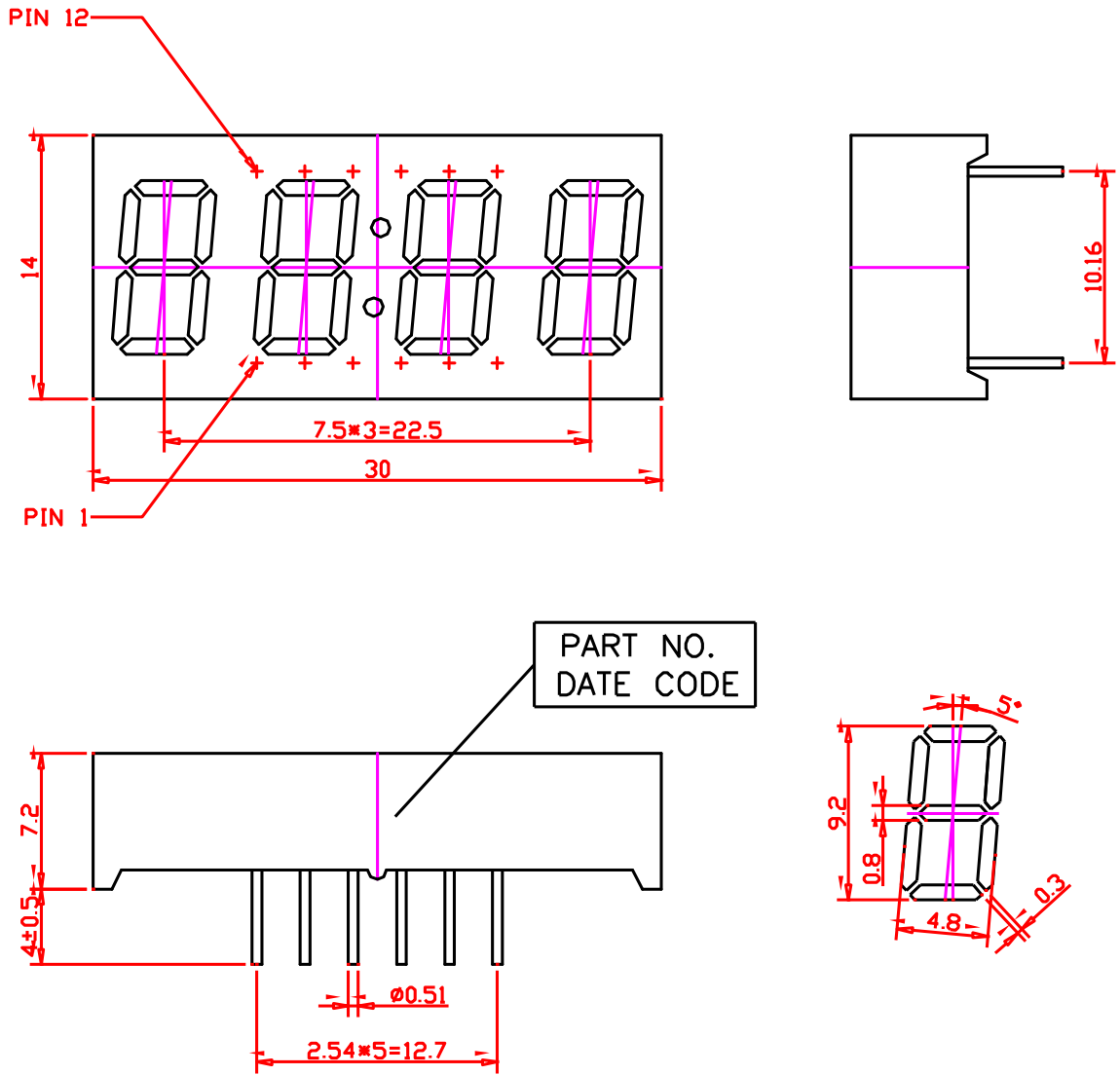

- NOTES: 1). All dimensions are in millimeters. Tolerances are ± 0.25 mm (0.01") unless otherwise noted.
 2). Pin tip's shift tolerance is ± 0.4 mm. (suggest mother board pin hole $\psi 1.0$ mm)

INTERNAL CIRCUIT DIAGRAM

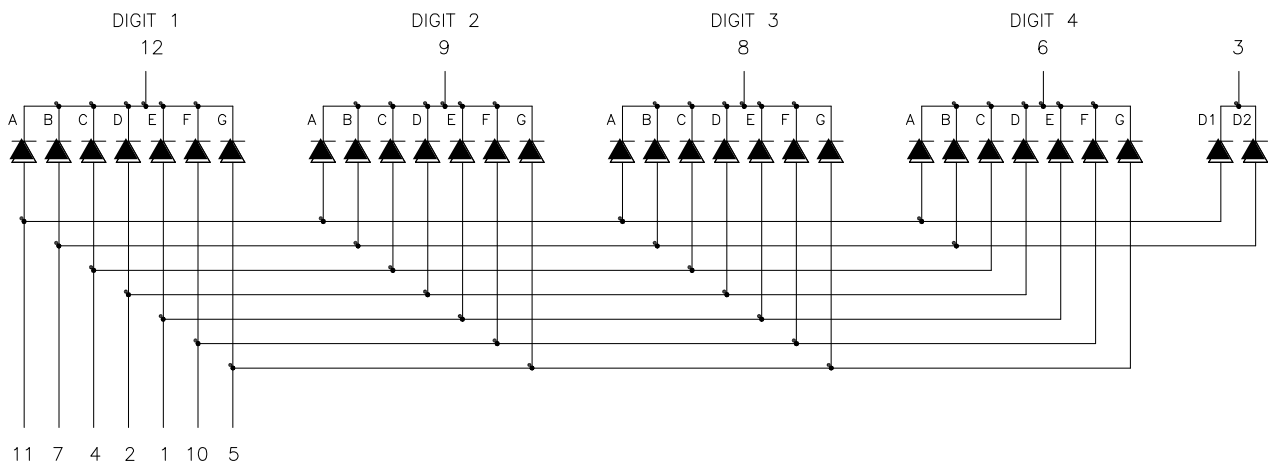
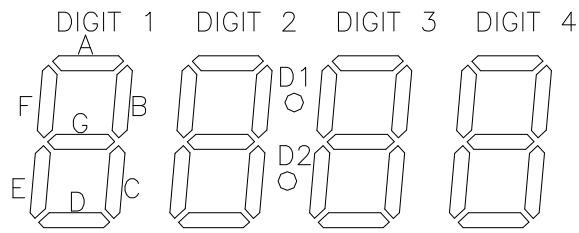

PIN CONNECTION

| No. | CONNECTION |
|------------|------------------------|
| 1 | Anode E |
| 2 | Anode D |
| 3 | Common Cathode D1,D2 |
| 4 | Anode C |
| 5 | Anode G |
| 6 | Common Cathode Digit 4 |
| 7 | Anode B,D2 |
| 8 | Common Cathode Digit 3 |
| 9 | Common Cathode Digit 2 |
| 10 | Anode F |
| 11 | Anode A,D1 |
| 12 | Common Cathode Digit 1 |

ABSOLUTE MAXIMUM RATING AT T_A=25°C

| PARAMETER | MAXIMUM RATING | UNIT |
|---|------------------|-------|
| Power Dissipation Per Chip | 70 | mW |
| Peak Forward Current Per Chip (1/10 Duty Cycle, 0.1ms Pulse Width) | 60 | mA |
| Continuous Forward Current Per Chip | 25 | mA |
| Derating Linear From 25 °C Per Chip | 0.33 | mA/°C |
| Operating Temperature Range | -35 °C to +85 °C | |
| Storage Temperature Range | -35 °C to +85 °C | |
| Solder Temperature: max 260°C for max 3sec at 1.6mm below seating plane | | |

TYPICAL / OPTICAL CHARACTERISTICS AT T_A=25°C

| PARAMETER | SYMBOL | MIN. | TYP. | MAX. | UNIT | TEST CONDITION |
|--|-------------------|------|------|------|------|----------------------|
| Average Luminous Intensity | I _v | 200 | 585 | | μcd | I _F =1mA |
| | | | 6435 | | μcd | I _F =10mA |
| Peak Emission Wavelength | λ _p | | 571 | | nm | I _F =20mA |
| Spectral Line Half-Width | Δλ | | 15 | | nm | I _F =20mA |
| Dominant Wavelength | λ _d | | 572 | | nm | I _F =20mA |
| Forward Voltage Per Segment | V _F | | 2.05 | 2.6 | V | I _F =20mA |
| Reverse Current Per Segment ⁽²⁾ | I _R | | | 100 | μA | V _R =5V |
| Luminous Intensity Matching Ratio | I _v -m | | | 2:1 | | I _F =1mA |

Note:

- Luminous intensity is measured with a light sensor and filter combination that approximates the CIE (Commision Internationale De L'Eclairage) eye-response curve.
- Reverse voltage is only for IR test. It can not continue to operate at this situation.

TYPICAL ELECTRICAL / OPTICAL CHARACTERISTIC CURVES
 (25°C Ambient Temperature Unless Otherwise Noted)

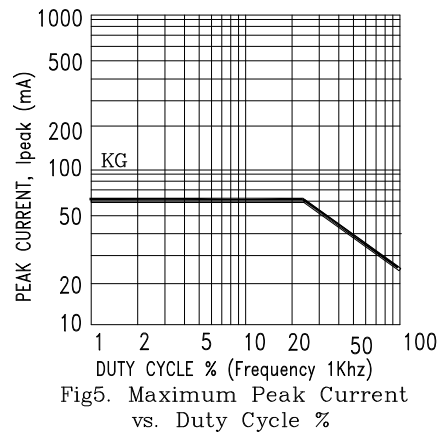
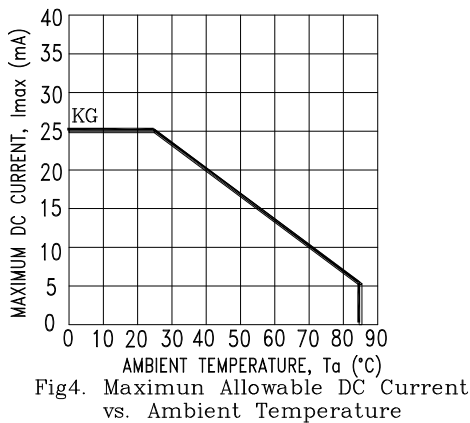
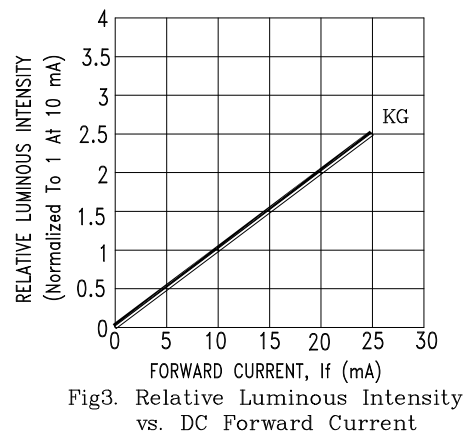
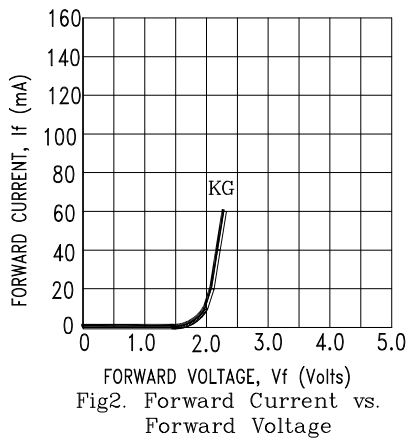
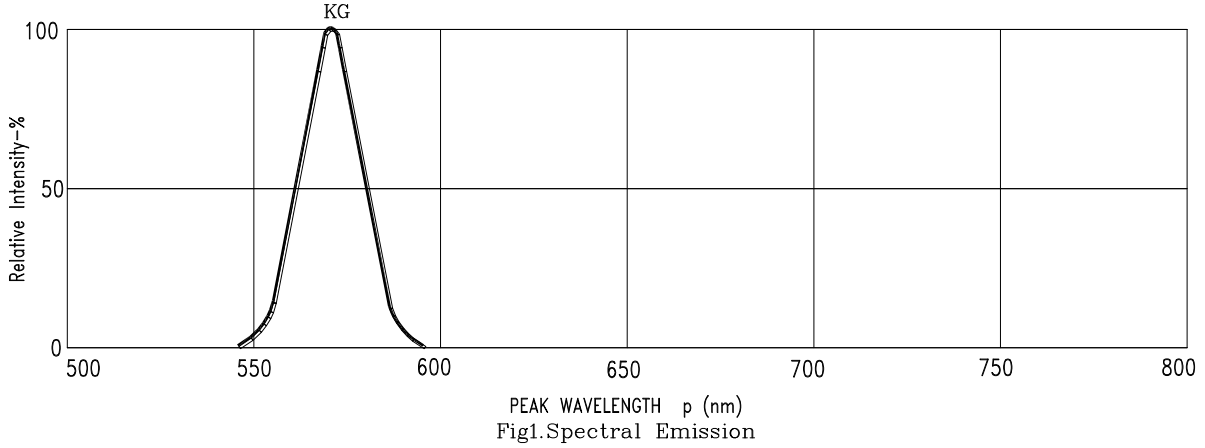

NOTE : KG=AlInGaP Green