

## 5-MODE PRESET EQUALIZER WITH LF BOOST 3D EFFECTS

### DESCRIPTION

The SC5389 is a 2-channel digital preset equalizer utilizing CMOS technology. It provides 5 different sound selections, namely: Flat/Normal, Rock, Pops, Classic and Jazz. Bass Booster and 3D Effects may be added to any of 5 sound selections, thereby creating more audio versatility. SC5389 provides two types of key selection mode, namely: the Direct and the Cyclic. Pin assignment and application circuit are optimized for cost saving advantages and easy PCB layout.

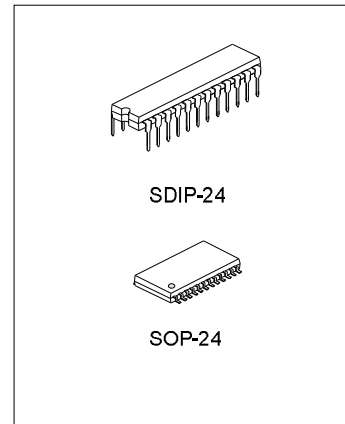

### FEATURES

- \* CMOS Technology
- \* Low Total Harmonic Distortion and High S/N Ratio:  
THD+N<0.01%, S/N>95dB
- \* LED Display Output Mode
- \* 5 Sound Selections Provided: Flat/Normal, Classic, Rock, Pops, and Jazz
- \* Bass Booster Function & 3D Effect Provided
- \* 2-Channel Output
- \* Wide Operating Voltage Range: 5 – 9 V
- \* Direct or Cyclic Key Selection is Provided

### ORDERING INFORMATION

Device	Package
SC5389	SDIP-24--300-2.54
SC5389S	SOP-24--375-1.27

### APPLICATIONS

- \* Car Audio
- \* Mini compo
- \* Multimedia Audio Components

### BLOCK DIAGRAM

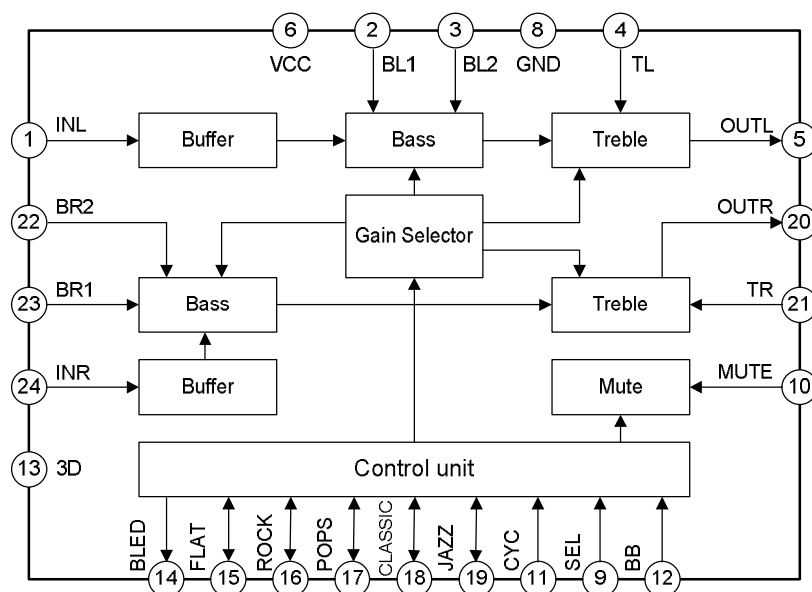

**ABSOLUTE MAXIMUM RATINGS**

Characteristics	Symbol	Rating	Unit
Supply Voltage	VCC	10	V
Operating Temperature	T <sub>opr</sub>	-20 ~ 75	°C
Storage Temperature	T <sub>stg</sub>	-40 ~ 125	°C
Input Voltage	V <sub>IN</sub>	-0.3 ~ VCC+0.3	V

**ELECTRICAL CHARACTERISTICS (Unless otherwise specified, Vcc=9V, Vi=1Vrms, f=1kHz)**

Characteristics	Symbol	Test conditions	Min.	Typ.	Max.	Unit
Supply Voltage	VCC	--	5	9	9.5	V
Supply Current	ICC	VCC = 9V, Vi = 0V, Flat mode	--	25	--	mA
Maximum Output Voltage	VOM	VCC = 9V	2.5	--	--	V <sub>rm</sub>
Output Noise	VNO	VCC = 9V, Vi = 0V BW = 20~20kHz A - Weighting	--	--	-90	dB
Total Harmonic Distortion	THD	VCC = 9V, Vi = 0.2Vrms BW = 20~20kHz	--	--	0.01	%
Input Impedance	RIN	VCC = 9V	--	100	--	kΩ
Output Impedance	ROUT	VCC = 9V	--	40	--	Ω
High Level Input Voltage	VIH	VCC = 9V	--	--	0.7VCC	V
Low Level Input Voltage	VIL	VCC= 9V	0.3VCC	--	--	V
Maximum Input Voltage	VIMAX	VCC = 9V, Flat mode, BB & 3D Off	--	--	2.0	V <sub>rms</sub>

**PIN CONFIGURATION**

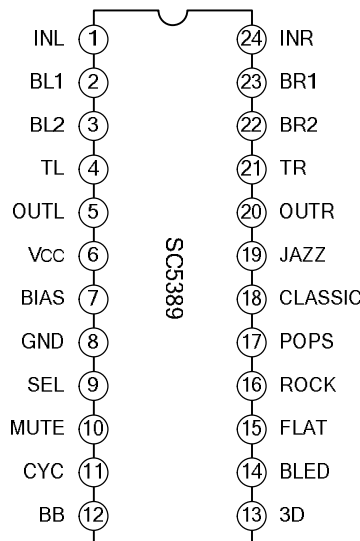

**PIN DESCRIPTION**

Pin No	Symbol	Function
1	INL	Left channel input
2	BL1	Left bass control pin 1. A capacitor may be connected between this pin and BL2.
3	BL2	Left bass control pin 2. A capacitor may be connected between this pin and BL1.
4	TL	Left treble control pin. A capacitor may be connected between this pin and OUTL.
5	OUTL	Left channel output pin
6	Vcc	Positive supply voltage
7	BIAS	A capacitor may be connected between this pin and GND.
8	GND	Ground
9	SEL	Select control pin
10	MUTE	Mute pin. The mute pin can eliminate the noise when mode changing occurs. A capacitor may be connected between this pin and GND.
11	CYC	Cyclic select pin
12	BB	Bass booster control input pin
13	3D	3D effect control input pin / output LED pin
14	BLED	Bass booster display pin
15	FLAT	Flat mode display & control input pin
16	ROCK	Rock mode display & control input pin
17	POPS	Pops mode display & control input pin
18	CLASSIC	Classic mode display & control input pin
19	JAZZ	Jazz mode display & control input pin
20	OUTR	Right channel output pin
21	TR	Right treble control pin A capacitor is connected between this pin and OUTR.
22	BR2	Right bass control pin 2 A capacitor is connected between this pin and BR1
23	BR1	Right bass control pin1 A capacitor is connected between this pin and BR2
24	INR	Right channel input pin

## FUNCTIONAL DESCRIPTION

SC5389 is a 5-Mode Preset Equalizer IC with a Bass Booster and 3D Effects. It has 2 types of key selection mode, namely: Direct and Cyclic. The Direct or Cyclic Key Selection Mode are determined by the SEL pin. Please refer to the table below:

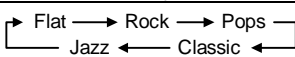
Key Selection Mode	SEL Pin	Description
Direct	Low	Press FLAT key to active Flat Mode
		Press ROCK Key to activate Rock Mode
		Press POPS Key to activate Pops Mode
		Press CLASSIC Key to activate Classic Mode
		Press JAZZ Key to activate Jazz Mode
Cyclic*	Floating / High	

Note: The Bass Booster Function and the 3D Effect can be controlled in the same manner under the Direct or the Cyclic Key Selection Mode. To turn the Bass Booster On or Off, press the BB Key. To turn the 3D Effect On or Off, press the 3D key.

\* = Under the Cyclic Selection Mode, press the CYC key, to go to next sound selection.

### Cyclic Key Selection Mode

As seen in the table above, the Cyclic Key Selection Mode is active when the SEL Pin is Floating or "High". Under this mode, any of the sound selections (Flat, Rock, Pops, Classic, Jazz) may be selected by pressing the CYC Key. The default value is the Flat Mode. This means that when power is turned ON, the Flat mode is active. Pressing the Cyclic Key lets you go from one sound selection to the other in the following order: Flat – Rock – Pops – Classic – Jazz. Please refer to the diagram below.

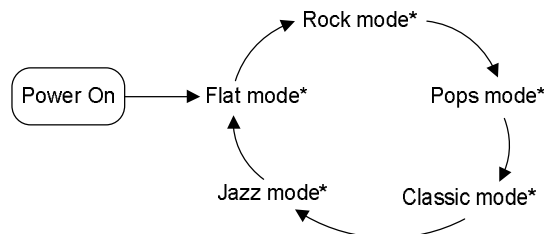

Note: \* Press the CYC Key to activate the next mode  
Press the BB Key to activate the Bass Booster Function  
Press the 3D Key to activate the 3D Effect

The BB Key controls the Bass Booster. When the power is turned ON, the Bass Booster is OFF. Likewise, the 3D Key controls the 3D Effect. When the power is turned ON, the 3D Effect is OFF.

### Direct Key Selection Mode

The Direct Key Selection Mode is active when the SEL Pin is set to "LOW". As the name implies, you can directly select the sound selection you like (Flat, Classic, Rock, Jazz, or Pops) simply by pressing the respective keys. This means, that to select the Jazz mode, press the JAZZ Key, Classic Mode, press the CLASSIC Key and so forth. Take note that when the power is turned ON, the Flat Mode is active. The Bass Booster Function and 3D Effect are independent of the key / sound mode selected and may be turned On or Off at any time.

**FREQUENCY RESPONSE**

The following diagrams illustrate the various frequency response under the various sound selection (Flat, Rock, Pops, Classic, Jazz and Bass Booster, 3D).

*FLAT Mode*

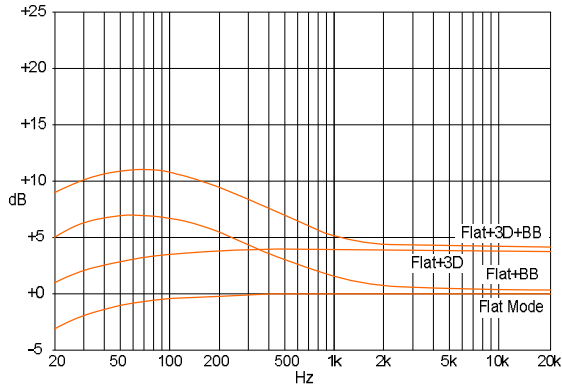

*Rock Mode*

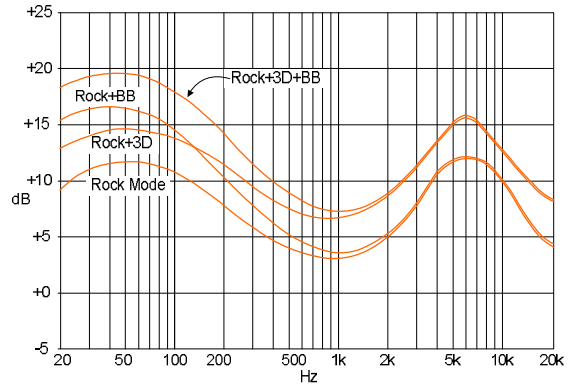

*Pops Mode*

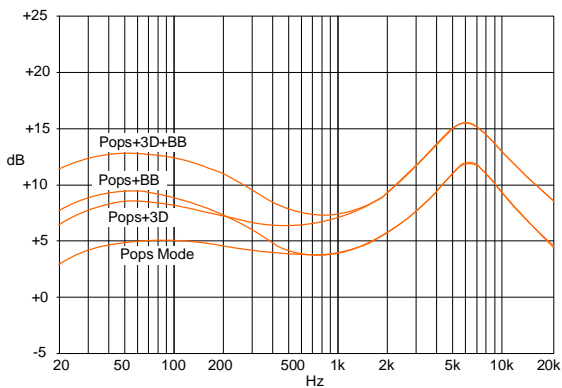

*Classic Mode*

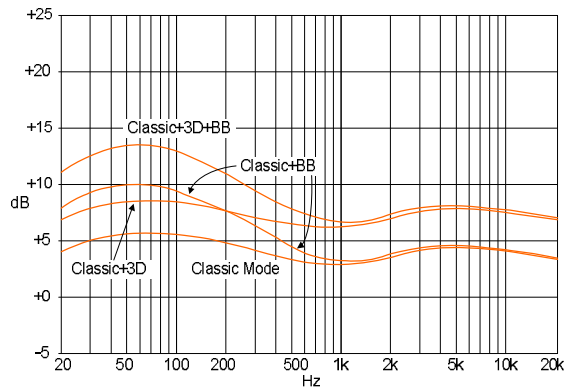

*Jazz Mode*

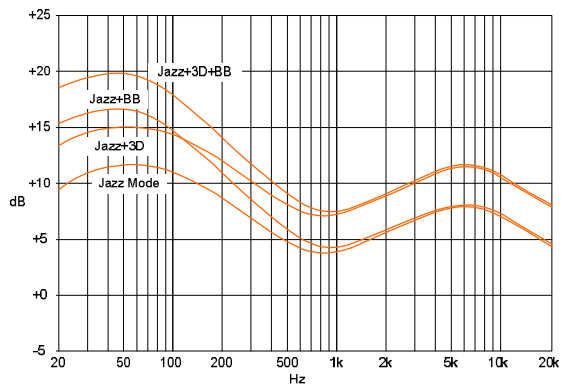

Different sound selections exhibit different frequency gains at different frequency levels. Please refer to the table below:

Sound Selection	Typ.			Unit
	f = 80Hz	f = 1kHz	f = 10kHz	
Flat	3	3	3	dB
Rock	14	6.5	12.5	
Pops	8	6	12.5	
Classic	8.5	7	7.5	
Jazz	14.5	7.5	10.5	
Flat + Bass Booster	10	5	4	
Rock + Bass Booster	18.5	7	12.5	
Pops + Bass Booster	12.5	6.5	12.5	
Classic + Bass Booster	13	7	8	
Jazz + Bass Booster	18.5	7.5	10.5	
Flat + 3D	7	7	7	
Rock + 3D	18	10	16	
Pops + 3D	11.5	9.5	16	
Classic + 3D	12	9.5	11	
Jazz + 3D	18	10.5	14	
Flat + BB + 3D	14	8.5	7.5	
Rock + BB + 3D	22.2	10.5	16.5	
Pops + BB + 3D	16.5	10	16	
Classic + BB + 3D	16.5	10.5	11	
Jazz + BB + 3D	22.5	11	14	

## TREBLE AND BASS ADJUSTMENTS

It is general knowledge that different individuals have different listening preferences. The application circuit of SC5389 included in this specification has been designed for the taste general listening public; however, you can make the necessary adjustment to suit your personal taste. Please refer to the sections below.

### Treble Adjustment

The Treble adjustment is made by changing the value of the 2 capacitors connected between TL and OUTL. Please refer to the diagram below.

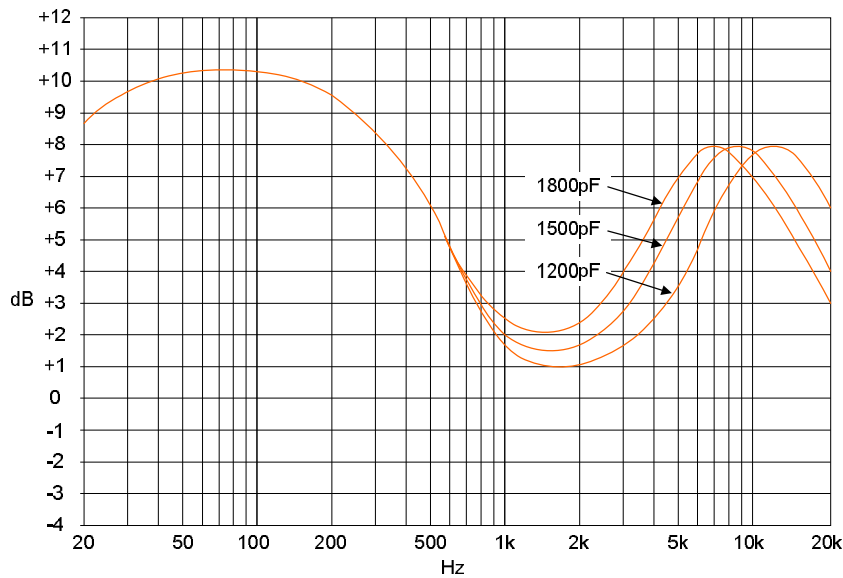

TL-OUTL Capacitors vs. Frequency Response

As the capacitor value becomes bigger, the treble of the gain frequency curve is shifted down. Likewise, as the capacitor value becomes smaller, the treble gain frequency curve shifts the opposite direction. Referring to the diagram above, we see that at 6dB, different capacitor values exhibit different frequency responses. Capacitor value 1800pF has a lower frequency gain response than 1200pF capacitor.

### Bass Adjustment

Bass adjustments can be made by changing the values of the capacitors connected between BL1 – BL2 pins, and BR1 – BR2 pins. The larger the capacitor value used, the frequency response curve shifts down. Likewise, the capacitor value, the frequency response curve shifts the opposite direction. Please refer to the diagram below.

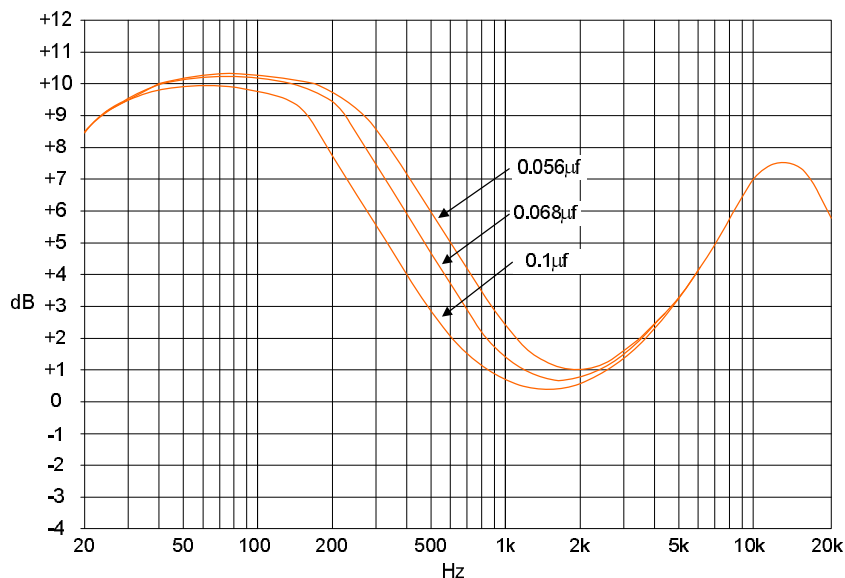

BL1—BL2 Capacitor vs. Frequency Response Curve

In the diagram above, at 9 dB – different capacitor values exhibit different frequency responses. A capacitor with a value of 0.1µf has smaller frequency response than a 0.056µf capacitor.

**APPLICATION CIRCUIT**

**Direct Key Mode**

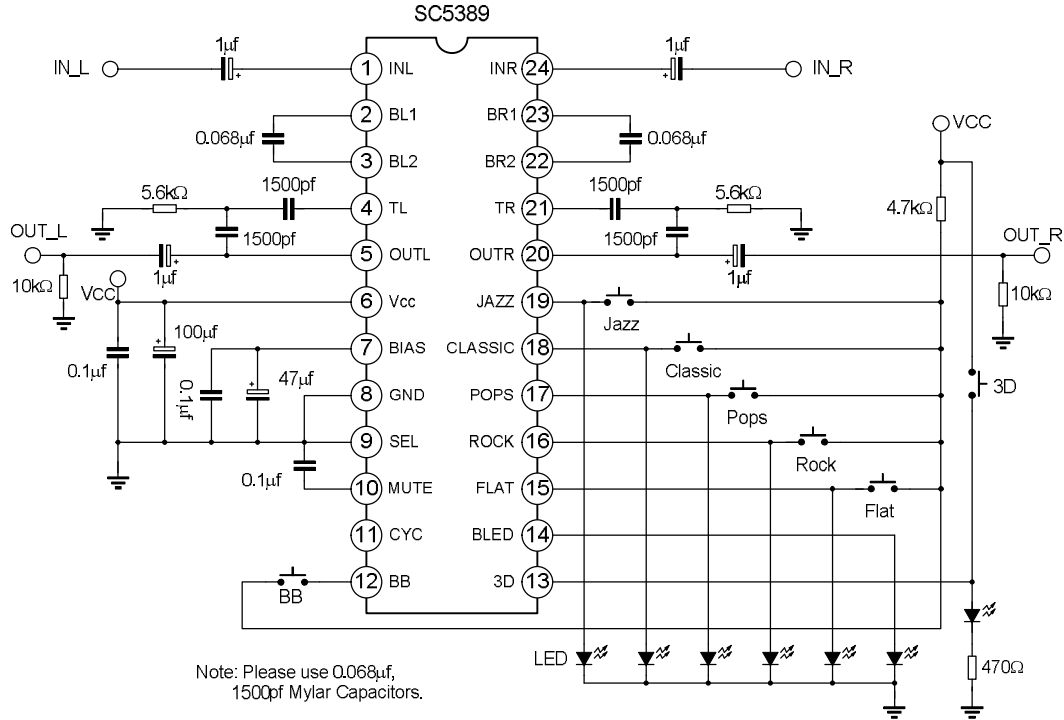

**Cyclic Key Mode**

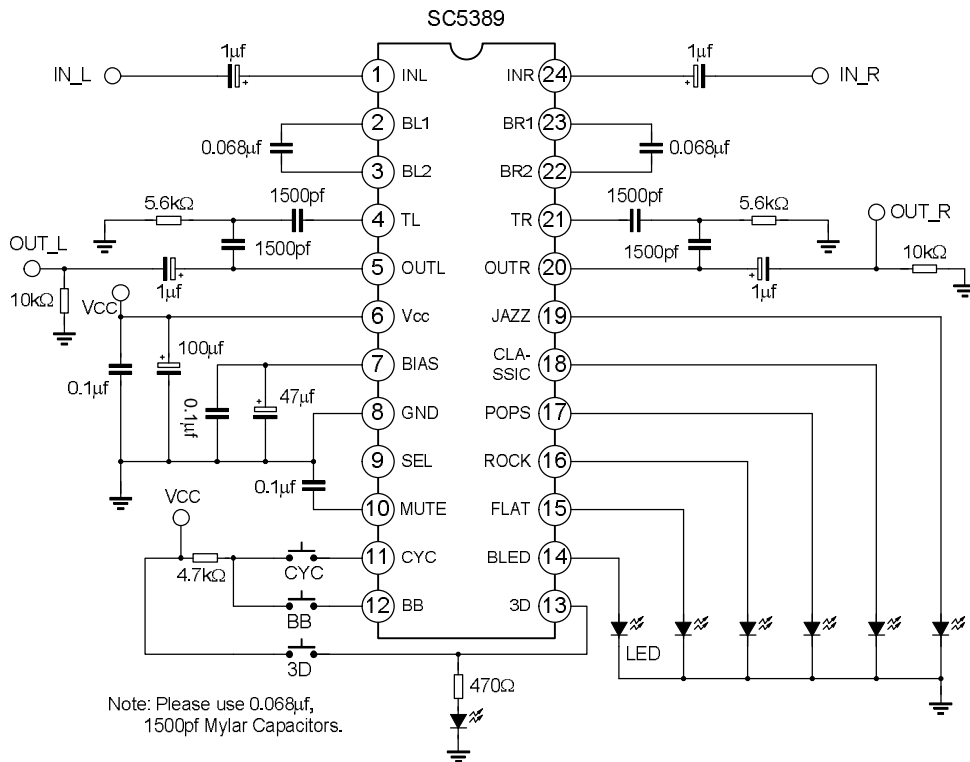

PACKAGE OUTLINE

SDIP-24-300-2.54

UNIT: mm

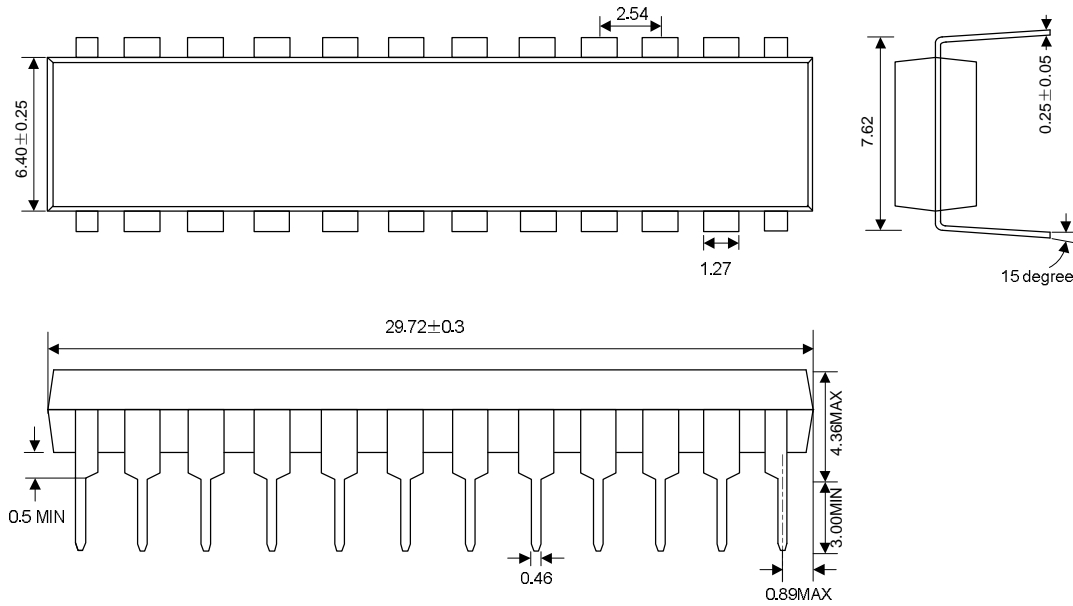

SOP-24-375-1.27

UNIT: mm

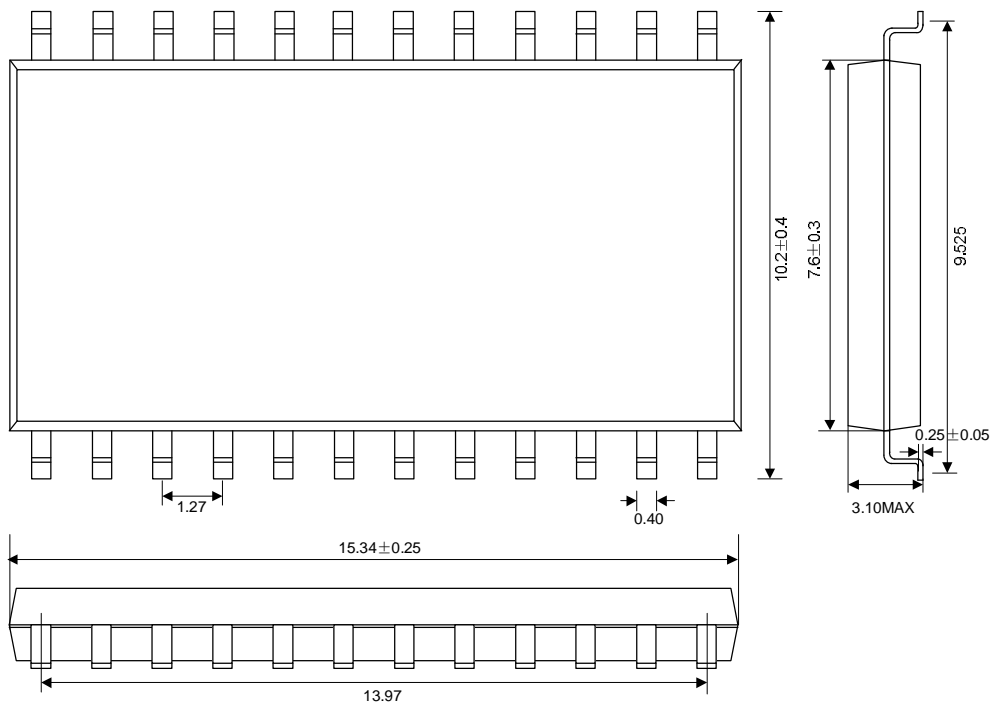



#### **HANDLING MOS DEVICES:**

Electrostatic charges can exist in many things. All of our MOS devices are internally protected against electrostatic discharge but they can be damaged if the following precautions are not taken:

- Persons at a work bench should be earthed via a wrist strap.
- Equipment cases should be earthed.
- All tools used during assembly, including soldering tools and solder baths, must be earthed.
- MOS devices should be packed for dispatch in antistatic/conductive containers.