

25x25x4 Ceramic Patch Antenna (Standard)

1. Explanation of Product Number

H	2	P	1	3	A	A	A	A	B	0	3	0	0
				(1)	(2)	(3)	(4)	(5)	(6)				



Product Code:

- (1) Product Categories:
3: ceramic patch antenna
- (2) Dimensions and Polarization:
AA: 25x25x04 (mm)/right hand circular polarization
- (3) Material:
A: MA-PC
- (4) Working Frequency:
A: 1575.42MHz
- (5) Ground Plane Dimensions:
B: 70x70(mm)
- (6) Antenna Series:
03: serial number

Tolerances (Unless otherwise specified) X : ± 1 X.X : ± 0.1 X.XX : ± 0.01 Angle : ± Hole Dia. : ±		Unictron Technologies Corporation Website: www.unictron.com	
Scale :	Unit : mm	THIS SPECIFICATION IS THE PROPERTY OF UNICTRON TECHNOLOGIES CORPORATION AND SHALL NOT BE REPRODUCED OR USED IN ALL CIRCUMSTANCES WITHOUT WRITTEN PERMISSION. <div style="position: absolute; top: 0; right: 0; border: 1px solid black; border-radius: 50%; padding: 5px; color: blue; font-weight: bold;">2010-08-04</div>	
Prepared By : Meiping	Checked By : Chinling		
Designed By : Chinling	Approved By : Herbert		
TITLE : 25*25*4 Ceramic Patch Antenna (Standard)		DOCUMENT NO.	H2P13AAAAB0300
		REV. E	

2. Features

- *Stable and reliable in performances
- *Low temperature coefficient of frequency
- *Compact size
- *RoHS compliance

3. Applications

- *Navigation systems or position tracking systems
- *Hand-held devices when GPS function is needed, e.g., PDA, Smart phone, PND.

4. Description

Unictron's patch antenna series are ceramic antennas specially designed for GPS application. This ceramic patch antenna has excellent stability and sensitivity through the use of high performance proprietary ceramic materials and processes.

5. Electrical Specifications (70x70(mm) ground plane)

Characteristics		Specifications	Unit
Outline Dimensions		25×25×4	mm
Ground Plane		70×70	mm
Center Frequency*		1581±2	MHz
Bandwidth (under -10dB return loss)		15 min.	MHz
VSWR		1.5 max.	
Impedance		50	Ω
Polarization		RHCP	
Gain	@Zenith	+5 (typical)	dBic
	@10° Elevation	-1 (typical)	
Axial Ratio		3 (typical)	dB
Temperature Coefficient of Frequency		0±20 max (@ -40°C ~80°C)	ppm/°C

*Center frequency will be offset to working frequency according to the conditions of user's ground plane and radome.

Tolerances (Unless otherwise specified)

X : ± 1 X.X : ± 0.1 X.XX : ± 0.01

Angle : ± Hole Dia. : ±



Unictron Technologies Corporation
Website: www.unictron.com

Scale : Unit : mm

Prepared By : Meiping Checked By : Chinling

Designed By : Chinling Approved By : Herbert

THIS SPECIFICATION IS THE PROPERTY OF UNICTRON TECHNOLOGIES CORPORATION AND SHALL NOT BE REPRODUCED OR USED IN ALL CIRCUMSTANCES WITHOUT WRITTEN PERMISSION

2010-08-04

**TITLE : 25*25*4 Ceramic Patch Antenna
(Standard)**

DOCUMENT
NO.

H2P13AAAAB0300

REV.
E

6. Antenna Dimensions (unit: mm)

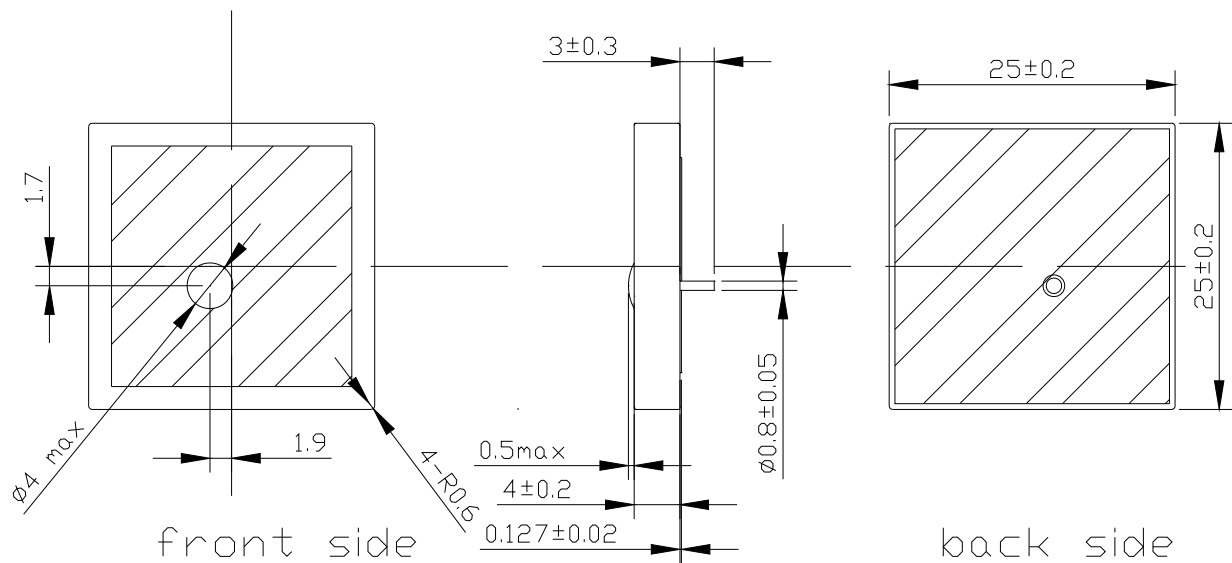

7. Electrical Characteristics (70x70(mm) ground plane)

Return Loss(S_{11})

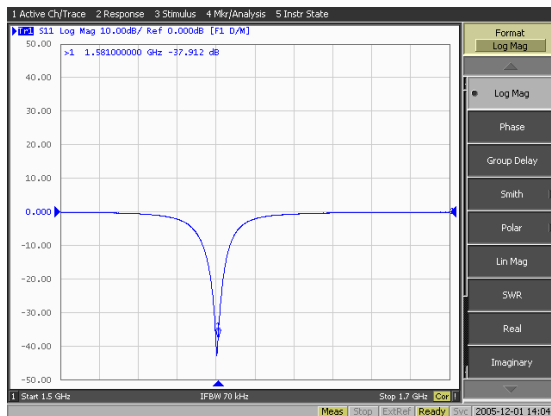

Smith Chart

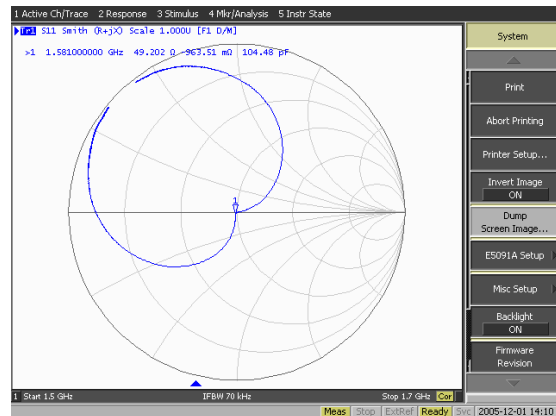

Tolerances (Unless otherwise specified)

X : ± 1 X.X : ± 0.1 X.XX : ± 0.01

Angle : \pm

Hole Dia. : \pm



Unictron Technologies Corporation
Website: www.unictron.com

Scale :

Unit : mm

Prepared By : Meiping

Checked By :
Chinling

Designed By : Chinling

Approved By :
Herbert

THIS SPECIFICATION IS THE PROPERTY OF UNICTRON TECHNOLOGIES CORPORATION AND SHALL NOT BE REPRODUCED OR USED IN ALL CIRCUMSTANCES WITHOUT WRITTEN PERMISSION

2010-08-04

TITLE : 25*25*4 Ceramic Patch Antenna
(Standard)

DOCUMENT
NO.

H2P13AAAAB0300

REV.

E

8. Axial Ratio (70x70(mm) ground plane)

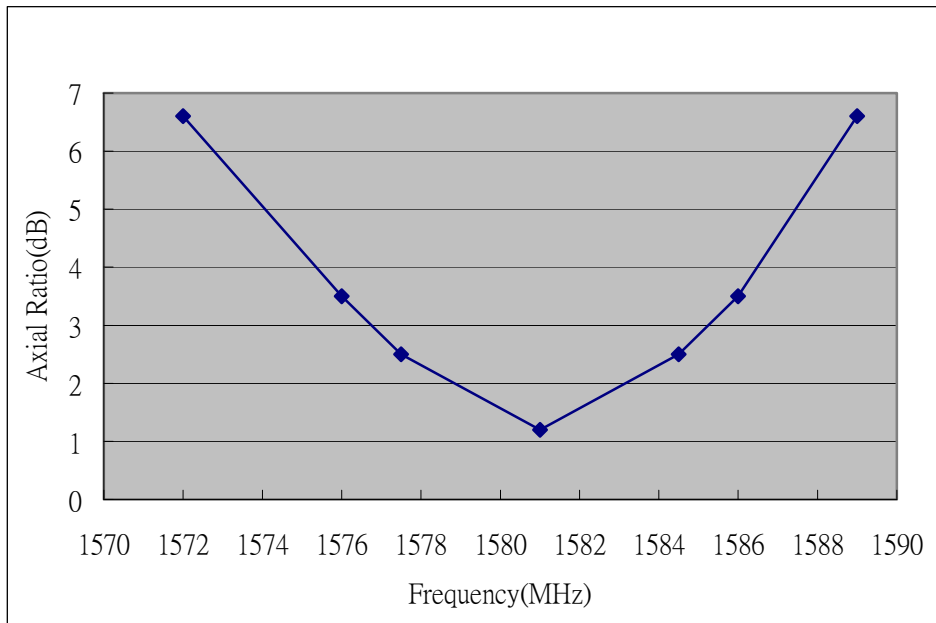

9. Gain vs. Ground Plane Size

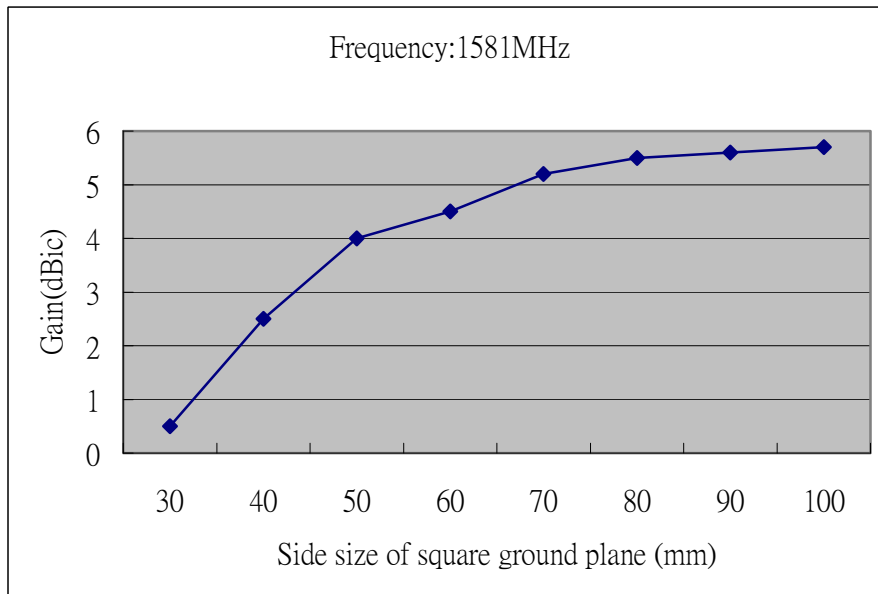

Tolerances (Unless otherwise specified)

X : ± 1 X.X : ± 0.1 X.XX : ± 0.01

Angle : ±

Hole Dia. : ±



Unictron Technologies Corporation
Website: www.unictron.com

Scale :

Unit : mm

Prepared By : Meiping

Checked By :
Chinling

Designed By : Chinling

Approved By :
Herbert

THIS SPECIFICATION IS THE PROPERTY OF UNICTRON TECHNOLOGIES CORPORATION AND SHALL NOT BE REPRODUCED OR USED IN ALL CIRCUMSTANCES WITHOUT WRITTEN PERMISSION

2010-08-04

**TITLE : 25*25*4 Ceramic Patch Antenna
(Standard)**

**DOCUMENT
NO.**

H2P13AAAAB0300

REV.

E

10. Radiation Pattern (70x70(mm) ground plane)

0°

Far-field amplitude of 254 Gain Chart01.nsi

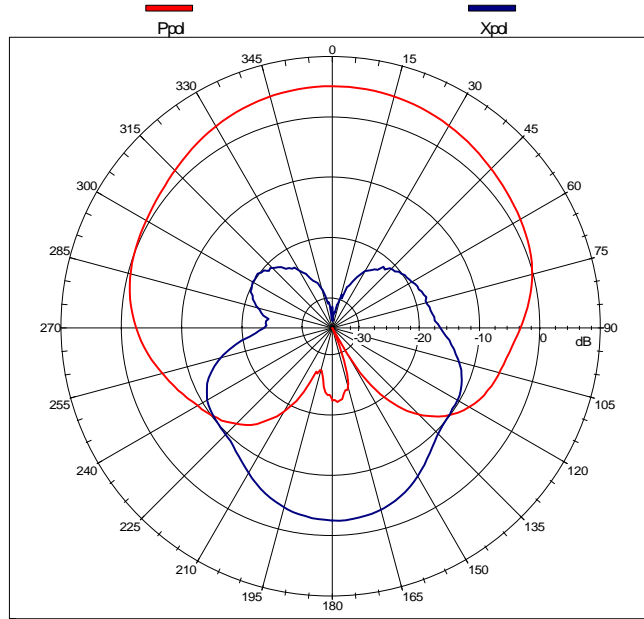

90°

Far-field amplitude of 254 Gain Chart02.nsi

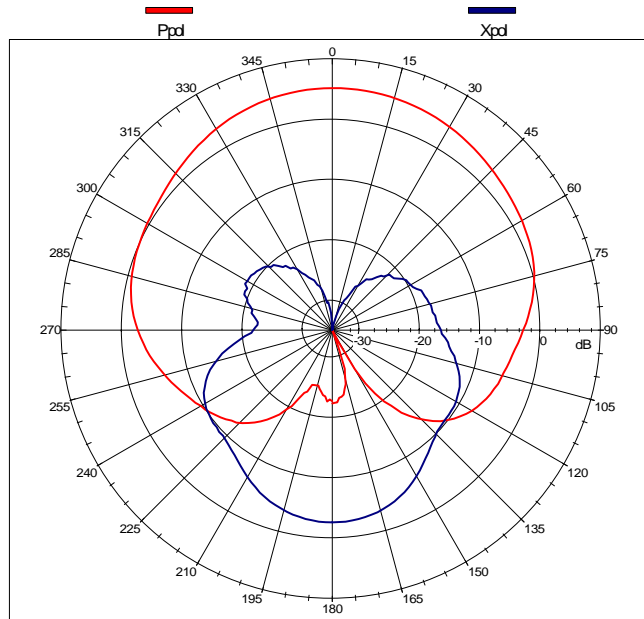

Right hand circular polarized signal $f_0=1581\text{MHz}$

Tolerances (Unless otherwise specified) X : ± 1 X.X : ± 0.1 X.XX : ± 0.01 Angle : ± Hole Dia. : ±		 Unictron Technologies Corporation Website: www.unictron.com	2010-08-04 Document Control Center
Scale :	Unit : mm		
Prepared By : Meiping	Checked By : Chinling	DOCUMENT NO. H2P13AAAAB0300 REV. E	
Designed By : Chinling	Approved By : Herbert		
TITLE : 25*25*4 Ceramic Patch Antenna (Standard)		DOCUMENT NO. H2P13AAAAB0300 REV. E	REV. E