

EVALUATION KIT
AVAILABLE**MAXIM**

2.3W, Ultra-Low-EMI, Filterless, Class D Audio Amplifier

MAX9705

General Description

The MAX9705 3rd-generation, ultra-low EMI, mono, Class D audio power amplifier provides Class AB performance with Class D efficiency. The MAX9705 delivers 2.3W into a 4Ω load and offers efficiencies above 85%. Active emissions limiting (AEL) circuitry greatly reduces EMI by actively controlling the output FET gate transitions under all possible transient output-voltage conditions. AEL prevents high-frequency emissions resulting from conventional Class D free-wheeling behavior in the presence of an inductive load. Zero dead time (ZDT) technology maintains state-of-the-art efficiency and THD+N performance by allowing the output FETs to switch simultaneously without cross-conduction. A patented spread-spectrum modulation scheme eliminates the need for output filtering found in traditional Class D devices. These design concepts reduce an application's component count and extend battery life.

The MAX9705 offers two modulation schemes: a fixed-frequency (FFM) mode and a spread-spectrum (SSM) mode that further reduces EMI-radiated emissions due to the modulation frequency. The MAX9705 oscillator can be synchronized to an external clock through the SYNC input, allowing the switching frequency to be externally defined. The SYNC input also allows multiple MAX9705s to be cascaded and frequency locked, minimizing interference due to clock intermodulation. The device utilizes a fully differential architecture, a full-bridged output, and comprehensive click-and-pop suppression. The gain of the MAX9705 is set internally (MAX9705A: 6dB, MAX9705B: 12dB, MAX9705C: 15.6dB, MAX9705D: 20dB), further reducing external component count.

The MAX9705 is available in 10-pin TDFN (3mm x 3mm x 0.8mm), 10-pin μMAX®, and 12-bump UCSP™ (1.5mm x 2mm x 0.6mm) packages. The MAX9705 is specified over the extended -40°C to +85°C temperature range.

Applications

Cellular Phones
PDAsMP3 Players
Portable Audio

Selector Guide appears at end of data sheet.

μMAX is a registered trademark and UCSP is a trademark of Maxim Integrated Products, Inc.

Features

- ◆ Filterless Amplifier Passes FCC-Radiated Emissions Standards with 24in of Cable
- ◆ Unique Spread-Spectrum Mode and Active Emissions Limiting (AEL) Achieves Better than 20dB Margin Under FCC Limits
- ◆ Zero Dead Time (ZDT) H-Bridge Maintains State-of-the-Art Efficiency and THD+N
- ◆ Simple Master-Slave Setup for Stereo Operation
- ◆ Up to 90% Efficiency
- ◆ 2.3W into 4Ω (1% THD+N)
- ◆ Low 0.02% THD+N (P_{OUT} = 1W, V_{DD} = 5.0V)
- ◆ High PSRR (75dB at 217Hz)
- ◆ Integrated Click-and-Pop Suppression
- ◆ Low Quiescent Current (5.4mA)
- ◆ Low-Power Shutdown Mode (0.3μA)
- ◆ Short-Circuit and Thermal-Overload Protection
- ◆ Available in Thermally Efficient, Space-Saving Packages
 - 10-Pin TDFN (3mm x 3mm x 0.8mm)
 - 10-Pin μMAX
 - 12-Bump UCSP (1.5mm x 2mm x 0.6mm)
- ◆ Pin-for-Pin Compatible with the MAX9700 and MAX9712

Ordering Information

PART	TEMP RANGE	PIN-PACKAGE	TOP MARK
MAX9705AETB+T	-40°C to +85°C	10 TDFN-10	ACY
MAX9705AEUB+	-40°C to +85°C	10 μMAX	—
MAX9705AEBC+T	-40°C to +85°C	12 UCSP-12	ACH
MAX9705BETB+T	-40°C to +85°C	10 TDFN-10	ACX
MAX9705BEUB+	-40°C to +85°C	10 μMAX	—
MAX9705BEBC+T	-40°C to +85°C	12 UCSP-12	ACG

Ordering Information continued at end of data sheet.

+Denotes lead-free package.

EMI Spectrum Diagram

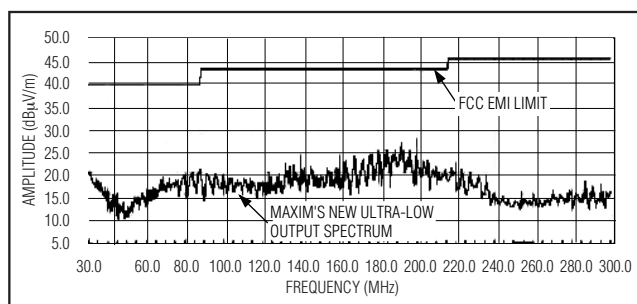
**MAXIM**

Maxim Integrated Products 1

For pricing, delivery, and ordering information, please contact Maxim/Dallas Direct! at 1-888-629-4642, or visit Maxim's website at www.maxim-ic.com.

2.3W, Ultra-Low-EMI, Filterless, Class D Audio Amplifier

ABSOLUTE MAXIMUM RATINGS

V _{DD} to GND6V
PV _{DD} to PGND6V
GND to PGND-0.3V to +0.3V
PV _{DD} to V _{DD}-0.3V to +0.3V
All Other Pins to GND-0.3V to (V _{DD} + 0.3V)
Continuous Current Into/Out of PV _{DD} /PGND/OUT±600mA
Continuous Input Current (all other pins)±20mA
Duration of OUT_ Short Circuit to GND or PV _{DD}Continuous
Duration of Short Circuit Between OUT+ and OUT-Continuous

Continuous Power Dissipation (T _A = +70°C)	
10-Pin TDFN (derate 24.4mW/°C above +70°C)1951.2mW
10-Pin μMAX (derate 5.6mW/°C above +70°C)444.4mW
12-Bump UCSP (derate 6.1mW/°C above +70°C)484mW
Junction Temperature+150°C
Operating Temperature Range-40°C to +85°C
Storage Temperature Range-65°C to +150°C
Lead Temperature (soldering, 10s)+300°C
Bump Temperature (soldering)	
Reflow+235°C

Stresses beyond those listed under "Absolute Maximum Ratings" may cause permanent damage to the device. These are stress ratings only, and functional operation of the device at these or any other conditions beyond those indicated in the operational sections of the specifications is not implied. Exposure to absolute maximum rating conditions for extended periods may affect device reliability.

ELECTRICAL CHARACTERISTICS

(V_{DD} = PV_{DD} = SHDN = 3.3V, GND = PGND = 0V, SYNC = GND (FFM), R_L = ∞, R_L connected between OUT+ and OUT-, T_A = T_{MIN} to T_{MAX}, unless otherwise noted. Typical values are at T_A = +25°C.) (Notes 1, 2)

PARAMETER	SYMBOL	CONDITIONS	MIN	TYP	MAX	UNITS	
GENERAL							
Supply Voltage Range	V _{DD}	Inferred from PSRR test	2.5		5.5	V	
Quiescent Current	I _{DD}			5.4	7	mA	
Shutdown Current	I _{SHDN}			0.3	10	μA	
Turn-On Time	t _{ON}			30		ms	
Input Resistance	R _{IN}	T _A = +25°C	12	20		kΩ	
Input Bias Voltage	V _{BIAS}	Either input	MAX9705A	0.88	1.0	1.12	V
			MAX9705B	0.73	0.83	0.93	
			MAX9705C	0.61	0.71	0.81	
			MAX9705D	0.48	0.56	0.64	
Voltage Gain	A _v	MAX9705A	1.9	2.0	2.1	V/V	
		MAX9705B	3.8	4.0	4.2		
		MAX9705C	5.7	6.0	6.3		
		MAX9705D	9.5	10	10.5		
Output Offset Voltage	V _{OS}	T _A = +25°C		±10	±69	mV	
Common-Mode Rejection Ratio	CMRR	f _{IN} = 1kHz, input referred		56		dB	
Power-Supply Rejection Ratio (Note 3)	PSRR	V _{DD} = 2.5V to 5.5V, T _A = +25°C	50	75		dB	
		200mV _{P-P} ripple	f _{RIPPLE} = 217Hz	75			
				f _{RIPPLE} = 20kHz	60		
Output Power	P _{OUT}	THD+N = 1%, f _{IN} = 1kHz	R _L = 8Ω	600		mW	
			R _L = 4Ω MAX9705_ETB+T and MAX9705_EUB+ only	950			
Total Harmonic Distortion Plus Noise	THD+N	f _{IN} = 1kHz, either FFM or SSM	R _L = 8Ω, P _{OUT} = 450mW	0.02		%	
			R _L = 4Ω, P _{OUT} = 375mW	0.025			
Click/Pop Level	K _{CP}	Peak voltage, A-weighted (Notes 3, 4)	Into shutdown	-68		dB	
			Out of shutdown	-60.5			
Output Slew Rate	SR			176		V/μs	

2.3W, Ultra-Low-EMI, Filterless, Class D Audio Amplifier

MAX9705

ELECTRICAL CHARACTERISTICS (continued)

($V_{DD} = PV_{DD} = \overline{SHDN} = 3.3V$, $GND = PGND = 0V$, $SYNC = GND$ (FFM), $R_L = \infty$, R_L connected between $OUT+$ and $OUT-$, $T_A = T_{MIN}$ to T_{MAX} , unless otherwise noted. Typical values are at $T_A = +25^\circ C$.) (Notes 1, 2)

PARAMETER	SYMBOL	CONDITIONS		MIN	TYP	MAX	UNITS
Rise/Fall Time	t_{RISE} , t_{FALL}	10% to 90%		15			ns
Signal-to-Noise Ratio	SNR	$V_{OUT} = 2V_{RMS}$	BW = 22Hz to 22kHz	FFM	91		dB
				SSM	89		
			A-weighted	FFM	93		
				SSM	91		
Oscillator Frequency	f_{OSC}	SYNC = GND		980	1100	1220	kHz
		SYNC = float		1250	1450	1650	
		SYNC = V_{DD} (SSM mode)		1220 ± 120			
SYNC Frequency Lock Range				800	2000		kHz
Efficiency	η	$P_{OUT} = 800mW$, $f_{IN} = 1kHz$, $R_L = 8\Omega$		89			%
DIGITAL INPUTS (\overline{SHDN}, SYNC)							
Input Thresholds		V_{IH}		2			V
		V_{IL}		0.8			
\overline{SHDN} Input Leakage Current				0.1	± 10		μA
SYNC Input Current		(Note 5)		-1.25	± 10		μA

ELECTRICAL CHARACTERISTICS

($V_{DD} = PV_{DD} = \overline{SHDN} = 5V$, $GND = PGND = 0V$, $SYNC = GND$ (FFM), $R_L = \infty$, R_L connected between $OUT+$ and $OUT-$, $T_A = T_{MIN}$ to T_{MAX} , unless otherwise noted. Typical values are at $T_A = +25^\circ C$.) (Notes 1, 2)

PARAMETER	SYMBOL	CONDITIONS		MIN	TYP	MAX	UNITS
Quiescent Current	I_{DD}			7			mA
Shutdown Current	I_{SHDN}			0.55			μA
Power-Supply Rejection Ratio	PSRR	200mV _{P-P} ripple	$f = 217Hz$	75			dB
			$f = 20kHz$	60			
Output Power	P_{OUT}	THD+N = 1%, $f = 1kHz$	$R_L = 16\Omega$	750		mW	
			$R_L = 8\Omega$	1400			
			$R_L = 4\Omega$	2300			
			MAX9705_ETB+T and MAX9705_EUB+ only				
Total Harmonic Distortion Plus Noise	THD+N	$f = 1kHz$, either FFM or SSM	$R_L = 8\Omega$, $P_{OUT} = 1.0W$	0.02			%
			$R_L = 4\Omega$, $P_{OUT} = 1.75W$	0.05			
Signal-to-Noise Ratio	SNR	$V_{OUT} = 3V_{RMS}$	BW = 22Hz to 22kHz	FFM	94		dB
				SSM	91		
			A-weighted	FFM	97		
				SSM	93		

Note 1: All devices are 100% production tested at $+25^\circ C$. All temperature limits are guaranteed by design.

Note 2: Testing performed with a resistive load in series with an inductor to simulate an actual speaker load. For $R_L = 4\Omega$, $L = 33\mu H$. For $R_L = 8\Omega$, $L = 68\mu H$. For $R_L = 16\Omega$, $L = 136\mu H$.

Note 3: Inputs AC-coupled to GND.

Note 4: Testing performed with 8Ω resistive load in series with $68\mu H$ inductive load connected across BTL output. Mode transitions are controlled by \overline{SHDN} pin. K_{CP} level is calculated as $20 \times \log[(\text{peak voltage under normal operation at rated power level})/(\text{peak voltage during mode transition, no input signal})]$. Units are expressed in dB.

Note 5: SYNC has a $1M\Omega$ resistor to $V_{REF} = 1.25V$.

2.3W, Ultra-Low-EMI, Filterless, Class D Audio Amplifier

Typical Operating Characteristics

($V_{DD} = 3.3V$, $SYNC = V_{DD}$ (SSM), differential input, $T_A = +25^\circ C$, unless otherwise noted. Typical Operating Characteristics for 4Ω load condition apply to the MAX9705_ETB+T and MAX9705_EUB+ only.)

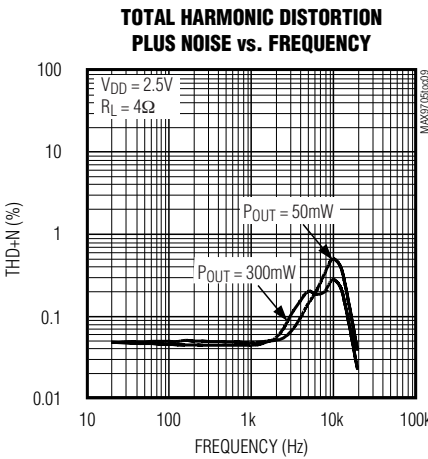
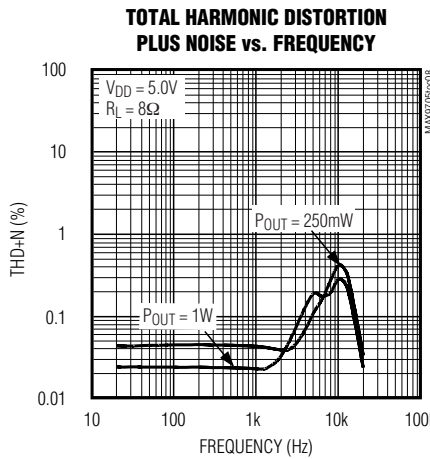
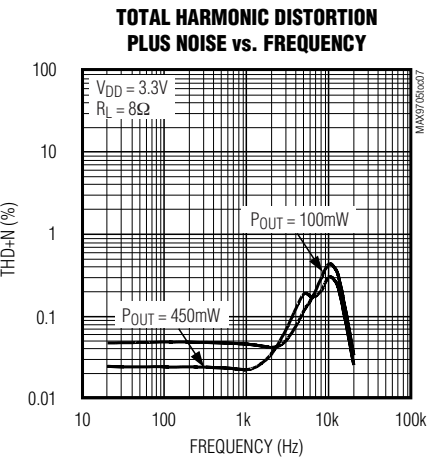
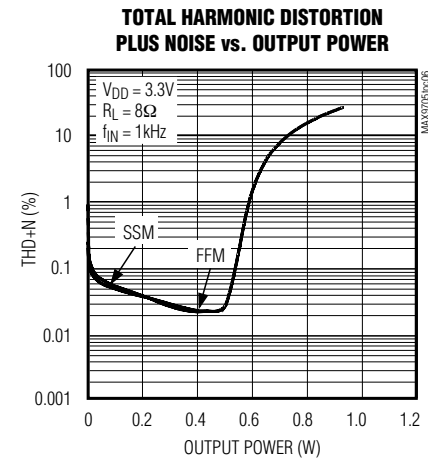
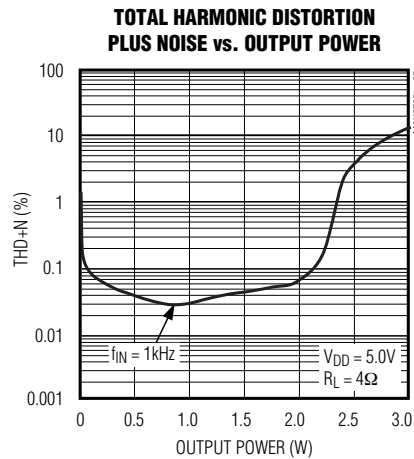
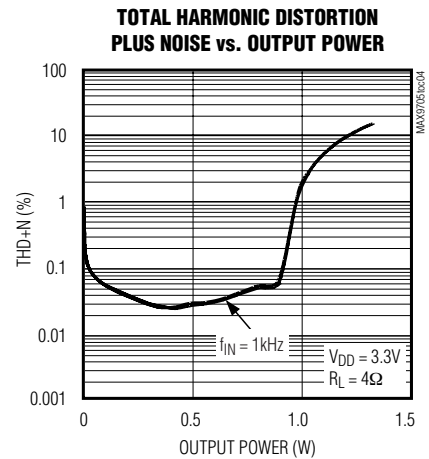
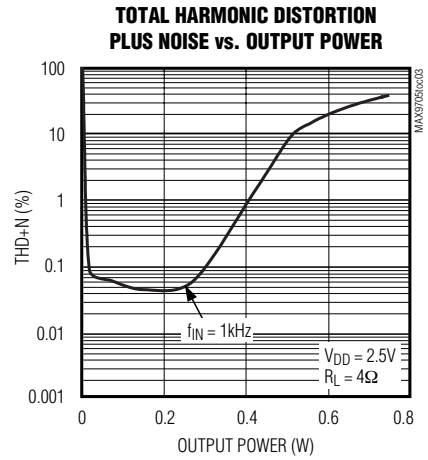
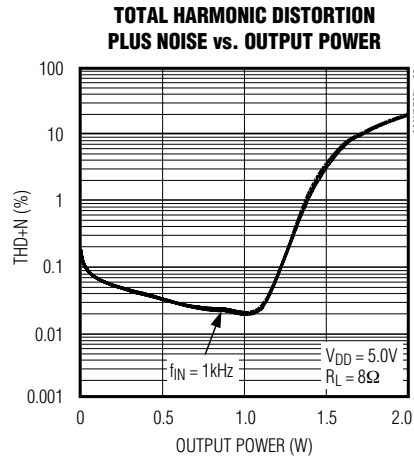
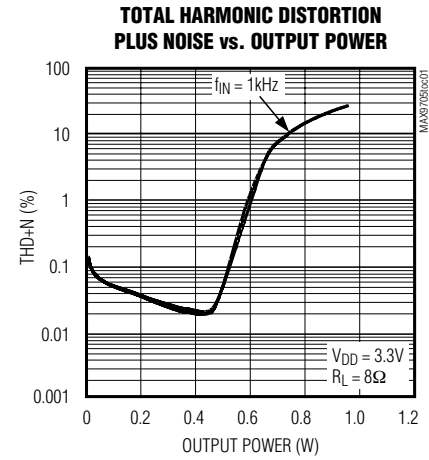

2.3W, Ultra-Low-EMI, Filterless, Class D Audio Amplifier

MAX9705

Typical Operating Characteristics (continued)

($V_{DD} = 3.3V$, SYNC = V_{DD} (SSM), differential input, $T_A = +25^\circ C$, unless otherwise noted. Typical Operating Characteristics for 4Ω load condition apply to the MAX9705_ETB+T and MAX9705_EUB+ only.)

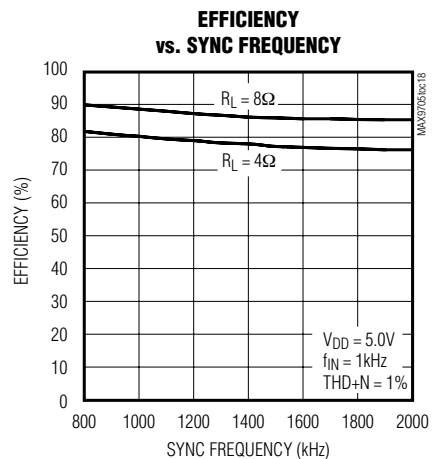
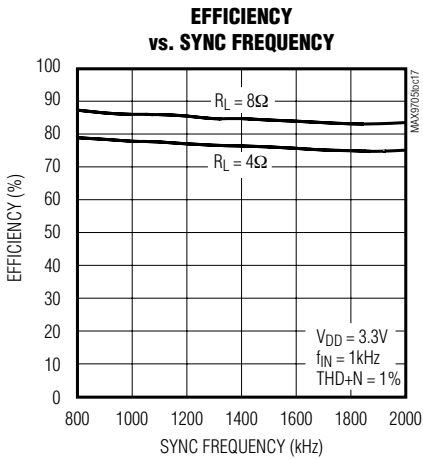
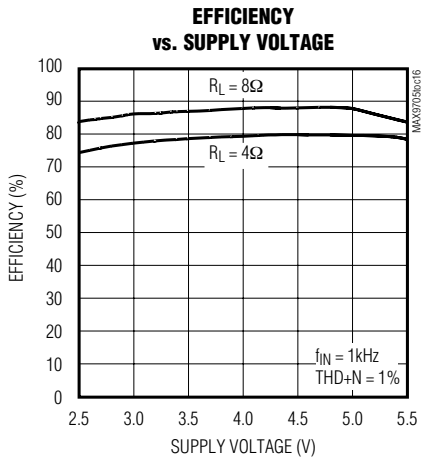
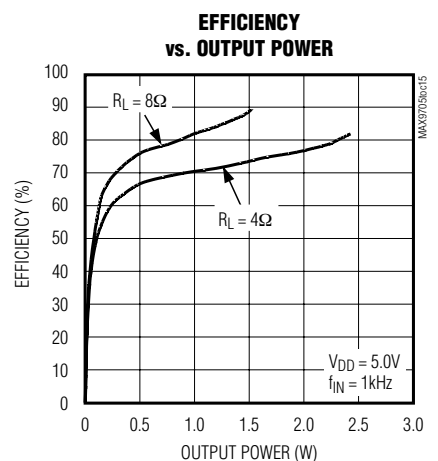
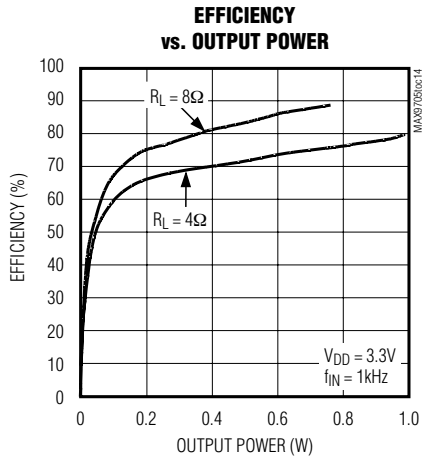
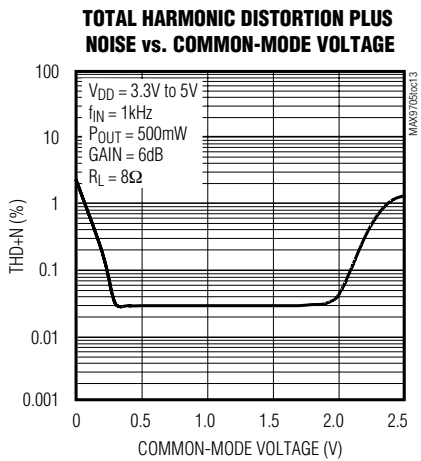
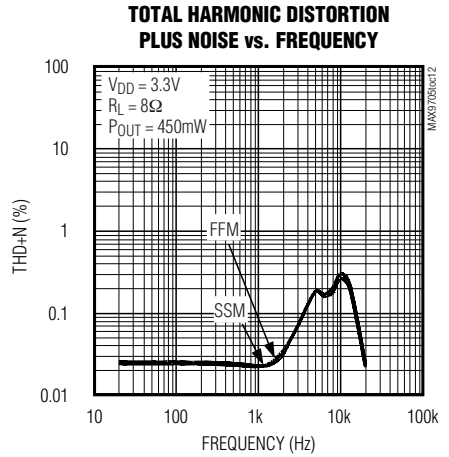
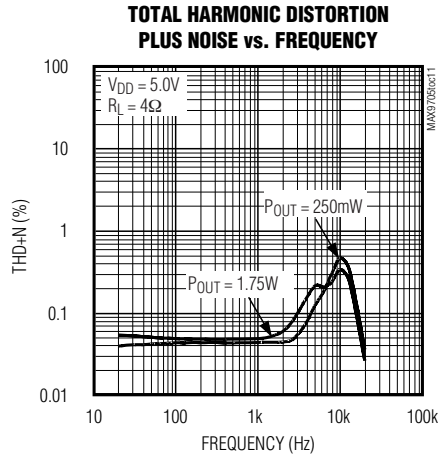
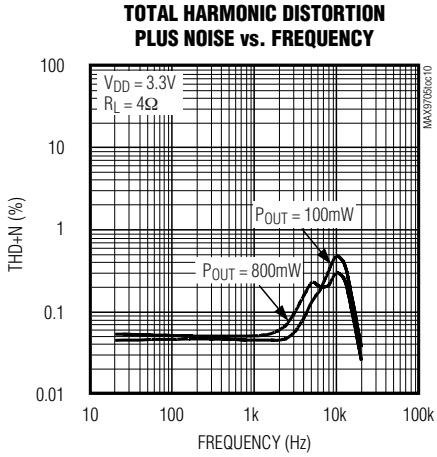

2.3W, Ultra-Low-EMI, Filterless, Class D Audio Amplifier

Typical Operating Characteristics (continued)

($V_{DD} = 3.3V$, SYNC = V_{DD} (SSM), differential input, $T_A = +25^\circ C$, unless otherwise noted. Typical Operating Characteristics for 4Ω load condition apply to the MAX9705_ETB+T and MAX9705_EUB+ only.)

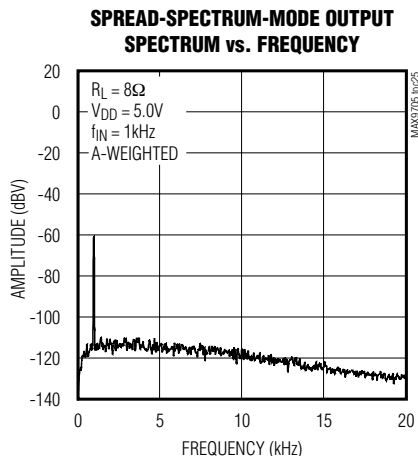
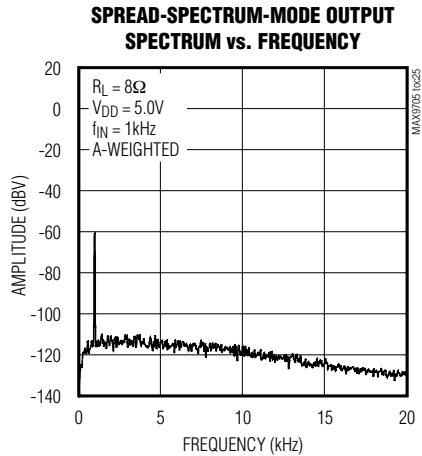
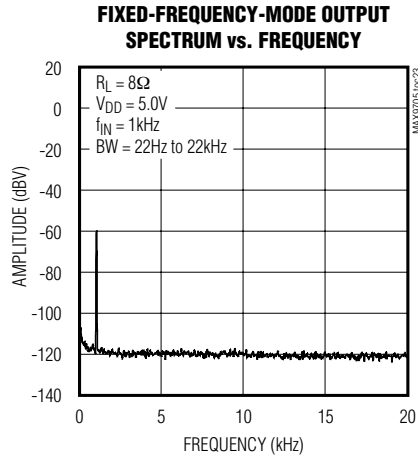
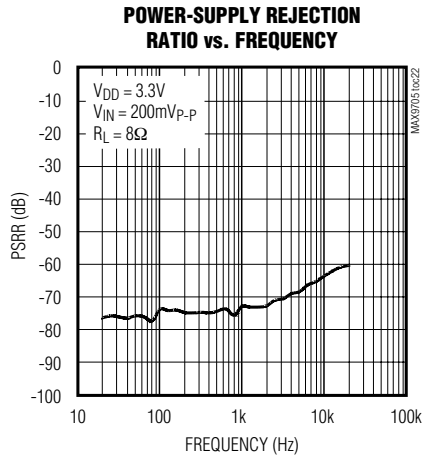
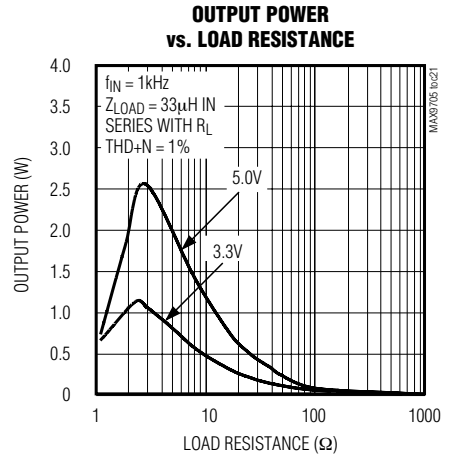
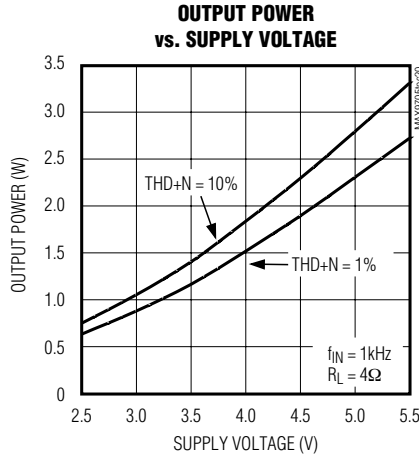
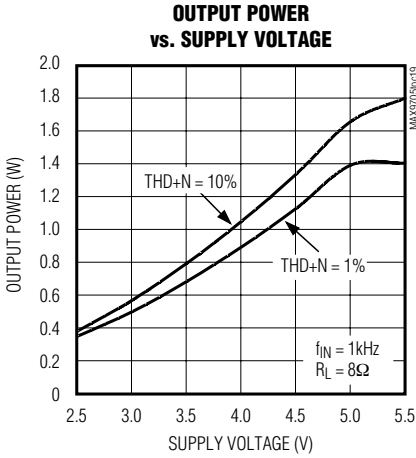

2.3W, Ultra-Low-EMI, Filterless, Class D Audio Amplifier

MAX9705

Typical Operating Characteristics (continued)

($V_{DD} = 3.3V$, SYNC = V_{DD} (SSM), differential input, $T_A = +25^\circ C$, unless otherwise noted. Typical Operating Characteristics for 4 Ω load condition apply to the MAX9705_ETB+T and MAX9705_EUB+ only.)

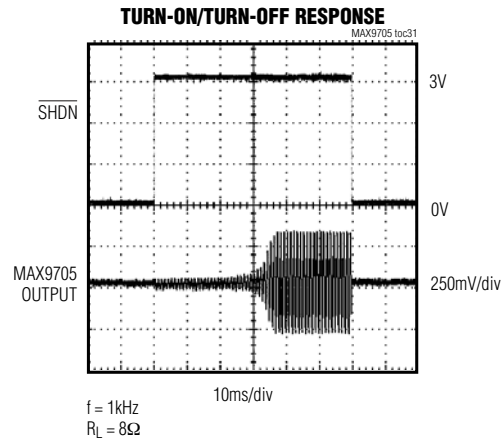
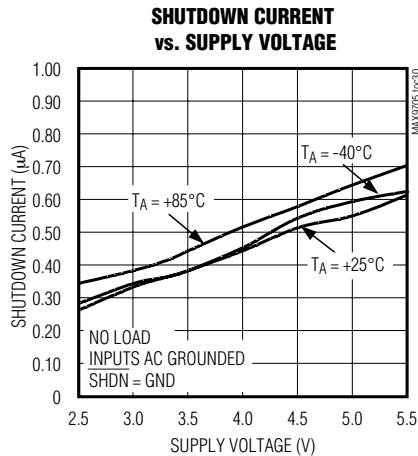
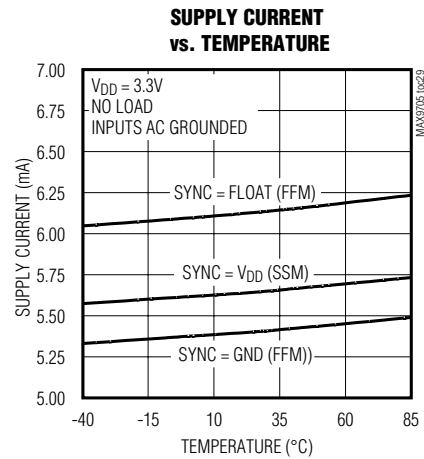
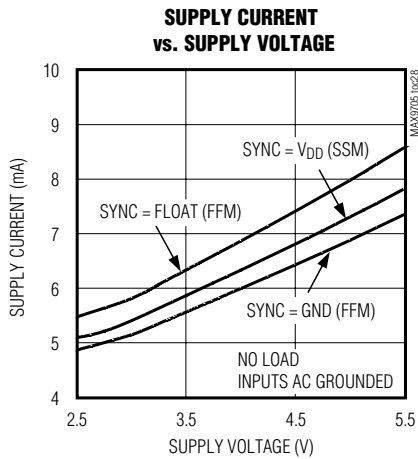
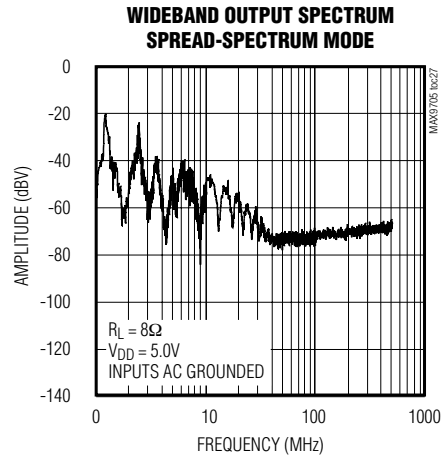
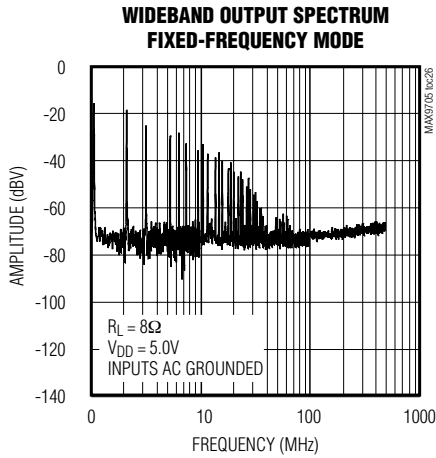

2.3W, Ultra-Low-EMI, Filterless, Class D Audio Amplifier

Functional Diagram

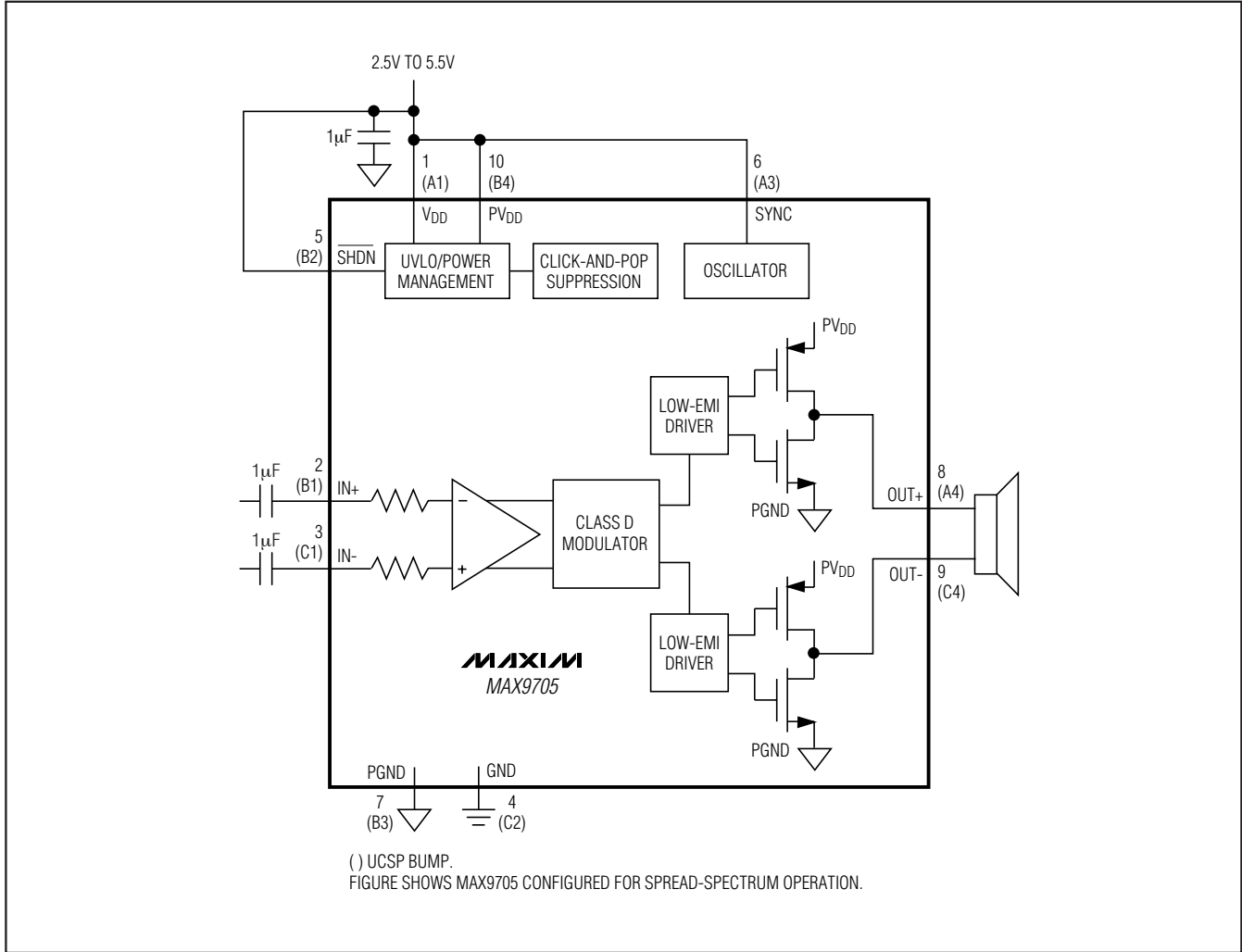

2.3W, Ultra-Low-EMI, Filterless, Class D Audio Amplifier

Pin Description

MAX9705

PIN	BUMP	NAME	FUNCTION
TDFN/ μ MAX	UCSP		
1	A1	V _{DD}	Analog Power Supply
2	B1	IN+	Noninverting Audio Input
3	C1	IN-	Inverting Audio Input
4	C2	GND	Analog Ground
5	B2	$\overline{\text{SHDN}}$	Active-Low Shutdown Input. Connect to V _{DD} for normal operation.
6	A3	SYNC	Frequency Select and External Clock Input. SYNC = GND: Fixed-frequency mode with $f_S = 1100\text{kHz}$. SYNC = Float: Fixed-frequency mode with $f_S = 1450\text{kHz}$. SYNC = V_{DD}: Spread-spectrum mode with $f_S = 1220\text{kHz} \pm 120\text{kHz}$. SYNC = Clocked: Fixed-frequency mode with $f_S = \text{external clock frequency}$.
7	B3	PGND	Power Ground
8	A4	OUT+	Amplifier-Output Positive Phase
9	C4	OUT-	Amplifier-Output Negative Phase
10	B4	PV _{DD}	H-Bridge Power Supply

Detailed Description

The MAX9705 ultra-low-EMI, filterless, Class D audio power amplifier features several improvements to switch-mode amplifier technology. The MAX9705 features output driver active emissions limiting circuitry to reduce EMI. Zero dead time technology maintains state-of-the-art efficiency and THD+N performance by allowing the output FETs to switch simultaneously without cross-conduction. A unique filterless modulation scheme, synchronizable switching frequency, and spread-spectrum mode create a compact, flexible, low-noise, efficient audio power amplifier while occupying minimal board space. The differential input architecture reduces common-mode noise pickup with or without the use of input-coupling capacitors. The MAX9705 can also be configured as a single-ended input amplifier without performance degradation.

Thermal-overload and short-circuit protection prevent the MAX9705 from being damaged during a fault condition. The amplifier is disabled if the die temperature reaches +125°C. The die must cool by 10°C before normal operation can continue. The output of the MAX9705 shuts down if the output current reaches approximately 2A. Each output FET has its own short-circuit protection. This protection scheme allows the amplifier to survive shorts to either supply rail. After a thermal overload or short circuit, the device remains disabled for a minimum of 50 μ s before attempting to return to normal operation. The amplifier will shut down immediately and wait another 50 μ s before turning on if the fault condition is still present. This operation will cause the output to pulse during a persistent fault.

Comparators monitor the MAX9705 inputs and compare the complementary input voltages to the sawtooth waveform. The comparators trip when the input magnitude of the sawtooth exceeds their corresponding input voltage. Both comparators reset at a fixed time after the rising edge of the second comparator trip point, generating a minimum-width pulse $t_{\text{ON(MIN)}}$ at the output of the second comparator (Figure 1). As the input voltage increases or decreases, the duration of the pulse at one output increases (the first comparator to trip), while the other output pulse duration remains at $t_{\text{ON(MIN)}}$. This causes the net voltage across the speaker (V_{OUT+} - V_{OUT-}) to change.

Operating Modes

Fixed-Frequency Modulation (FFM) Mode

The MAX9705 features two FFM modes. The FFM modes are selected by setting SYNC = GND for a 1.1MHz switching frequency, and SYNC = FLOAT for a 1.45MHz switching frequency. In FFM mode, the frequency spectrum of the Class D output consists of the fundamental switching frequency and its associated harmonics (see the Wideband FFT graph in the *Typical Operating Characteristics*). The MAX9705 allows the switching frequency to be changed by +32%, should the frequency of one or more of the harmonics fall in a sensitive band. This can be done at any time and does not affect audio reproduction.

Spread-Spectrum Modulation (SSM) Mode

The MAX9705 features a unique, patented spread-spectrum mode that flattens the wideband spectral components,

2.3W, Ultra-Low-EMI, Filterless, Class D Audio Amplifier

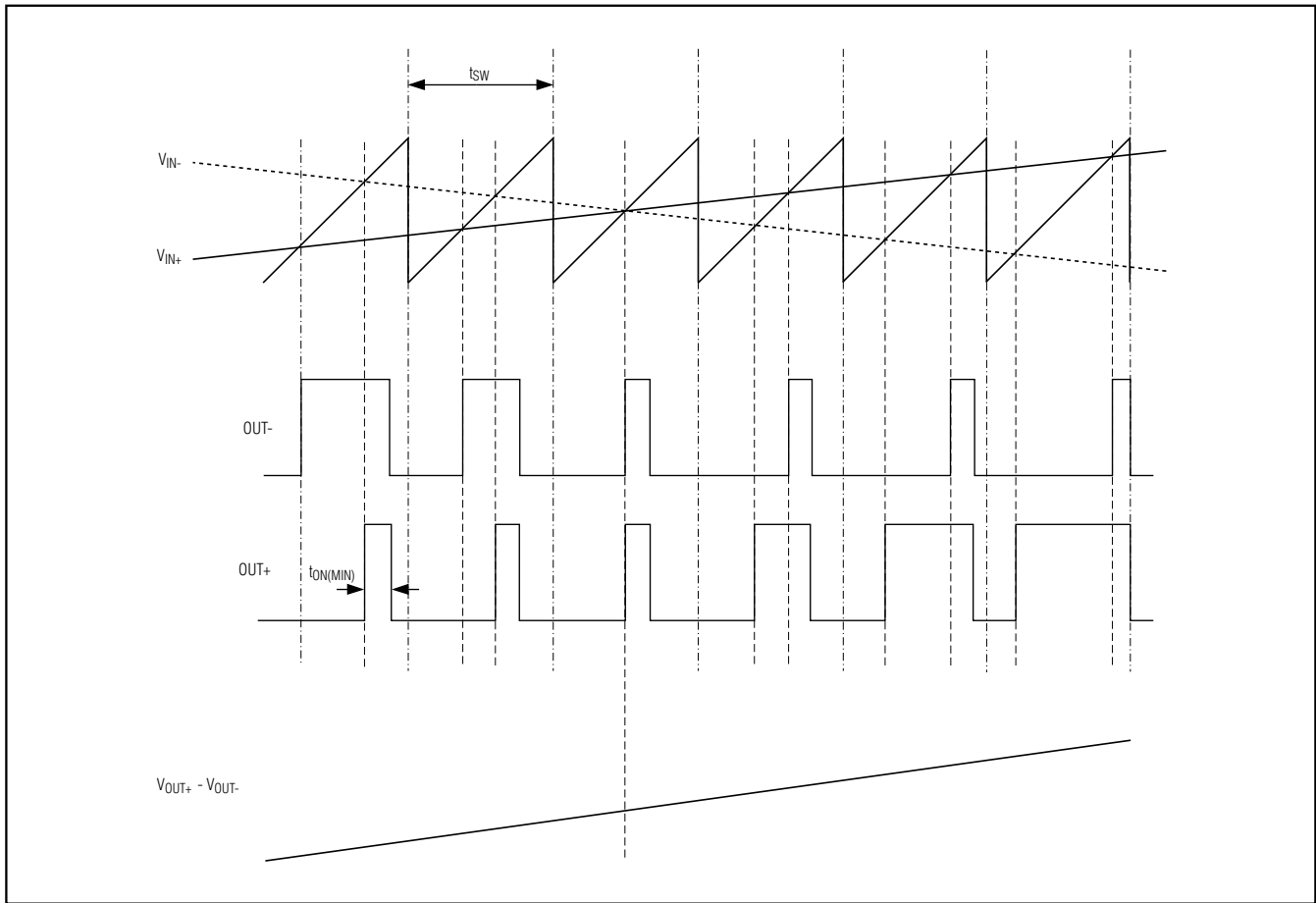

Figure 1. MAX9705 Outputs with an Input Signal Applied

Table 1. Operating Modes

SYNC INPUT	MODE
GND	FFM with $f_S = 1100\text{kHz}$
FLOAT	FFM with $f_S = 1450\text{kHz}$
V _{DD}	SSM with $f_S = 1220\text{kHz} \pm 120\text{kHz}$
Clocked	FFM with $f_S = \text{external clock frequency}$

improving EMI emissions by 5dB. Proprietary techniques ensure that the cycle-to-cycle variation of the switching period does not degrade audio reproduction or efficiency (see the *Typical Operating Characteristics*). Select SSM mode by setting SYNC = V_{DD}. In SSM mode, the switching frequency varies randomly by $\pm 120\text{kHz}$ around the center frequency (1.22MHz). The modulation scheme remains the same, but the period of the sawtooth waveform changes from cycle to cycle (Figure 2). Instead of a large amount of spectral energy present at multiples of

the switching frequency, the energy is now spread over a bandwidth that increases with frequency. Above a few megahertz, the wideband spectrum looks like white noise for EMI purposes (see the *EMI Spectrum Diagram*).

External Clock Mode

The SYNC input allows the MAX9705 to be synchronized to a system clock moving the spectral components of the switching harmonics to insensitive frequency bands. Applying an external TTL clock of 800kHz to 2MHz to SYNC synchronizes the switching frequency of the MAX9705. The period of the SYNC clock can be randomized, enabling the MAX9705 to be synchronized to another MAX9705 operating in SSM mode.

Filterless Modulation/Common-Mode Idle

The MAX9705 uses Maxim's unique, patented modulation scheme that eliminates the LC filter required by traditional Class D amplifiers, improving efficiency, reducing component count, and conserving board

2.3W, Ultra-Low-EMI, Filterless, Class D Audio Amplifier

MAX9705

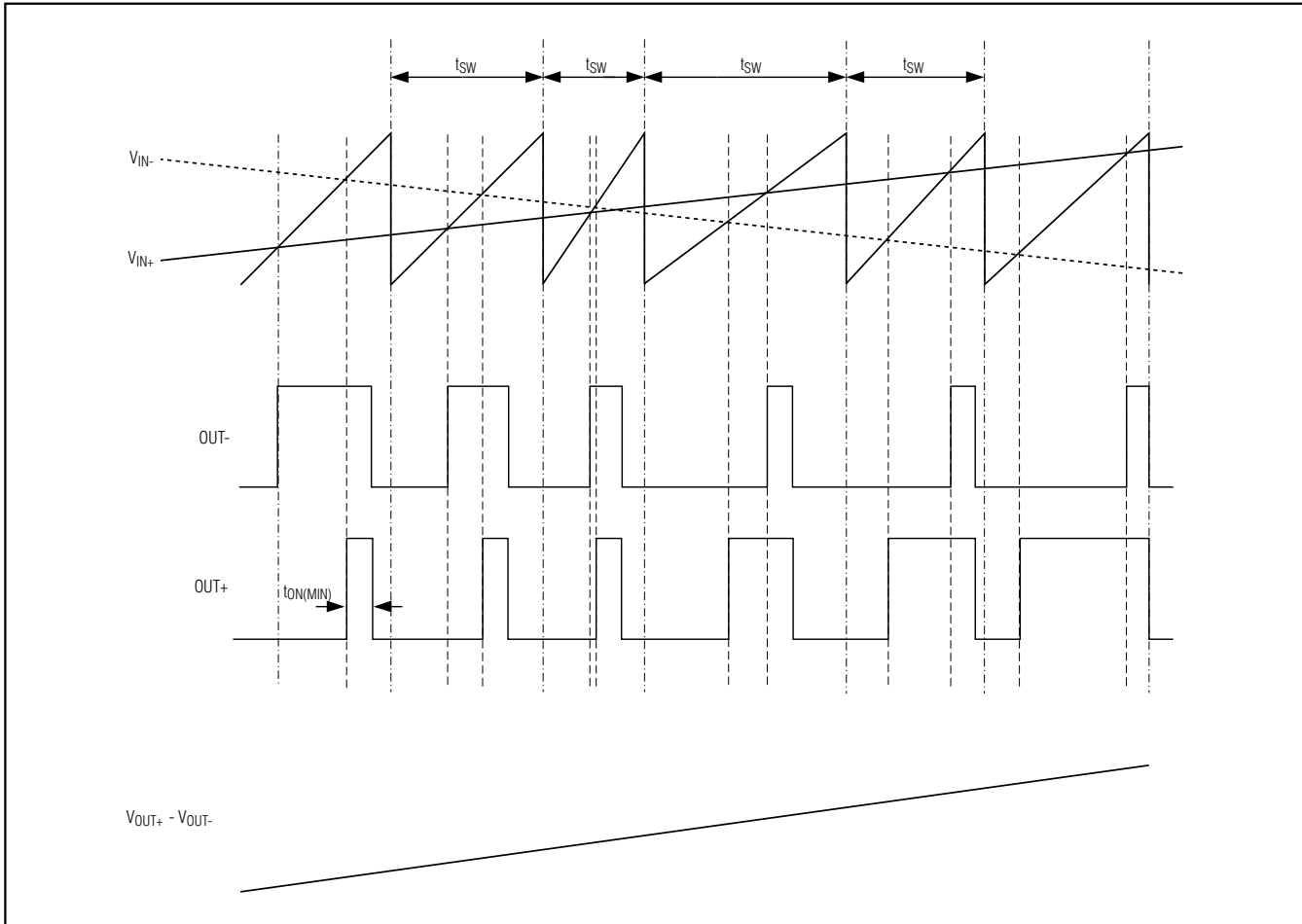

Figure 2. MAX9705 Output with an Input Signal Applied (SSM Mode)

space and system cost. Conventional Class D amplifiers output a 50% duty cycle square wave when no signal is present. With no filter, the square wave appears across the load as a DC voltage, resulting in a finite load current, increasing power consumption. When no signal is present at the input of the MAX9705, the outputs switch as shown in Figure 3. Because the MAX9705 drives the speaker differentially, the two outputs cancel each other, resulting in no net idle-mode voltage across the speaker, minimizing power consumption.

Efficiency

Efficiency of a Class D amplifier is attributed to the region of operation of the output stage transistors. In a Class D amplifier, the output transistors act as current-steering switches and consume negligible additional

power. Any power loss associated with the Class D output stage is mostly due to the I^2R loss of the MOSFET on-resistance and supply current.

The theoretical best efficiency of a linear amplifier is 78%; however, that efficiency is only exhibited at peak output powers. Under normal operating levels (typical music reproduction levels), efficiency falls below 30%, whereas the MAX9705 still exhibits >70% efficiencies under the same conditions (Figure 4).

Shutdown

The MAX9705 has a shutdown mode that reduces power consumption and extends battery life. Driving SHDN low places the MAX9705 in a low-power (0.3 μ A) shutdown mode. Connect SHDN to V_{DD} for normal operation.

2.3W, Ultra-Low-EMI, Filterless, Class D Audio Amplifier

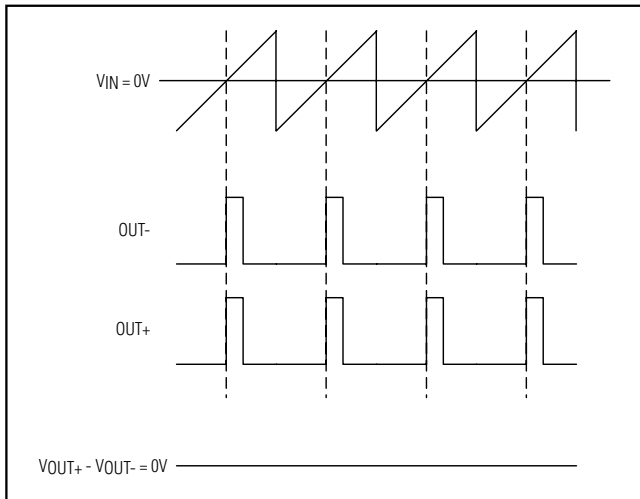

Figure 3. MAX9705 Outputs with No Input Signal

Click-and-Pop Suppression

The MAX9705 features comprehensive click-and-pop suppression that eliminates audible transients on start-up and shutdown. While in shutdown, the H-bridge is in a high-impedance state. During startup or power-up, the input amplifiers are muted and an internal loop sets the modulator bias voltages to the correct levels, preventing clicks and pops when the H-bridge is subsequently enabled. For 30ms following startup, a soft-start function gradually unmutes the input amplifiers.

Applications Information

Filterless Operation

Traditional Class D amplifiers require an output filter to recover the audio signal from the amplifier's output. The filters add cost, increase the solution size of the amplifier, and can decrease efficiency and THD+N performance. The traditional PWM scheme uses large differential output swings ($2 \times V_{DD}$ peak-to-peak) and causes large ripple currents. Any parasitic resistance in the filter components results in a loss of power, lowering the efficiency.

The MAX9705 does not require an output filter. The device relies on the inherent inductance of the speaker coil and the natural filtering of both the speaker and the human ear to recover the audio component of the square-wave output. Eliminating the output filter results in a smaller, less costly, more efficient solution.

Because the frequency of the MAX9705 output is well beyond the bandwidth of most speakers, voice coil movement due to the square-wave frequency is very small. Although this movement is small, a speaker not

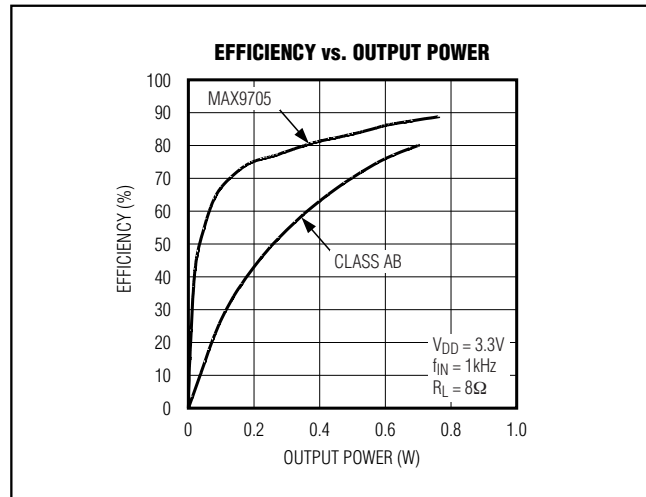

Figure 4. MAX9705 Efficiency vs. Class AB Efficiency

designed to handle the additional power can be damaged. For optimum results, use a speaker with a series inductance $>10\mu\text{H}$. Typical 8Ω speakers exhibit series inductances in the $20\mu\text{H}$ to $100\mu\text{H}$ range.

Power-Conversion Efficiency

Unlike a class AB amplifier, the output offset voltage of a Class D amplifier does not noticeably increase quiescent-current draw when a load is applied. This is due to the power conversion of the Class D amplifier. For example, an 8mV DC offset across an 8Ω load results in 1mA extra current consumption in a Class AB device. In the Class D case, an 8mV offset into 8Ω equates to an additional power drain of $8\mu\text{W}$. Due to the high efficiency of the Class D amplifier, this represents an additional quiescent-current draw of $8\mu\text{W}/(V_{DD}/100\eta)$, which is on the order of a few microamps.

Input Amplifier

Differential Input

The MAX9705 features a differential input structure, making it compatible with many CODECs, and offering improved noise immunity over a single-ended input amplifier. In devices such as cellular phones, high-frequency signals from the RF transmitter can be picked up by the amplifier's input traces. The signals appear at the amplifier's inputs as common-mode noise. A differential input amplifier amplifies the difference of the two inputs; any signal common to both inputs is canceled.

Single-Ended Input

The MAX9705 can be configured as a single-ended input amplifier by capacitively coupling either input to GND and driving the other input (Figure 5).

2.3W, Ultra-Low-EMI, Filterless, Class D Audio Amplifier

Note that the single-ended voltage range of the MAX9705A is 3V_{p-p}. This limits the achievable output power for this device. Use higher gain versions (MAX9705B, MAX9705C, MAX9705D) if higher output power is desired in a single-ended application.

DC-Coupled Input

The input amplifier can accept DC-coupled inputs that are biased within the amplifier's common-mode range (see the *Typical Operating Characteristics*). DC coupling eliminates the input-coupling capacitors, reducing component count to potentially one external component (see the *System Diagram*). However, the low-frequency rejection of the capacitors is lost, allowing low-frequency signals to feed through to the load.

Component Selection

Input Filter

An input capacitor, C_{IN}, in conjunction with the input resistance of the MAX9705 forms a highpass filter that removes the DC bias from an incoming signal. The AC-coupling capacitor allows the amplifier to bias the signal to an optimum DC level. Assuming zero source impedance, the -3dB point of the highpass filter is given by:

$$f_{-3dB} = \frac{1}{2\pi R_{IN} C_{IN}}$$

Choose C_{IN} so f_{-3dB} is well below the lowest frequency of interest. Setting f_{-3dB} too high affects the low-frequency response of the amplifier. Use capacitors whose dielectrics have low-voltage coefficients, such as tantalum or aluminum electrolytic. Capacitors with high-voltage coefficients, such as ceramics, may result in increased distortion at low frequencies. If a ceramic capacitor is selected due to size constraints, use the largest package possible to minimize voltage coefficient effects. In addition, use X7R dielectrics as opposed to Y5V or Z5U.

Other considerations when designing the input filter include the constraints of the overall system and the actual frequency band of interest. Although high-fidelity audio calls for a flat gain response between 20Hz and 20kHz, portable voice-reproduction devices such as cellular phones and two-way radios need only concentrate on the frequency range of the spoken human voice (typically 300Hz to 3.5kHz). In addition, speakers used in portable devices typically have a poor response below 150Hz. Taking these two factors into considera-

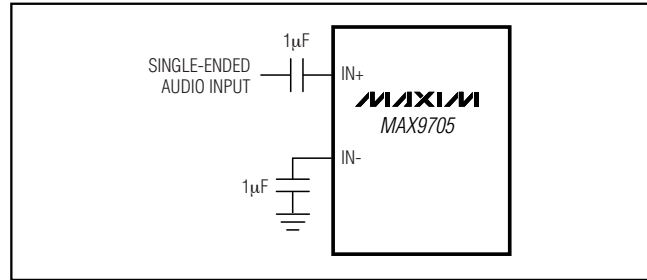

Figure 5. Single-Ended Input

tion, the input filter may not need to be designed for a 20Hz to 20kHz response, saving both board space and cost due to the use of smaller capacitors.

Output Filter

The MAX9705 does not require an output filter. The device passes FCC emissions standards with 24in of unshielded twisted-pair speaker cables. However, an output filter can be used if a design is failing radiated emissions due to board layout or excessive cable length, or the circuit is near EMI-sensitive devices.

Supply Bypassing/Layout

Proper power-supply bypassing ensures low-distortion operation. For optimum performance, bypass V_{DD} to GND and P_{VDD} to P_{GND} with separate 1µF capacitors as close to each pin as possible. A low-impedance, high-current power-supply connection to P_{VDD} is assumed. Additional bulk capacitance should be added as required depending on the application and power-supply characteristics. GND and P_{GND} should be star connected to system ground. Refer to the MAX9705 evaluation kit for layout guidance.

Stereo Configuration

Two MAX9705s can be configured as a stereo amplifier (Figure 6). Device U1 is the master amplifier; its unfiltered output drives the SYNC input of the slave device (U2), synchronizing the switching frequencies of the two devices. Synchronizing two MAX9705s ensures that no beat frequencies occur within the audio spectrum. This configuration works when the master device is in either FFM or SSM mode. There is excellent THD+N performance and minimal crosstalk between devices due to the SYNC connection (Figures 7 and 8). U2 locks onto only the frequency present at SYNC, not the pulse width. The internal feedback loop of device U2 ensures that the audio component of U1's output is rejected.

2.3W, Ultra-Low-EMI, Filterless, Class D Audio Amplifier

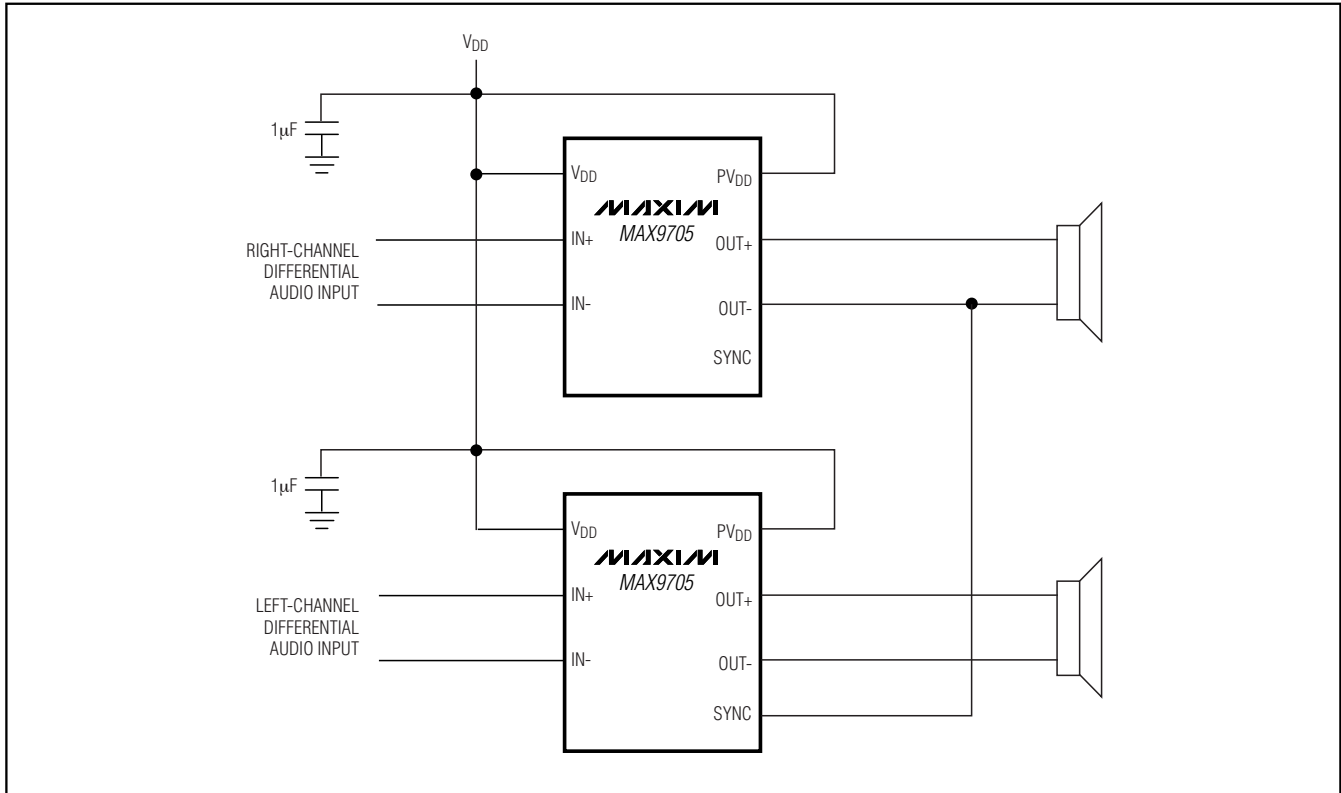

Figure 6. Master-Slave Stereo Configuration

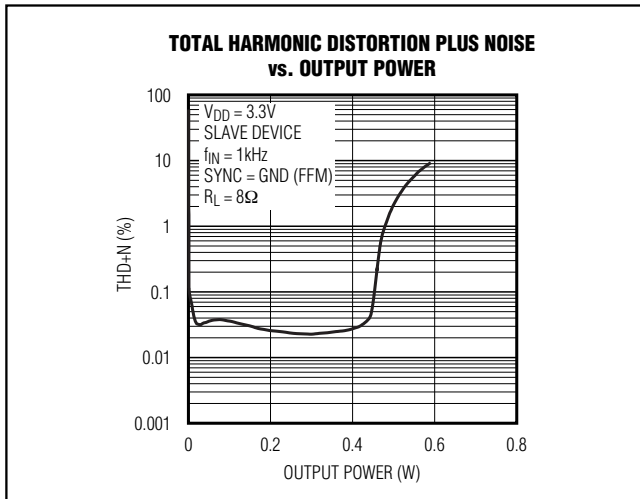

Figure 7. Master-Slave THD+N

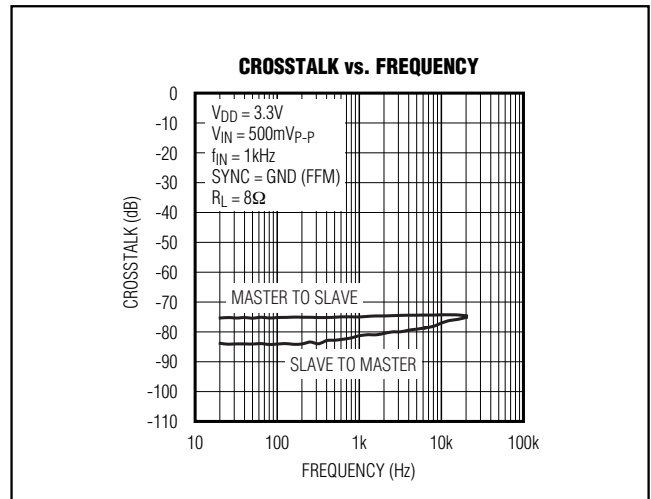

Figure 8. Master-Slave Crosstalk

2.3W, Ultra-Low-EMI, Filterless, Class D Audio Amplifier

MAX9705

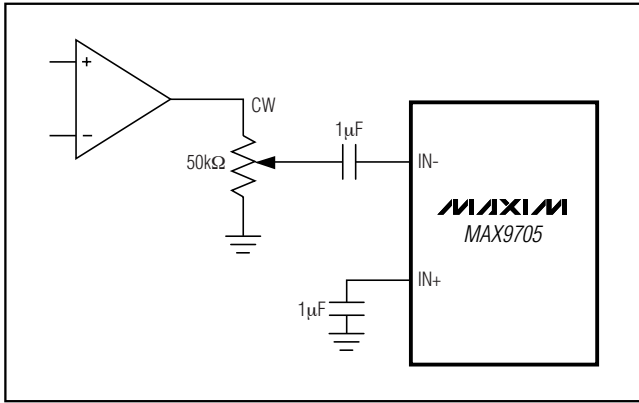

Figure 9a. Single-Ended Drive of MAX9705 Plus Volume

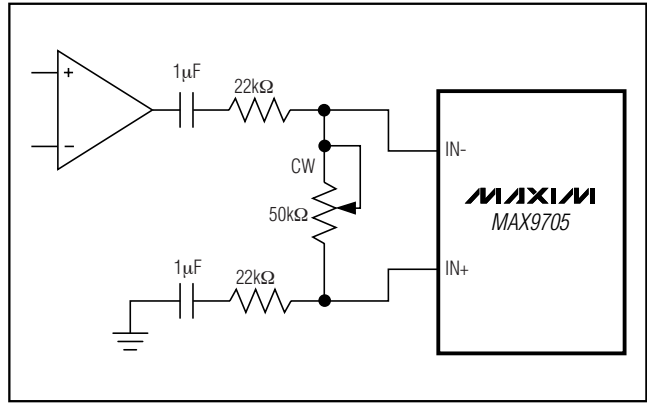
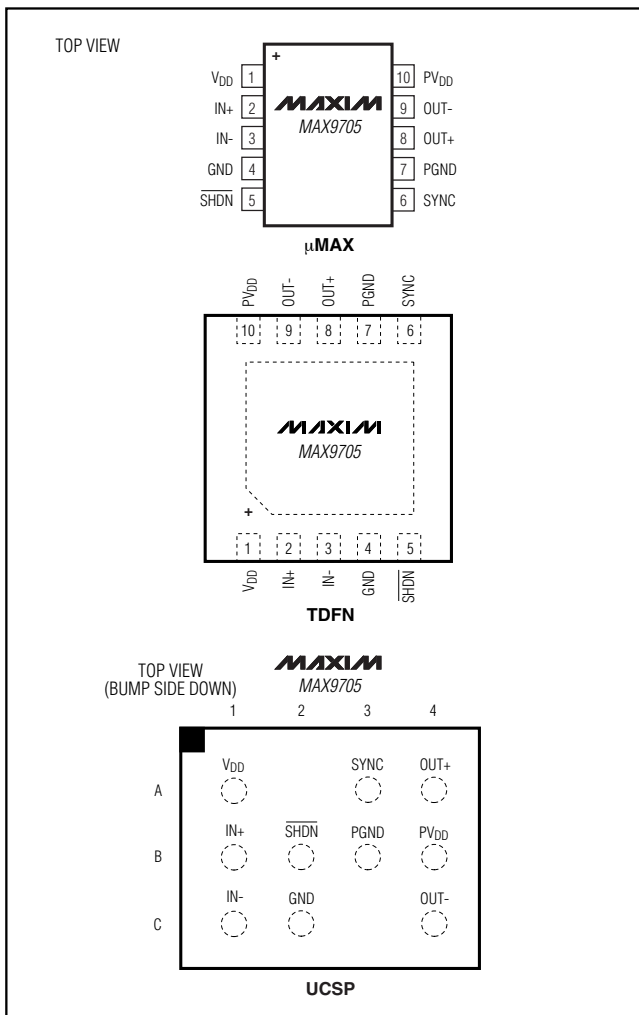

Figure 9b. Improved Single-Ended Drive of MAX9705 Plus Volume

Pin Configurations



Selector Guide

PART	PIN-PACKAGE	GAIN (dB)
MAX9705AETB+T	10 TDFN-10	6
MAX9705AEUB+	10 μMAX	6
MAX9705AEBC+T	12 UCSP-12	6
MAX9705BETB+T	10 TDFN-10	12
MAX9705BEUB+	10 μMAX	12
MAX9705BEBC+T	12 UCSP-12	12
MAX9705CETB+T	10 TDFN-10	15.6
MAX9705CEUB+	10 μMAX	15.6
MAX9705CEBC+T	12 UCSP-12	15.6
MAX9705DETb+T	10 TDFN-10	20
MAX9705DEUB+	10 μMAX	20
MAX9705DEBC+T	12 UCSP-12	20

Ordering Information (continued)

PART	TEMP RANGE	PIN-PACKAGE	TOP MARK
MAX9705CETB+T	-40°C to +85°C	10 TDFN-10	ACZ
MAX9705CEUB+	-40°C to +85°C	10 μMAX	—
MAX9705CEBC+T	-40°C to +85°C	12 UCSP-12	ACI
MAX9705DETb+T	-40°C to +85°C	10 TDFN-10	ADA
MAX9705DEUB+	-40°C to +85°C	10 μMAX	—
MAX9705DEBC+T	-40°C to +85°C	12 UCSP-12	ACJ

+Denotes lead-free package.

2.3W, Ultra-Low-EMI, Filterless, Class D Audio Amplifier

System Diagram

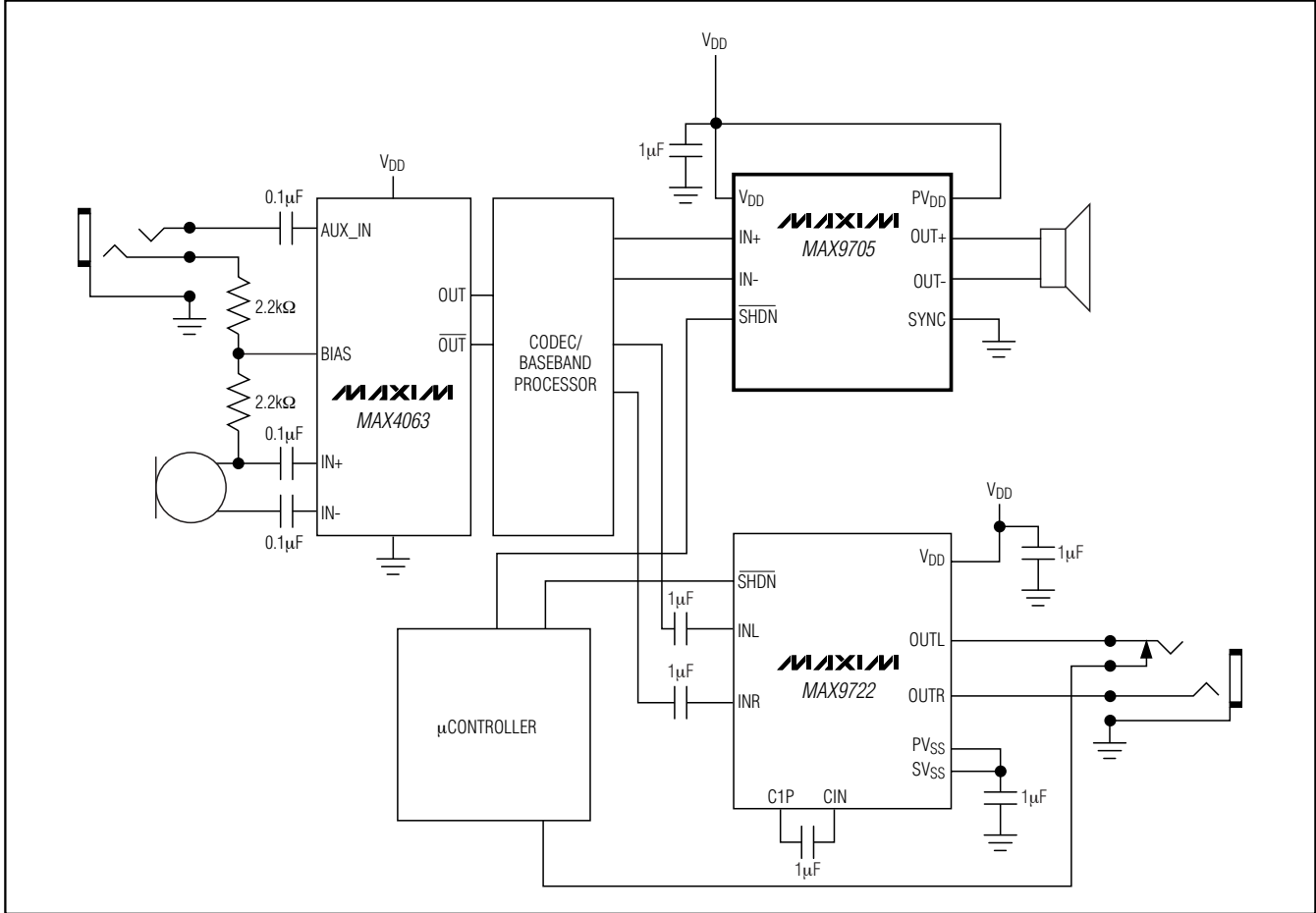

Chip Information

TRANSISTOR COUNT: 3595
 PROCESS: BiCMOS

2.3W, Ultra-Low-EMI, Filterless, Class D Audio Amplifier

Package Information

(The package drawing(s) in this data sheet may not reflect the most current specifications. For the latest package outline information go to www.maxim-ic.com/packages.)

MAX9705

12L, UCSP 4x3.EPS

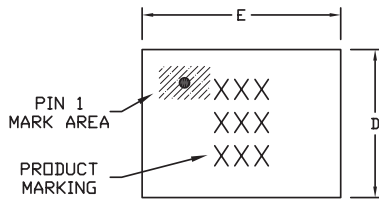

TOP VIEW

COMMON DIMENSIONS	
A	0.62±0.05-0.08
A1	0.29±0.02
A2	0.33 REF.
b	∅0.35±0.03
D1	1.00 BASIC
E1	1.50 BASIC
e	0.50 BASIC
SD	0.00 BASIC
SE	0.25 BASIC

PKG. CODE	VARIABLE DIMENSIONS		DEPOPULATED SOLDER BALLS
	D	E	
B12-1	1.54±0.05	2.02±0.05	NONE
B12-2	1.54±0.05	2.02±0.05	B3
B12-3	1.54±0.05	2.12±0.05	NONE
B12-4	1.54±0.05	2.02±0.05	B2, B3
B12-5	1.64±0.05	2.12±0.05	B2
B12-6	1.64±0.05	2.12±0.05	B3
B12-7	1.54±0.05	2.02±0.05	B1, B3
B12-8	1.54±0.05	2.02±0.05	B2
B12-9	1.54±0.05	2.12±0.05	B2, B3
B12-10	1.54±0.05	2.02±0.05	B1, B2, B3, B4
B12-11	1.54±0.05	2.02±0.05	A2, C3

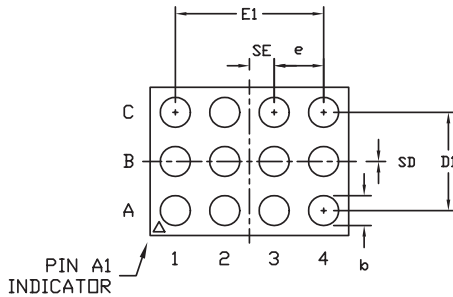

BOTTOM VIEW

- NOTES:
 1. ALL DIMENSIONS ARE IN MILLIMETERS.
 2. PRODUCT MARKING: NUMBER OF CHARACTERS AND LINES VARY PER PRODUCT.

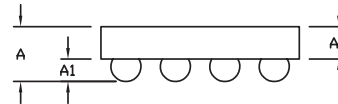

SIDE VIEW

PROPRIETARY INFORMATION		
TITLE: PACKAGE OUTLINE, 4x3 UCSP		
APPROVAL	DOCUMENT CONTROL NO. 21-0104	REV. F 1/1

2.3W, Ultra-Low-EMI, Filterless, Class D Audio Amplifier

MAX9705

Package Information (continued)

(The package drawing(s) in this data sheet may not reflect the most current specifications. For the latest package outline information go to www.maxim-ic.com/packages.)

COMMON DIMENSIONS		
SYMBOL	MIN.	MAX.
A	0.70	0.80
D	2.90	3.10
E	2.90	3.10
A1	0.00	0.05
L	0.20	0.40
k	0.25 MIN.	
A2	0.20 REF.	

PACKAGE VARIATIONS								
PKG. CODE	N	D2	E2	e	JEDEC SPEC	b	[(N/2)-1] x e	
T633-1	6	1.50±0.10	2.30±0.10	0.95 BSC	MO229 / WEEA	0.40±0.05	1.90 REF	
T633-2	6	1.50±0.10	2.30±0.10	0.95 BSC	MO229 / WEEA	0.40±0.05	1.90 REF	
T833-1	8	1.50±0.10	2.30±0.10	0.65 BSC	MO229 / WEEC	0.30±0.05	1.95 REF	
T833-2	8	1.50±0.10	2.30±0.10	0.65 BSC	MO229 / WEEC	0.30±0.05	1.95 REF	
T833-3	8	1.50±0.10	2.30±0.10	0.65 BSC	MO229 / WEEC	0.30±0.05	1.95 REF	
T1033-1	10	1.50±0.10	2.30±0.10	0.50 BSC	MO229 / WEED-3	0.25±0.05	2.00 REF	
T1033-2	10	1.50±0.10	2.30±0.10	0.50 BSC	MO229 / WEED-3	0.25±0.05	2.00 REF	
T1433-1	14	1.70±0.10	2.30±0.10	0.40 BSC	----	0.20±0.05	2.40 REF	
T1433-2	14	1.70±0.10	2.30±0.10	0.40 BSC	----	0.20±0.05	2.40 REF	

NOTES:

1. ALL DIMENSIONS ARE IN mm. ANGLES IN DEGREES.
 2. COPLANARITY SHALL NOT EXCEED 0.08 mm.
 3. WARPAGE SHALL NOT EXCEED 0.10 mm.
 4. PACKAGE LENGTH/PACKAGE WIDTH ARE CONSIDERED AS SPECIAL CHARACTERISTIC(S).
 5. DRAWING CONFORMS TO JEDEC MO229, EXCEPT DIMENSIONS "D2" AND "E2", AND T1433-1 & T1433-2.
 6. "N" IS THE TOTAL NUMBER OF LEADS.
 7. NUMBER OF LEADS SHOWN ARE FOR REFERENCE ONLY.
- ⚠ MARKING IS FOR PACKAGE ORIENTATION REFERENCE ONLY.

-DRAWING NOT TO SCALE-

			
TITLE: PACKAGE OUTLINE, 6, 8, 10 & 14L, TDFN, EXPOSED PAD, 3x3x0.80 mm			
APPROVAL	DOCUMENT CONTROL NO.	REV.	
	21-0137	H	2/2

2.3W, Ultra-Low-EMI, Filterless, Class D Audio Amplifier

Package Information (continued)

(The package drawing(s) in this data sheet may not reflect the most current specifications. For the latest package outline information go to www.maxim-ic.com/packages.)

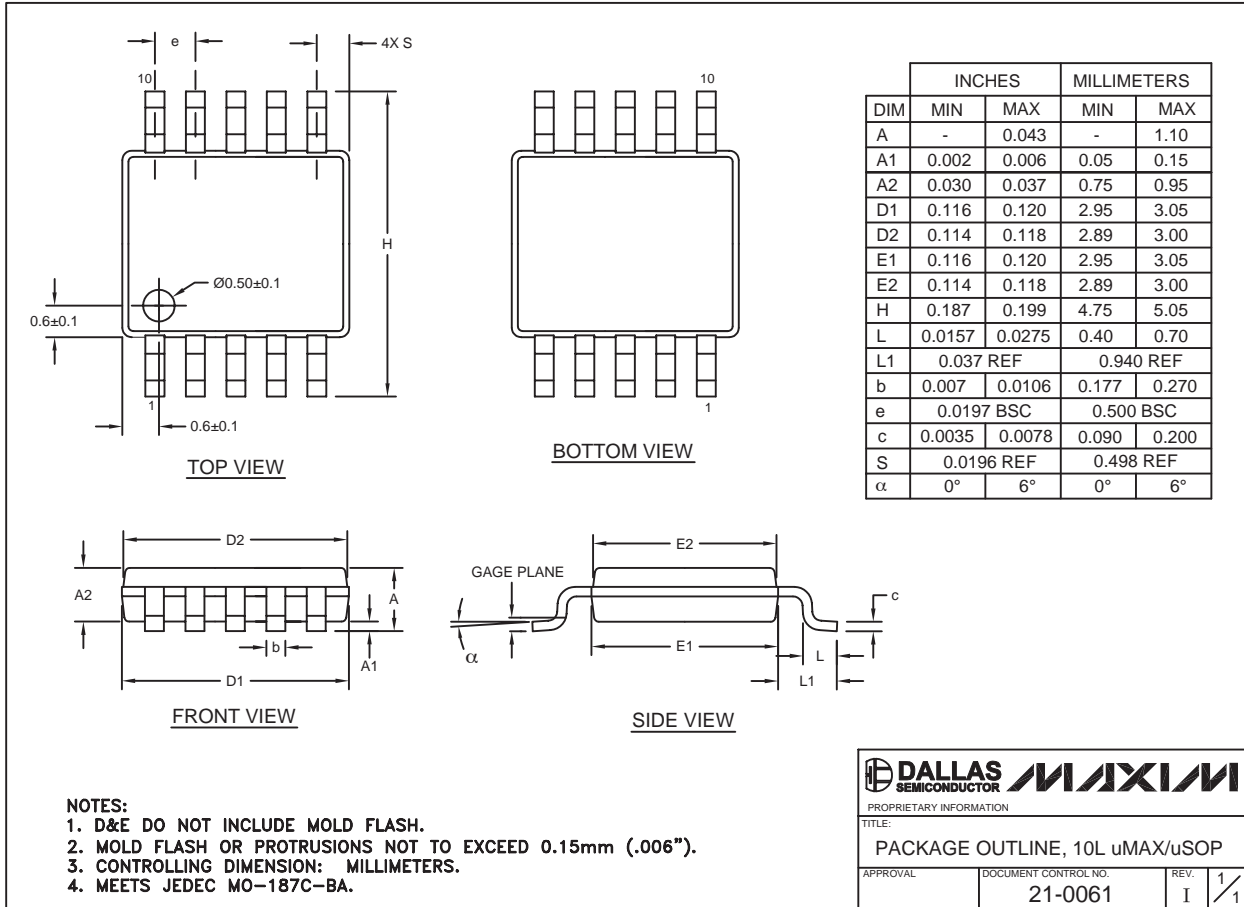

10LUMAX.EPS

Revision History

Pages changed at Rev 1: 1, 2-7, 9, 11, 13, 16, 20

Maxim cannot assume responsibility for use of any circuitry other than circuitry entirely embodied in a Maxim product. No circuit patent licenses are implied. Maxim reserves the right to change the circuitry and specifications without notice at any time.

20 Maxim Integrated Products, 120 San Gabriel Drive, Sunnyvale, CA 94086 408-737-7600