

**Preliminary** Toshiba Bipolar Linear Integrated Circuit Silicon Monolithic

# TA1317N

## Deflection Processor IC for TV

TA1317N is a deflection processor IC for a large and wide picture tube.

TA1317N incorporates EW, vertical distortion correction circuit and dynamic focus correction circuit. It can control various functions via I<sup>2</sup>C BUS line.

### Features

- Vertical drive (AC/DC-coupling)
- Picture height adjustment
- Vertical shift adjustment
- Vertical symmetry correction
- Vertical linearity correction
- Vertical S correction
- Vertical integral correction
- Vertical/Horizontal EHT compensation
- EW drive (parabola/PWM output)
- Picture width
- EW trapezium correction
- EW parabola correction
- EW corner correction (top only/bottom only/top&bottom)
- EW S correction
- Center curve correction (SAW/PAR)
- Parabola output for horizontal and vertical dynamic focus (H/V output independently)
- Horizontal and vertical dynamic focus phase adjustment
- Horizontal and vertical dynamic focus amplitude adjustment
- Horizontal dynamic focus curve characteristic adjustment
- V-ramp limiter circuit
- Analog blanking output

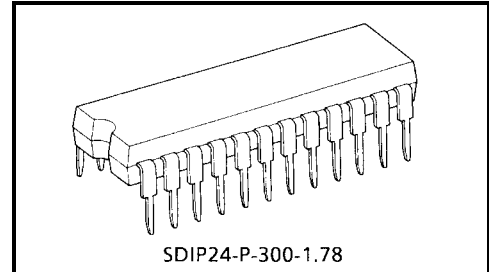

Weight: 1.22 g (typ.)

980910EBA1

- TOSHIBA is continually working to improve the quality and the reliability of its products. Nevertheless, semiconductor devices in general can malfunction or fail due to their inherent electrical sensitivity and vulnerability to physical stress. It is the responsibility of the buyer, when utilizing TOSHIBA products, to observe standards of safety, and to avoid situations in which a malfunction or failure of a TOSHIBA product could cause loss of human life, bodily injury or damage to property. In developing your designs, please ensure that TOSHIBA products are used within specified operating ranges as set forth in the most recent products specifications. Also, please keep in mind the precautions and conditions set forth in the TOSHIBA Semiconductor Reliability Handbook.
- The products described in this document are subject to the foreign exchange and foreign trade laws.
- The information contained herein is presented only as a guide for the applications of our products. No responsibility is assumed by TOSHIBA CORPORATION for any infringements of intellectual property or other rights of the third parties which may result from its use. No license is granted by implication or otherwise under any intellectual property or other rights of TOSHIBA CORPORATION or others.
- The information contained herein is subject to change without notice.



## Pin Functions

Pin No.	Pin Name	Function	Interface Circuit	Input/Output Signal
1	V <sub>REF</sub>	Internal reference voltage adjustment pin. If CRT DY has temperature coefficient, it can be cancelled in TV by applying inverse temperature coefficient to this pin. When pin is not used, connect 0.01 μF capacitor between pin and GND.		—
2	CENTER DAC	DAC output pin. When bus write function VD = 0, 2 bit DAC output; VD = 1, 7 bit DAC output.		DC
3	EHT IN	EHT input pin		DC
4	V DRIVE	Vertical output pin		—

Pin No.	Pin Name	Function	Interface Circuit	Input/Output Signal
5	V-DC REF	DC reference voltage output pin when V is DC coupling.		DC
6	V NF	Vertical negative feedback input pin. When VD = 0, if pin is 1.2 V (typ.) or below, or 3.7 V (typ.) or higher, returns abnormal detection result to BUS read function (V guard), forcibly setting pin 20 to High. When VD = 1, if pin is 2.4 V (typ.) or below, or 7.4 V (typ.) or higher, abnormality is detected.		
7	V <sub>CC</sub>	V <sub>CC</sub> pin. Connect 9 V (typ.).	—	—
8	EW PWM	EW D drive (PWM) output pin. Open collector output.		
9	ANALOG GND	GND pin for analog block	—	—
10	EW FD	EW feedback pin		

Pin No.	Pin Name	Function	Interface Circuit	Input/Output Signal
11	EW FILTER	Connect phase compensation filter for EW output. EW parabola waveform can be extracted from this pin.		—
12	FBP IN	FBP input pin		
13	SDA	SDA pin for I <sup>2</sup> C bus		
14	SCL	SCL pin for I <sup>2</sup> C bus		
15	DIGITAL GND	GND pin for digital block	—	—

Pin No.	Pin Name	Function	Interface Circuit	Input/Output Signal
16	H-DF OUT	Outputs parabola waveform for horizontal dynamic focus.		
17	LVP IN	LVP detection pin. Connect reference voltage used to protect deflection circuit against low supply voltage. If this pin is 5.0 V (typ.) or below, returns abnormal detection result to bus read function.		DC
18	V-DF OUT	Outputs parabola waveform for vertical dynamic focus.		
19	CENTER OUT	Outputs center curve correction waveform. Connect this pin to curve correction input pin of horizontal sync IC.		

Pin No.	Pin Name	Function	Interface Circuit	Input/Output Signal
20	BLK OUT	Analog blanking output pin. Open collector output.		
21	V <sub>IN</sub>	Inputs vertical trigger pulse. Notifies subsequent circuit of input fall as trigger.		
22	TC FILTER	Connects filter for generating internal pulse.		—
23	V-RAMP FILTER	Connects filter for generating vertical ramp signal.		—

Pin No.	Pin Name	Function	Interface Circuit	Input/Output Signal
24	AGC FILTER	Connects filter used to automatically adjust oscillation amplitude of vertical ramp signal. Can switch AGC sensitivity by BUS write function.		—

## Bus Control Map

### Write Mode

Slave Address: 8CH (10001100)

Sub-Address	D7	D6	D5	D4	D3	D2	D1	D0	Preset		
	MSB							LSB	MSB	LSB	
00	PICTURE HEIGHT							VD	1000	0000	
01	PICTURE WIDTH					V SHIFT			1000	0000	
02	V LINEARITY				V-EHT COMPENSATION				1000	0000	
03	ANALOG V-BLK STOP PHASE				H-EHT COMPENSATION				1000	0000	
04	ANALOG V-BLK START PHASE				V-RAMP 2				1000	0000	
05	V CENTERING							V-RAMP 1	1000	0000	
06	V-DF PHASE			V-DF AMPLITUDE						1000	1000
07	H-DF PHASE			H-DF AMPLITUDE						1000	1000
08	H-DF CURVE			V INTEGRAL CORRECTION						1000	0000
09	V AGC		V S CORRECTION						1000	0000	
0A	*	*	EW PARABOLA						1000	0000	
0B	EW TRAPEZIUM							V STOP	1000	0000	
0C	EW TOP CORNER				*	*	*	1000	0000		
0D	EW BOTTOM CORNER				*	*	*	1000	0000		
0E	EW S CORRECTION				*	*	*	1000	0000		
0F	EW CORNER				*	*	*	1000	0000		
10	CENTER PARABOLA				CENTER SAW				1000	1000	
11	V SYMMETRY								0000	0000	

### Read Mode

Slave Address: 8DH (10001101)

	D7	D6	D5	D4	D3	D2	D1	D0
	MSB							LSB
0	V DF	H DF	LVP	V NF	V GUARD	EW OUT	V OUT	POR

## Bus Control Function

### Write Mode

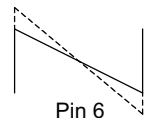
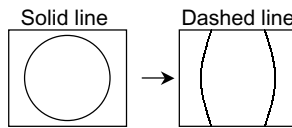
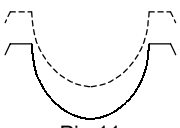
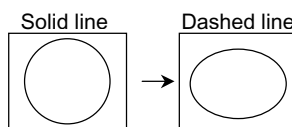
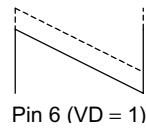
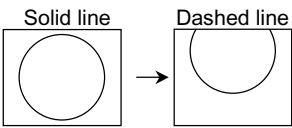
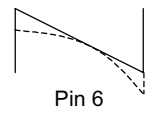
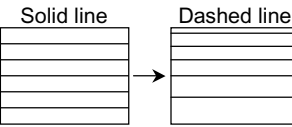

Register Name/Number of Bits	Function Explanation	Output Change	Picture Change	Preset
PICTURE HEIGHT/7	Adjusts the picture height. 0000000: -48%    1000000: 0%    1111111: +48%	 Pin 6	 Solid line    Dashed line	0% (1000000)
VD/1	Changes V-DRIVE mode 0: DC-coupling    1: AC-coupling	—	—	DC-coupling (0)
PICTURE WIDTH/6	Adjusts the picture width. 000000: 1.55 V    100000: 3.80 V    111111: 6.15 V	 Pin 11	 Solid line    Dashed line	3.80 V (100000)
V SHIFT/2	Where VD = 0, sets DAC output level of pin 2 is set. Where VD = 1, sets DC level of V-DRIVE is adjusted. 00: 0.5 V (VD = 0), 3.65 V (VD = 1) 11: 5.0 V (VD = 0), 6.20 V (VD = 1)	 Pin 6 (VD = 1)	 Solid line    Dashed line VD = 1	0.5 V (00)
V LINEARITY/5	Corrects the vertical linearity. 00000: -11.5%    10000: 0%    11111: +11.5%	 Pin 6	 Solid line    Dashed line	0% (10000)

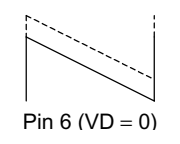
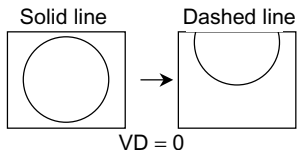
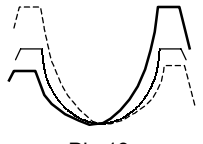
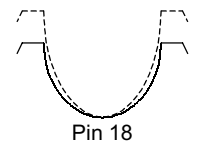
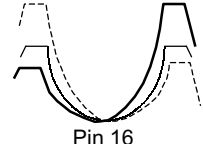

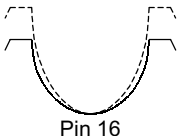
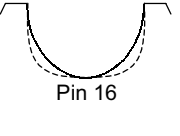
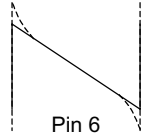
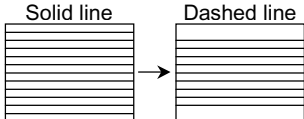
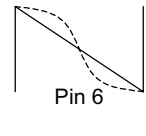
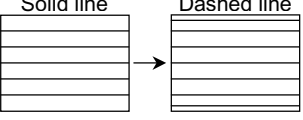
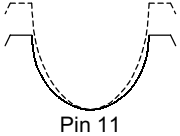
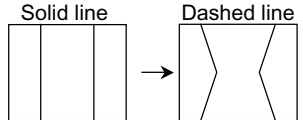
Register Name/Number of Bits	Function Explanation	Output Change	Picture Change	Preset
V CENTERING/7	Where VD = 0, DC level of V-DRIVE is adjusted. Where VD = 1, DAC output level of pin 2 is set. 0000000: -680 mV (VD = 0), 0.5 V (VD = 1) 1000000: 0 mV (VD = 0), 2.58 V (VD = 1) 1111111: +680 mV (VD = 0), 5.0 V (VD = 1)	 Pin 6 (VD = 0)	 Solid line → Dashed line VD = 0	-680 mV (0000000)
V-DF PHASE/4	Adjusts the phase of vertical dynamic focus output. 0000: -10%      1000: 0%      1111: +10%	 Pin 18	—	0% (1000)
V-DF AMPLITUDE/4	Adjusts the amplitude of vertical dynamic focus output. 0000: -10%      1000: 0%      1111: +10%	 Pin 18	—	0% (1000)
H-DF PHASE/4	Adjusts the phase of horizontal dynamic focus output. 0000: -7%      1000: 0%      1111: +7%	 Pin 16	—	0% (1000)

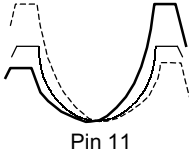
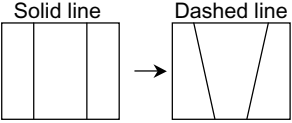
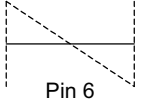
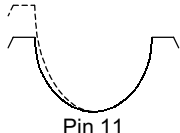
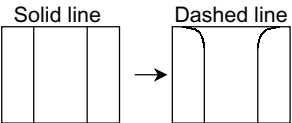
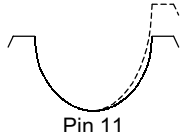
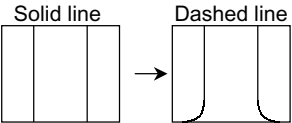
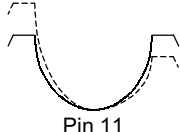
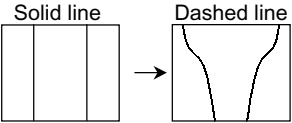
Register Name/Number of Bits	Function Explanation	Output Change	Picture Change	Preset
H-DF AMPLITUDE/4	Adjusts the amplitude of horizontal dynamic focus output. 0000: -10%      1000: 0%      1111: +10%	 Pin 16	—	0% (1000)
H-DF CURVE/4	Adjusts the curve characteristic of horizontal dynamic focus output. 0000: 100%      1111: 30%	 Pin 16	—	100% (0000)
V INTEGRAL CORRECTION/4	Adjusts the vertical integral correction. 0000: 0%      1111: 4.4%	 Pin 6	 Solid line      Dashed line	0% (0000)
V AGC/2	Sets the AGC gain for V-ramp. 00: HIGH      11: LOW	—	—	HIGH (00)
V S CORRECTION/6	Adjusts the vertical S correction. 000000: -24%      100000: 0%      111111: +24%	 Pin 6	 Solid line      Dashed line	-24% (000000)
EW PARABOLA/6	Adjusts the amplitude of EW output. 000000: 0 V <sub>p-p</sub> 111111: 3.3 V <sub>p-p</sub>	 Pin 11	 Solid line      Dashed line	0 V <sub>p-p</sub> (000000)

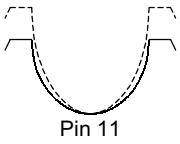
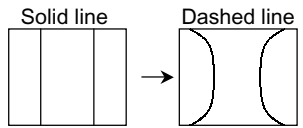
Register Name/Number of Bits	Function Explanation	Output Change	Picture Change	Preset
EW TRAPEZIUM/7	Adjusts the EW trapezium correction. 0000000: -11%    1000000: 0%    1111111: +11%	 Pin 11		0% (1000000)
V STOP/1	Switches over the V-stop mode. 0: Normal    1: V stop/BLK stop	 Pin 6	—	Normal (0)
EW TOP CORNER/5	Adjusts the EW top corner correction. 00000: -40%    10000: 0%    11111: +40%	 Pin 11		0% (10000)
EW BOTTOM CORNER/5	Adjusts the EW bottom corner correction. 00000: -40%    10000: 0%    11111: +40%	 Pin 11		0% (10000)
EW S CORRECTION/5	Adjusts the EW S correction. 00000: -32%    10000: 0%    11111: +32%	 Pin 11		0% (10000)

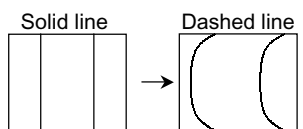
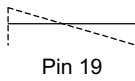
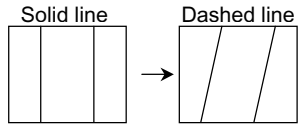
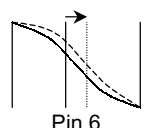
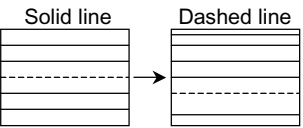
Register Name/Number of Bits	Function Explanation	Output Change	Picture Change	Preset
EW CORNER/5	Adjusts the EW corner correction. 00000: -42%    10000: 0%    11111: +42%			0% (10000)
CENTER PARABOLA/4	Adjusts the parabola-component amplitude. 0000: -2.2 V <sub>p-p</sub> 1000: 0 V <sub>p-p</sub> 1111: +2.2 V <sub>p-p</sub>			0 V <sub>p-p</sub> (1000)
CENTER SAW/4	Adjusts the saw-component amplitude. 0000: -4.7 V <sub>p-p</sub> 1000: 0 V <sub>p-p</sub> 1111: +4.7 V <sub>p-p</sub>			0 V <sub>p-p</sub> (1000)
V SYMMETRY/8	Corrects the vertical symmetry. 00000000: -9%    10000000: 0%    11111111: +9%			0% (10000000)

## Read Mode

Register Name/Number of Bits	Function Explanation
V DF/1	Vertical dynamic focus output self-check. 0: NG (no)                      1: OK (yes)
H DF/1	Horizontal dynamic focus output self-check. 0: NG (no)                      1: OK (yes)
LVP/1	LVP (low voltage protection) is detected. 0: OFF (pin 17 is high)    1: ON (pin 17 is low)
V NF/1	V-NF input self-check. 0: NG (no)                      1: OK (yes)
V GUARD/1	Detects abnormality on V-NF input. If abnormal, Pin 20 goes high. 0: OFF (normal)              1: ON (abnormal)
EW OUT/1	EW output self-check. 0: NG (no)                      1: OK (yes)
V OUT/1	V-DRIVE output self-check. 0: NG (no)                      1: OK (yes)
POR/1	Power-on reset. Responds 0 at first reading after power-on, 1 at second reading. 0: Resister preset            1: Normal

## Data Transfer Formats via I<sup>2</sup>C Bus

### Slave address

A6	A5	A4	A3	A2	A1	A0	W/R
1	0	0	0	1	1	0	0/1

### Start and Stop Condition

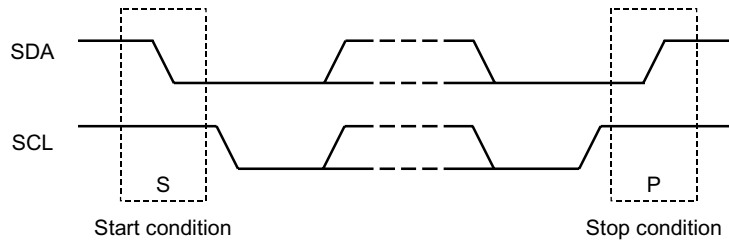

### Bit Transfer

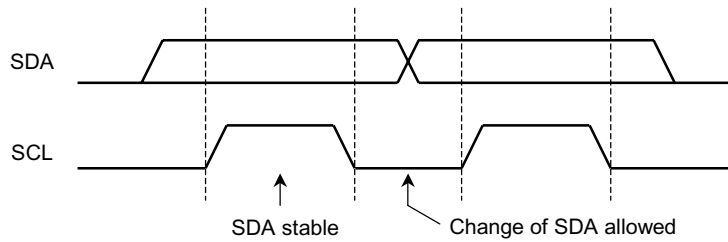

### Acknowledge

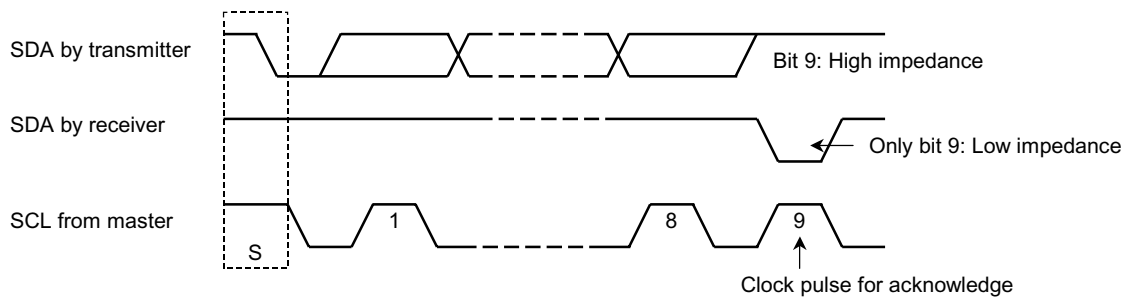

## Data Transmit Format 1

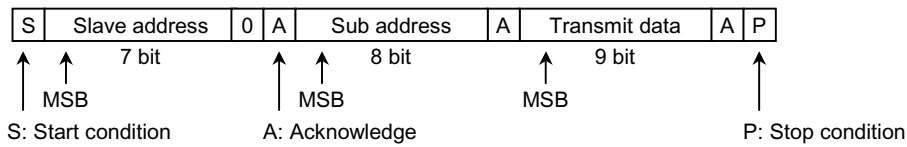

## Data Transmit Format 2

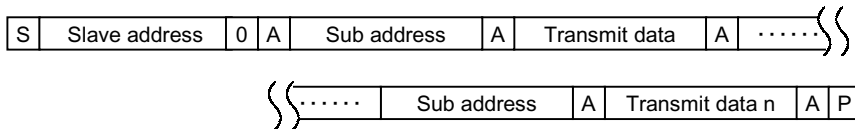

## Data Receive Format

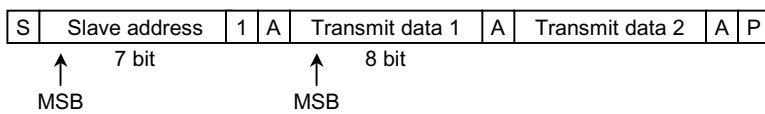

At the moment of the first acknowledge, the master transmitter becomes a master receiver and the slave transmitter. This acknowledge is still generated by this slave.

The Stop condition is generated by the master.

Details are provided in the Philips I<sup>2</sup>C specifications.

## Optional Data Transmit Format: Automatic Increment Mode



In this transmission method, data is set on automatically incremented sub-address from the specified sub-address.

Purchase of TOSHIBA I<sup>2</sup>C components conveys a license under the Philips I<sup>2</sup>C Patent Rights to use these components in an I<sup>2</sup>C system, provided that the system conforms to the I<sup>2</sup>C Standard Specification as defined by Philips.

**Maximum Ratings (Ta = 25°C)**

Characteristics	Symbol	Rating	Unit
Power Supply voltage	V <sub>CCmax</sub>	12	V
Input pin signal voltage	e <sub>inmax</sub>	9	V <sub>p-p</sub>
Power dissipation	P <sub>D</sub> (Note 1)	1250	mW
Power dissipation reduction rate	1/θ <sub>ja</sub>	-10	mW/°C
Operating temperature	T <sub>opr</sub>	-20~65	°C
Storage temperature	T <sub>stg</sub>	-55~150	°C

Note 1: See the figure below.

Note 2: Since the device is susceptible to surge, handle with care. Especially pin 32 has a low surge resistance.

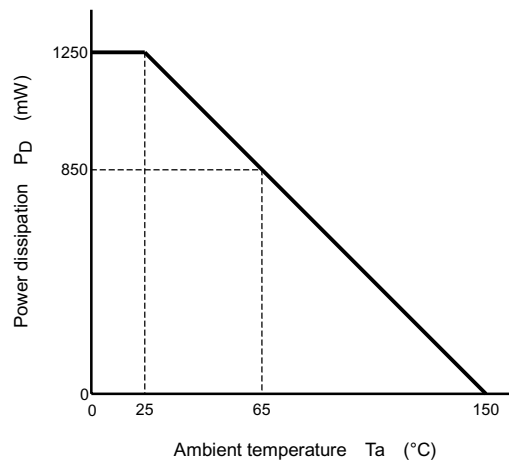

**Figure 1 PD – TA Curve**

**Recommended Operating Conditions**

Characteristics	Description	Min	Typ.	Max	Unit
Supply voltage (V <sub>CC</sub> )	Pin 7	8.5	9.0	9.5	V
EHT input voltage	Pin 3	0.0	—	9.0	V
FBP input amplitude	Pin 12	4.0	—	9.0	V
FBP input frequency	Pin 12	15.625	—	45	kHz
SCL/SDA pull-up voltage	Pins 13 & 14	3.0	5.0	9.0	V
LVP input voltage	Pin 17	0.0	—	9.0	V
V input amplitude	Pin 21	3.0	—	9.0	V
V input frequency	Pin 21	50	—	60	Hz

## Electrical Characteristics (unless otherwise specified, $V_{CC} = 9\text{ V}$ , $T_a = 25^\circ\text{C}$ )

### Current dissipation

Pin Name	Symbol	Test Circuit	Min	Typ.	Max	Unit
$V_{CC}$	$I_{CC}$	—	40	50.8	62	mA

### Pin voltages

Pin No.	Pin Name	Symbol	Test Circuit	Min	Typ.	Max	Unit
1	$V_{REF}$	$V_1$	—	4.60	4.88	5.10	V
5	V -DC REF	$V_5$	—	4.60	4.88	5.10	V

### AC Characteristics

Characteristics	Symbol	Test Circuit	Test Condition	Min	Typ.	Max	Unit
Vertical trigger input shaped voltage	$V_{TH}$	—	(Note 1)	1.50	1.65	1.80	V
Timing pulse output voltage	$V_{TCH}$	—	(Note 2)	3.90	4.10	4.30	V
	$V_{TCM}$	—		2.95	3.15	3.35	
	$V_{TCL}$	—		0.97	1.07	1.17	
Vertical ramp wave amplitude	$V_{RMP}$	—	(Note 3)	1.65	1.75	1.85	$V_{p-p}$
Vertical drive amplification	GV	—	(Note 4)	21	24	27	dB
Vertical drive output voltage	$V_{4H}$	—	(Note 5)	2.5	3.3	4.1	V
	$V_{4L}$	—		0.00	0.00	0.30	
Vertical NF signal amplitude	$V_{NFM}$	—	(Note 6)	1.65	1.85	2.05	$V_{p-p}$
Vertical phase adjustment 1 (V shift) change amount	$V_{DC}$ (80)	—	(Note 7)	3.10	3.65	4.20	V
	$V_{DC}$ (83)	—		5.65	6.20	6.75	
	$V_{DC}$	—		2.20	2.55	2.90	
Vertical phase adjustment 2 (V centering) change amount	$V_{DD}$ (00)	—	(Note 8)	1.64	1.82	2.00	V
	$V_{DD}$ (FE)	—		2.87	3.16	3.45	
	$V_{DD}$	—		1.21	1.34	1.47	
Vertical amplitude adjustment (picture height) change amount	$V_{NFL}$	—	(Note 9)	0.85	1.00	1.15	$V_{p-p}$
	$V_{NFH}$	—		2.55	2.75	2.95	
	$V_{NFP}$	—		43	48	53	%
	$V_{NFN}$	—		-53	-48	-43	
Vertical linearity correction (V linearity) change amount	$V_1$ (00)	—	(Note 10)	0.90	1.06	1.22	$V_{p-p}$
	$V_2$ (00)	—		0.69	0.81	0.93	
	$V_1$ (80)	—		0.82	0.96	1.10	
	$V_2$ (80)	—		0.77	0.91	1.05	
	$V_1$ (F8)	—		0.73	0.86	0.99	
	$V_2$ (F8)	—		0.85	1.00	1.15	
	$V_{LIN}$	—		9.5	10.5	12.5	%
Vertical symmetry (V symmetry) change amount	$V_{VT}$ (00)	—	(Note 11)	4.60	4.95	5.20	V
	$V_{VT}$ (FF)	—		5.40	5.70	6.00	
	$V_{VT}$	—		0.67	0.76	0.85	

Characteristics	Symbol	Test Circuit	Test Condition	Min	Typ.	Max	Unit
Vertical S correction (V S correction) change amount	V <sub>S</sub> (80)	—	(Note 12)	1.92	2.26	2.60	V <sub>p-p</sub>
	V <sub>S</sub> (8F)	—		1.27	1.50	1.73	
	V <sub>S</sub>	—		17	21	25	%
Vertical integral correction (V <sub>J</sub> correction) change amount	V <sub>J</sub> (80)	—	(Note 13)	1.54	1.82	2.10	V <sub>p-p</sub>
	V <sub>J</sub> (8F)	—		1.62	1.90	2.18	
	V <sub>J</sub>	—		3.0	4.3	5.4	%
Vertical EHT compensation (V EHT compensation) change amount	V <sub>E</sub> (80)	—	(Note 14)	1.58	1.86	2.14	V <sub>p-p</sub>
	V <sub>E</sub> (87)	—		1.44	1.69	1.94	
	V <sub>EHT</sub>	—		8.5	10.0	11.0	%
EHT input dynamic range	V <sub>EHL</sub>	—	(Note 15)	1.9	2.4	2.9	V
	V <sub>EHH</sub>	—		5.9	6.4	6.9	
Horizontal amplitude adjustment (picture width) change amount	V <sub>EV</sub> (FC)	—	(Note 16)	5.20	6.15	7.10	V
	V <sub>EV</sub> (00)	—		1.30	1.55	1.80	
	V <sub>EV</sub>	—		4.20	4.60	5.00	
Parabola amplitude adjustment (EW parabola) change amount	V <sub>PB</sub> (00)	—	(Note 17)	0.00	0.02	0.06	V <sub>p-p</sub>
	V <sub>PB</sub> (20)	—		1.6	2.0	2.3	
	V <sub>PB</sub> (3F)	—		2.8	3.3	3.8	
	V <sub>PB</sub>	—		2.8	3.3	3.8	
EW top corner correction (EW top corner) change amount	V <sub>TC</sub> (00)	—	(Note 18)	2.3	2.8	3.2	V <sub>p-p</sub>
	V <sub>TC</sub> (F8)	—		0.9	1.2	1.4	
	V <sub>TCP</sub>	—		35	40	45	%
	V <sub>TCN</sub>	—		-45	-40	-32	
EW bottom corner correction (EW bottom corner) change amount	V <sub>BC</sub> (00)	—	(Note 19)	2.4	2.8	3.2	V <sub>p-p</sub>
	V <sub>BC</sub> (F8)	—		1.0	1.2	1.4	
	V <sub>BCP</sub>	—		35	40	46	%
	V <sub>BCN</sub>	—		-45	-40	-35	
EW corner correction change amount	V <sub>M</sub> (00)	—	(Note 20)	2.4	2.8	3.2	V <sub>p-p</sub>
	V <sub>M</sub> (F8)	—		0.8	1.1	1.4	
	V <sub>MP</sub>	—		35	42	52	%
	V <sub>MN</sub>	—		-52	-42	-32	
EW S correction change amount	V <sub>S</sub> (00)	—	(Note 21)	2.2	2.6	3.0	V <sub>p-p</sub>
	V <sub>S</sub> (F8)	—		1.0	1.4	1.6	
	V <sub>SP</sub>	—		28	33	38	%
	V <sub>SN</sub>	—		-37	-32	-27	
EW trapezium correction change amount	V <sub>ET</sub> (00)	—	(Note 22)	2.4	2.7	3.0	ms
	V <sub>ET</sub> (FE)	—		-3.0	-2.7	-2.4	
	V <sub>ETP</sub>	—		11.0	13.5	16.0	%
	V <sub>ETN</sub>	—		-16.0	-13.5	-11.0	
Horizontal EHT compensation (H-EHT compensation) DC change amount	V <sub>HC</sub> (80)	—	(Note 23)	3.0	3.6	4.2	V
	V <sub>HC</sub> (87)	—		4.0	4.7	5.4	
	V <sub>HC</sub>	—		0.9	1.1	1.2	
Parabola amplitude EHT compensation	EHT (1)	—	(Note 24)	1.55	1.90	2.20	V <sub>p-p</sub>
	EHT (7)	—		1.65	2.00	2.30	
	EHT	—		2.7	4.0	5.3	%

Characteristics	Symbol	Test Circuit	Test Condition	Min	Typ.	Max	Unit
AGC operating current	V <sub>X</sub> (00)	—	(Note 25)	30	40	50	μA
	V <sub>X</sub> (40)	—		55	75	90	
	V <sub>X</sub> (80)	—		300	380	450	
	V <sub>X</sub> (C0)	—		600	800	940	
Sawtooth correction (cent saw) maximum amplitude	V <sub>N</sub> (8F)	—	(Note 26)	4.0	4.7	5.4	V <sub>p-p</sub>
	V <sub>N</sub> (80)	—		4.0	4.7	5.4	
Parabola correction (cent par) maximum amplitude	V <sub>P</sub> (F8)	—	(Note 27)	1.9	2.2	2.5	V <sub>p-p</sub>
	V <sub>P</sub> (08)	—		1.9	2.2	2.5	
Horizontal DF amplitude adjustment (H DF amp)	V <sub>HD</sub> (80)	—	(Note 28)	2.4	2.8	3.2	V <sub>p-p</sub>
	V <sub>HD</sub> (88)	—		2.7	3.1	3.7	
	V <sub>HD</sub> (8F)	—		2.9	3.4	4.0	
	V <sub>HDP</sub>	—		7	10	13	%
	V <sub>HDN</sub>	—		-15	-10	-7	
Horizontal DF phase adjustment (H DF phase)	T <sub>HD</sub> (08)	—	(Note 29)	-2.0	-4.4	-6.0	V <sub>p-p</sub>
	T <sub>HD</sub> (F8)	—		2.0	4.4	6.0	
	T <sub>HD</sub>	—		6.5	8.8	10.0	
Horizontal DF bathtub (H DF curve) adjustment	T <sub>HB</sub> (00)	—	(Note 30)	32.0	42.0	52.0	μs
	T <sub>HB</sub> (F0)	—		21.0	31.0	41.0	
	T <sub>HB</sub>	—		3.5	5.5	7.5	
Vertical DF amplitude adjustment (V DF amp)	V <sub>VD</sub> (80)	—	(Note 31)	2.05	2.40	2.75	V <sub>p-p</sub>
	V <sub>VD</sub> (88)	—		2.30	2.70	3.10	
	V <sub>VD</sub> (8F)	—		2.55	3.00	3.45	
	V <sub>VDP</sub>	—		7	10	13	%
	V <sub>VDN</sub>	—		-15	-10	-7	
Vertical DF phase adjustment (V DF phase)	T <sub>VD</sub> (08)	—	(Note 32)	-1.5	-2.0	-2.5	ms
	T <sub>VD</sub> (F8)	—		1.5	2.0	2.5	
	T <sub>VD</sub>	—		3.4	4.0	4.6	
LVP detection voltage	V <sub>LVP</sub>	—	(Note 33)	4.7	5.0	5.3	V
Vertical guard detection voltage	V <sub>VGH</sub>	—	(Note 34)	7.0	7.3	7.6	V
	V <sub>VGL</sub>	—		2.1	2.4	2.7	
Vertical guard detection output current (BLK-OUT output current)	I <sub>20</sub>	—	(Note 35)	450	630	750	mA
Vertical centering DAC output voltage 1 (V centering)	V <sub>CA</sub> (00)	—	(Note 36)	0.30	0.50	0.55	V
	V <sub>CA</sub> (FE)	—		4.7	5.0	5.3	
	V <sub>CA</sub>	—		0.02	0.04	0.06	
Vertical centering DAC output voltage 2 (V shift)	V <sub>CD</sub> (80)	—	(Note 37)	0.40	0.60	0.80	V
	V <sub>CD</sub> (83)	—		4.7	5.0	5.3	
	V <sub>CD</sub>	—		1.25	1.45	1.65	
Vertical centering change amount in V STOP mode	V <sub>Y</sub> (00)	—	(Note 38)	1.8	2.0	2.2	V
	V <sub>Y</sub> (80)	—		2.25	2.50	2.75	
	V <sub>Y</sub> (FE)	—		2.7	3.0	3.3	
Vertical NF signal amplitude at DC coupling	V <sub>DFB</sub>	—	(Note 39)	0.85	0.95	1.05	V <sub>p-p</sub>
Vertical NF center voltage at DC coupling	V <sub>C</sub>	—	(Note 40)	2.25	2.50	2.75	V

Characteristics	Symbol	Test Circuit	Test Condition	Min	Typ.	Max	Unit
Vertical ramp cut level	V <sub>CHL</sub>	—	(Note 41)	6.0	10.7	12.3	%
	V <sub>CHH</sub>	—		31.7	37.3	42.9	
	V <sub>CLL</sub>	—		5.0	17.3	19.9	
	V <sub>CLH</sub>	—		35.0	46.0	52.9	
Analog blanking phase	BLHL	—	(Note 42)	5.05	5.90	6.75	ms
	BLHM	—		2.30	2.70	3.10	
	BLHH	—		—	0.00	0.10	
	BLLL	—		5.10	6.00	6.90	
	BLLM	—		2.05	2.40	3.00	
	BLLH	—		—	0.00	0.10	
Parabola amplitude adjustment (EW parabola) change amount at PWM	V <sub>PP</sub> (00)	—	(Note 43)	0.00	0.02	0.06	V <sub>p-p</sub>
	V <sub>PP</sub> (20)	—		1.6	2.00	2.30	
	V <sub>PP</sub> (3F)	—		2.80	3.30	3.80	
	V <sub>PP</sub>	—		2.80	3.30	3.80	

## Test Condition

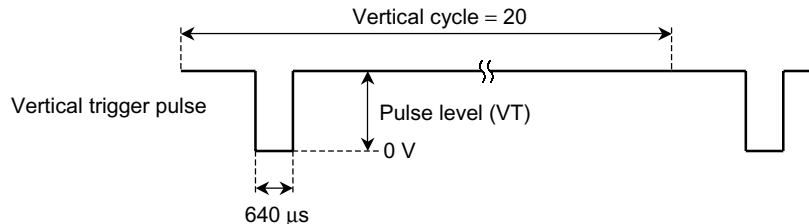
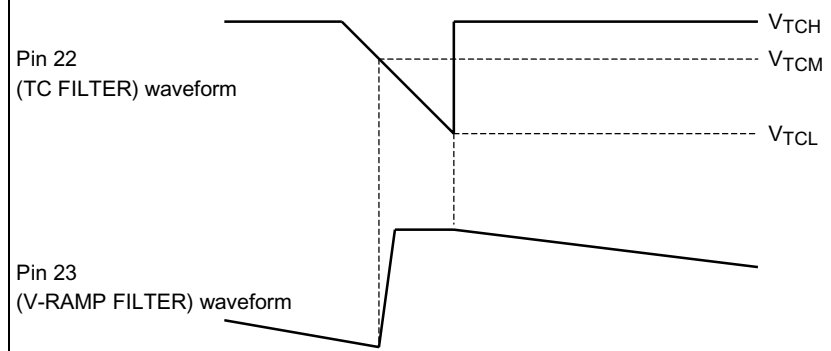
Note No.	Parameter	Test Condition								Test Method (unless otherwise specified, $V_{CC} = 9\text{ V}$ , $T_a = 25 \pm 3^\circ\text{C}$ , data = preset values)
		SW Mode								
		SW5	SW6	SW7	SW8	SW10	SW11	SW17	SW24	
1	Vertical trigger input shaped voltage	OFF	B	ON	OFF	B	ON	A	A	<p>(1) Input vertical trigger pulse (figure below) to pin <math>V_{IN}</math>.</p> <p>(2) Increase vertical trigger pulse level (<math>V_T</math>) from <math>0\text{ V}_{p-p}</math>. When timing pulse is output to pin 22 (TC FILTER), measure vertical trigger pulse level <math>V_{TH}</math>.</p> 
2	Timing pulse output voltage	OFF	B	ON	OFF	B	ON	A	A	<p>(1) Input vertical trigger pulse to pin <math>V_{IN}</math>. Pulse level (<math>V_T</math>) = <math>3.0\text{ V}</math></p> <p>(2) Measure pin 22 (TC FILTER) voltages (<math>V_{TCH}</math>, <math>V_{TCM}</math>, <math>V_{TCL}</math>) as shown in the figure below.</p> 

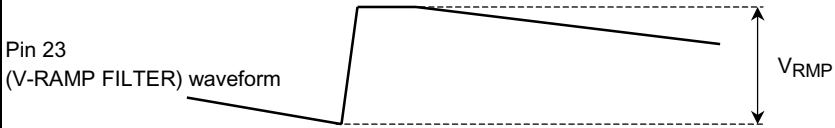
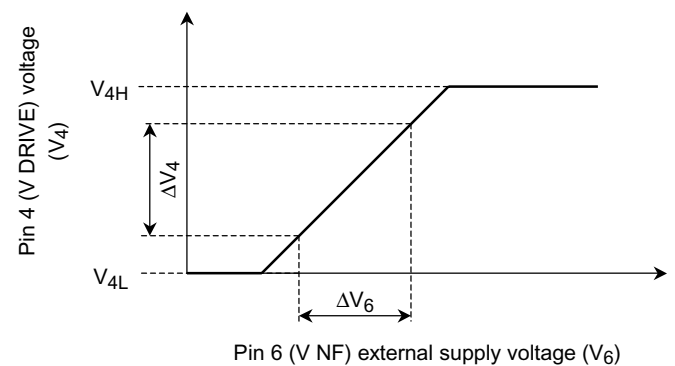
Note No.	Parameter	Test Condition								Test Method (unless otherwise specified, $V_{CC} = 9\text{ V}$ , $T_a = 25 \pm 3^\circ\text{C}$ , data = preset values)
		SW Mode								
		SW5	SW6	SW7	SW8	SW10	SW11	SW17	SW24	
3	Vertical ramp wave amplitude	OFF	B	ON	OFF	B	ON	A	A	<p>(1) Input vertical trigger pulse to pin <math>V_{IN}</math>. Pulse level (<math>V_T</math>) = 3.0 V</p> <p>(2) Measure pin 23 (V-RAMP FILTER) amplitude <math>V_{RMP}</math> as shown in the figure below.</p>  <p>Pin 23 (V-RAMP FILTER) waveform</p>
4	Vertical drive amplification	OFF	C	ON	OFF	B	ON	A	A	<p>(1) No signal input to pin <math>V_{IN}</math>.</p> <p>(2) Set VD (V-DRIVE mode switch) (sub-address: 00) to AC-Coupling mode (data: 81).</p> <p>(3) Connect external power supply to TP6 (V fb).</p> <p>(4) Change external power supply (<math>V_6</math>) from 0 to 6 V. Monitor pin 4 (V DRIVE) voltage <math>V_4</math>.</p> <p>(5) As shown in the figure below, change <math>V_6</math> and measure <math>V_4</math> change amounts (<math>\Delta V_6</math>, <math>\Delta V_4</math>). Calculate amplification GV using the following formula.</p>  <p>Pin 4 (V DRIVE) voltage (<math>V_4</math>)</p> <p>Pin 6 (V NF) external supply voltage (<math>V_6</math>)</p> $GV = 20 \log \left[ \frac{\Delta V_4}{\Delta V_6} \right]$

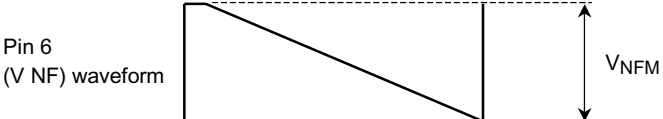
Note No.	Parameter	Test Condition								Test Method (unless otherwise specified, $V_{CC} = 9\text{ V}$ , $T_a = 25 \pm 3^\circ\text{C}$ , data = preset values)
		SW Mode								
		SW5	SW6	SW7	SW8	SW10	SW11	SW17	SW24	
5	Vertical drive output voltage	OFF	C	ON	OFF	B	ON	A	A	(1) Measure $V_{4H}$ using the figure for Note 4. (2) Measure $V_{4L}$ using the figure for Note 4.
6	Vertical NF signal amplitude	OFF	C	ON	OFF	B	ON	A	A	(1) Input vertical trigger pulse to pin $V_{IN}$ . Pulse level ( $V_T$ ) = 3.0 V (2) Set VD (sub-address: 00) to AC-Coupling mode (data: 81). (3) Set V INTEGRAL CORRECTION (sub-address: 08) to center (data: 88). (4) Set V S CORRECTION (sub-address: 09) to center (data: A0). (5) Set V SHIFT (sub-address: 01) data to 82. (6) Measure Pin 6 (V NF) vertical sawtooth amplitude $V_{NFM}$ .  

Note No.	Parameter	Test Condition								Test Method (unless otherwise specified, $V_{CC} = 9\text{ V}$ , $T_a = 25 \pm 3^\circ\text{C}$ , data = preset values)
		SW Mode								
		SW5	SW6	SW7	SW8	SW10	SW11	SW17	SW24	
7	Vertical phase adjustment 1 (V shift) change amount	OFF	B	ON	OFF	B	ON	A	A	<p>(1) Input vertical trigger pulse to pin <math>V_{IN}</math>. Pulse level (<math>V_T</math>) = 3.0 V</p> <p>(2) Set VD (sub-address: 00) to AC-Coupling mode (data: 81).</p> <p>(3) Set V INTEGRAL CORRECTION (sub-address: 08) to center (data: 88).</p> <p>(4) Set V S CORRECTION (sub-address: 09) to center (data: A0).</p> <p>(5) Set V SHIFT (sub-address: 01) to minimum (data: 80) and measure <math>V_{DC}</math> (80) as shown in the figure below.</p> <p>(6) Set V SHIFT (sub-address: 01) to maximum (data: 83) and measure <math>V_{DC}</math> (83) as shown in the figure below.</p> <p>(7) Calculate change amount <math>V_{DC}</math> using the following formula.</p> <div style="text-align: center;"> <p>Pin 6 (V NF) waveform</p> <p><math>V_{DC}</math> (83)</p> <p><math>V_{DC}</math> (80)</p> <p>10 ms      10 ms</p> </div> <p><math>V_{DC} = V_{DC} (83) - V_{DC} (80)</math></p>

Note No.	Parameter	Test Condition								Test Method (unless otherwise specified, $V_{CC} = 9\text{ V}$ , $T_a = 25 \pm 3^\circ\text{C}$ , data = preset values)
		SW Mode								
		SW5	SW6	SW7	SW8	SW10	SW11	SW17	SW24	
8	Vertical phase adjustment 2 (V centering) change amount	ON	A	OFF	OFF	B	ON	A	A	<p>(1) Input vertical trigger pulse to pin <math>V_{IN}</math>. Pulse level (<math>V_T</math>) = 3.0 V</p> <p>(2) Set VD (sub-address: 00) to DC-Coupling mode (data: 80).</p> <p>(3) Set V INTEGRAL CORRECTION (sub-address: 08) to center (data: 88).</p> <p>(4) Set V S CORRECTION (sub-address: 09) to center (data: A0).</p> <p>(5) Set V CENTERING (sub-address: 05) to minimum (data: 00) and measure <math>V_{DD} (00)</math> as shown in the figure below.</p> <p>(6) Set V CENTERING (sub-address: 05) to maximum (data: FE) and measure <math>V_{DD} (FE)</math> as shown in the figure below.</p> <p>(7) Calculate change amount <math>V_{DD}</math> using the following formula.</p> <div style="text-align: center;"> <p>Pin 6 (V NF) waveform</p> <p><math>V_{DD} (FE)</math></p> <p><math>V_{DD} (00)</math></p> <p>10 ms      10 ms</p> </div> <p><math>V_{DD} = V_{DD} (FE) - V_{DD} (00)</math></p>

Note No.	Parameter	Test Condition								Test Method (unless otherwise specified, V <sub>CC</sub> = 9 V, Ta = 25 ± 3°C, data = preset values)
		SW Mode								
		SW5	SW6	SW7	SW8	SW10	SW11	SW17	SW24	
9	Vertical amplitude adjustment (picture height) change amount	OFF	B	ON	OFF	B	ON	A	A	<p>(1) Input vertical trigger pulse to pin V<sub>IN</sub>. Pulse level (VT) = 3.0 V</p> <p>(2) Set VD (sub-address: 00) to AC-Coupling mode (data: 81).</p> <p>(3) Set V INTEGRAL CORRECTION (sub-address: 08) to center (data: 88).</p> <p>(4) Set V S CORRECTION (sub-address: 09) to center (data: A0).</p> <p>(5) Set V SHIFT (sub-address: 01) data to 82.</p> <p>(6) Set PICTURE HEIGHT (sub-address: 00) to minimum (data: 01) and measure Pin 6 (V<sub>NF</sub>) amplitude (V<sub>NFL</sub>).</p> <p>(7) Set PICTURE HEIGHT (sub-address: 00) to maximum (data: FF) and measure Pin 6 (V<sub>NF</sub>) amplitude (V<sub>NFH</sub>).</p> <p>(8) Determine variable ranges (V<sub>NFP</sub>, V<sub>NFN</sub>) using the following formulas.</p> <div style="text-align: center;"> <p>Pin 6 (V<sub>NF</sub>) waveform</p> </div> $V_{NFP} = \frac{V_{NFH} - V_{NFM}}{V_{NFM}} \times 100, \quad V_{NFN} = \frac{V_{NFL} - V_{NFM}}{V_{NFM}} \times 100$

Note No.	Parameter	Test Condition								Test Method (unless otherwise specified, $V_{CC} = 9\text{ V}$ , $T_a = 25 \pm 3^\circ\text{C}$ , data = preset values)
		SW Mode								
		SW5	SW6	SW7	SW8	SW10	SW11	SW17	SW24	
10	Vertical linearity correction (V linearity) change amount	OFF	B	ON	OFF	B	ON	A	A	<p>(1) Input vertical trigger pulse to pin <math>V_{IN}</math>. Pulse level (<math>V_T</math>) = 3.0 V</p> <p>(2) Set VD (sub-address: 00) to AC-Coupling mode (data: 81).</p> <p>(3) Set V INTEGRAL CORRECTION (sub-address: 08) to center (data: 88).</p> <p>(4) Set V S CORRECTION (sub-address: 09) to center (data: A0).</p> <p>(5) Set V SHIFT (sub-address: 01) data to 82.</p> <p>(6) Set V LINEARITY (sub-address: 02) to minimum (data: 00) and measure <math>V_1</math> (00) and <math>V_2</math> (00) as shown in the figure below.</p> <p>(7) Set V LINEARITY (sub-address: 02) to center (data: 80) and measure <math>V_1</math> (80) and <math>V_2</math> (80) as shown in the figure below.</p> <p>(8) Set V LINEARITY (sub-address: 02) to maximum (data: F8) and measure <math>V_1</math> (F8) and <math>V_2</math> (F8) as shown in the figure below.</p> <p>(9) Calculate maximum correction <math>V_{LIN}</math> from measured result using the following formula.</p> <div style="text-align: center;"> </div> $V_{LIN} = \frac{V_1(00) - V_1(F8) + V_2(F8) - V_2(00)}{2 \times [V_1(80) + V_2(80)]} \times 100$

Note No.	Parameter	Test Condition								Test Method (unless otherwise specified, $V_{CC} = 9\text{ V}$ , $T_a = 25 \pm 3^\circ\text{C}$ , data = preset values)
		SW Mode								
		SW5	SW6	SW7	SW8	SW10	SW11	SW17	SW24	
11	Vertical symmetry (V symmetry) change amount	OFF	B	ON	OFF	B	ON	A	A	<p>(1) Input vertical trigger pulse to pin <math>V_{IN}</math>. Pulse level (<math>V_T</math>) = 3.0 V</p> <p>(2) Set VD (sub-address: 00) to AC-Coupling mode (data: 81).</p> <p>(3) Set V INTEGRAL CORRECTION (sub-address: 08) to center (data: 88).</p> <p>(4) Set V S CORRECTION (sub-address: 09) to center (data: A0).</p> <p>(5) Set V SHIFT (sub-address: 01) data to 82.</p> <p>(6) Set V SYMMETRY (sub-address: 11) to minimum (data: 00) and measure Pin 6 (V NF) voltage <math>V_{VT}</math> (00).</p> <p>(7) Set V SYMMETRY (sub-address: 11) to maximum (data: FF) and measure Pin 6 (V NF) voltage <math>V_{VT}</math> (FF).</p> <p>(8) Calculate change amount <math>V_{VT}</math> using the following formula.</p> <div style="text-align: center;"> </div> <p><math>V_{VT} = V_{VT} (FF) - V_{VT} (00)</math></p>

Note No.	Parameter	Test Condition								Test Method (unless otherwise specified, V <sub>CC</sub> = 9 V, Ta = 25 ± 3°C, data = preset values)
		SW Mode								
		SW5	SW6	SW7	SW8	SW10	SW11	SW17	SW24	
12	Vertical S correction (V S correction) change amount	OFF	B	ON	OFF	B	ON	A	A	<p>(1) Input vertical trigger pulse to pin V<sub>IN</sub>. Pulse level (VT) = 3.0 V</p> <p>(2) Set VD (sub-address: 00) to AC-Coupling mode (data: 81).</p> <p>(3) Set V INTEGRAL CORRECTION (sub-address: 08) to center (data: 88).</p> <p>(4) Set V SHIFT (sub-address: 01) to 82.</p> <p>(5) Set V S CORRECTION (sub-address: 09) to minimum (data: 80) and measure V<sub>S</sub> (80) as shown in the figure below.</p> <p>(6) Set V S CORRECTION (sub-address: 09) to maximum (data: BF) and measure V<sub>S</sub> (BF) as shown in the figure below.</p> <p>(7) Calculate maximum correction V<sub>S</sub> using measured result and the following formula.</p> <div style="text-align: center;"> <p>Pin 6 (V NF) waveform</p> </div> $V_S = \frac{V_S(80) - V_S(8F)}{V_S(80) + V_S(8F)} \times 100$

Note No.	Parameter	Test Condition								Test Method (unless otherwise specified, V <sub>CC</sub> = 9 V, Ta = 25 ± 3°C, data = preset values)
		SW Mode								
		SW5	SW6	SW7	SW8	SW10	SW11	SW17	SW24	
13	Vertical integral correction (V <sub>f</sub> correction) change amount	OFF	B	ON	OFF	B	ON	A	A	<p>(1) Input vertical trigger pulse to pin V<sub>IN</sub>. Pulse level (V<sub>T</sub>) = 3.0 V</p> <p>(2) Set VD (sub-address: 00) to AC-Coupling mode (data: 81).</p> <p>(3) Set V S CORRECTION (sub-address: 09) to center (data: A0).</p> <p>(4) Set V SHIFT (sub-address: 01) to 82.</p> <p>(5) Set V INTEGRAL CORRECTION (sub-address: 08) to minimum (data: 80) and measure V<sub>f</sub> (80) as shown in the figure below.</p> <p>(6) Set V INTEGRAL CORRECTION (sub-address: 08) to maximum (data: 8F) and measure V<sub>f</sub> (8F) as shown in the figure below.</p> <p>(7) Calculate maximum correction V<sub>f</sub> from measured result using the following formula.</p> <div style="text-align: center;"> </div> $V_f = \frac{V_f (8F) - V_f (80)}{V_f (80)} \times 100$

Note No.	Parameter	Test Condition								Test Method (unless otherwise specified, V <sub>CC</sub> = 9 V, Ta = 25 ± 3°C, data = preset values)
		SW Mode								
		SW5	SW6	SW7	SW8	SW10	SW11	SW17	SW24	
14	Vertical EHT compensation (V EHT compensation) change amount	OFF	B	ON	OFF	B	ON	A	A	(1) Input vertical trigger pulse to pin V <sub>IN</sub> . Pulse level (VT) = 3.0 V (2) Set VD (sub-address: 00) to AC-Coupling mode (data: 81). (3) Set V SHIFT (sub-address: 01) data to 82. (4) Connect external power supply (DC voltage = 0 V) to pin 3 (EHT IN). (5) Set V-EHT COMPENSATION (sub-address: 02) to minimum (data: 80) and measure Pin 6 (V NF) amplitude V <sub>E</sub> (80). (6) Set V-EHT COMPENSATION (sub-address: 02) to maximum (data: 87) and measure Pin 6 (V NF) amplitude V <sub>E</sub> (87). (7) Calculate change amount V <sub>EHT</sub> using the following formula. $V_{EHT} = \frac{V_E(80) - V_E(87)}{V_E(87)} \times 100$

Note No.	Parameter	Test Condition								Test Method (unless otherwise specified, $V_{CC} = 9\text{ V}$ , $T_a = 25 \pm 3^\circ\text{C}$ , data = preset values)
		SW Mode								
		SW5	SW6	SW7	SW8	SW10	SW11	SW17	SW24	
15	EHT input dynamic range	OFF	B	ON	OFF	B	ON	A	A	(1) Input vertical trigger pulse to pin $V_{IN}$ . Pulse level (VT) = 3.0 V (2) Set VD (sub-address: 00) to AC-Coupling mode (data: 81). (3) Set V SHIFT (sub-address: 01) data to 82. (4) Connect external power supply $V_3$ to pin 3 (EHT IN). (5) Set V-EHT COMPENSATION (sub-address: 02) to maximum (data: 87). (6) Change external power supply $V_3$ from 1 to 7 V and monitor Pin 6 (V NF) amplitude. (7) When Pin 6 (V NF) amplitude changes, measure $V_3$ voltages $V_{EHL}$ and $V_{EHH}$ .
										<p style="text-align: center;">Pin 6 (V NF) amplitude</p> <p style="text-align: center;">Voltage applied to pin 3 (EHT IN) (<math>V_3</math>)</p> <p style="text-align: center;"><math>V_{EHL}</math>      <math>V_{EHH}</math></p>
16	Horizontal amplitude adjustment (picture width) change amount	OFF	B	ON	OFF	B	ON	A	A	(1) Input vertical trigger pulse to pin $V_{IN}$ . Pulse level (VT) = 3.0 V (2) Set EW PARABOLA (sub-address: 0A) to minimum (data: 00). (3) Set PICTURE WIDTH (sub-address: 01) to maximum (data: FC) and measure Pin 10 (EW FD) voltage $V_{EV}$ (FC). (4) Set PICTURE WIDTH (sub-address: 01) to minimum (data: 00) and measure Pin 10 (EW FD) voltage $V_{EV}$ (00). (5) Calculate change amount $V_{EV}$ using the following formula. $V_{EV} = V_{EV}(\text{FC}) - V_{EV}(\text{00})$

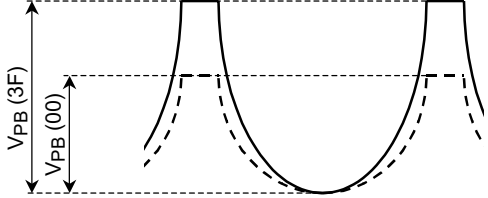
Note No.	Parameter	Test Condition								Test Method (unless otherwise specified, $V_{CC} = 9\text{ V}$ , $T_a = 25 \pm 3^\circ\text{C}$ , data = preset values)
		SW Mode								
		SW5	SW6	SW7	SW8	SW10	SW11	SW17	SW24	
17	Parabola amplitude adjustment (EW parabola) change amount	OFF	B	ON	OFF	B	ON	A	A	<p>(1) Input vertical trigger pulse to pin <math>V_{IN}</math>. Pulse level (<math>V_T</math>) = 3.0 V</p> <p>(2) Set PICTURE WIDTH (sub-address: 01) to maximum (data: FC).</p> <p>(3) Apply external power supply (DC voltage = 7 V) to pin 3 (EHT IN).</p> <p>(4) Set EW PARABOLA (sub-address: 0A) to minimum (data: 00) and measure Pin 10 (EW FD) amplitude <math>V_{PB}</math> (00).</p> <p>(5) Set EW PARABOLA (sub-address: 0A) to center (data: 20) and measure Pin 10 (EW FD) amplitude <math>V_{PB}</math> (20).</p> <p>(6) Set EW PARABOLA (sub-address: 0A) to maximum (data: 3F) and measure Pin 10 (EW FD) amplitude <math>V_{PB}</math> (3F).</p> <p>(7) Calculate change amount <math>V_{PB}</math> using the following formula.</p> <div style="text-align: center;">  <p>Pin 10 (EW FD) waveform</p> </div> <p><math>V_{PB} = V_{PB} (3F) - V_{PB} (00)</math></p>

Note No.	Parameter	Test Condition								Test Method (unless otherwise specified, $V_{CC} = 9\text{ V}$ , $T_a = 25 \pm 3^\circ\text{C}$ , data = preset values)
		SW Mode								
		SW5	SW6	SW7	SW8	SW10	SW11	SW17	SW24	
18	EW top corner correction (EW top corner) change amount	OFF	B	ON	OFF	B	ON	A	A	<p>(1) Input vertical trigger pulse to pin <math>V_{IN}</math>. Pulse level (<math>V_T</math>) = 3.0 V</p> <p>(2) Apply external power supply (DC voltage = 7 V) to pin 3 (EHT IN).</p> <p>(3) Set EW PARABOLA (sub-address: 0A) to center (data: 20).</p> <p>(4) Set EW TOP CORNER (sub-address: 0C) to minimum (data: 00) and measure Pin 10 (EW FD) amplitude <math>V_{TC}</math> (00).</p> <p>(5) Set EW TOP CORNER (sub-address: 0C) to maximum (data: F8) and measure Pin 10 (EW FD) amplitude <math>V_{TC}</math> (F8).</p> <p>(6) Calculate change amounts <math>V_{TCP}</math> and <math>V_{TCN}</math> using the following formulas.</p> <div style="text-align: center;"> <p>Pin 10 (EW FD) waveform</p> </div> $V_{TCP} = \frac{V_{TC} (00) - V_{PB} (20)}{V_{PB} (20)} \times 100$ $V_{TCN} = \frac{V_{TC} (F8) - V_{PB} (20)}{V_{PB} (20)} \times 100$

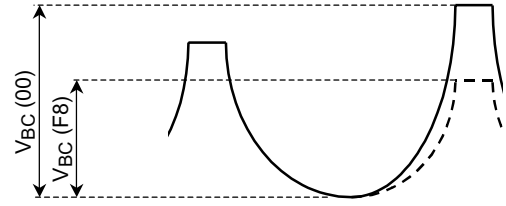
Note No.	Parameter	Test Condition								Test Method (unless otherwise specified, V <sub>CC</sub> = 9 V, Ta = 25 ± 3°C, data = preset values)
		SW Mode								
		SW5	SW6	SW7	SW8	SW10	SW11	SW17	SW24	
19	EW bottom corner correction (EW bottom corner) change amount	OFF	B	ON	OFF	B	ON	A	A	<p>(1) Input vertical trigger pulse to pin V<sub>IN</sub>. Pulse level (VT) = 3.0 V</p> <p>(2) Apply external power supply (DC voltage = 7 V) to pin 3 (EHT IN).</p> <p>(3) Set EW PARABOLA (sub-address: 0A) to center (data: 20).</p> <p>(4) Set EW BTM CORNER (sub-address: 0D) to minimum (data: 00) and measure Pin 10 (EW FD) amplitude V<sub>BC</sub> (00).</p> <p>(5) Set EW BTM CORNER (sub-address: 0D) to maximum (data: F8) and measure Pin 10 (EW FD) amplitude V<sub>BC</sub> (F8).</p> <p>(6) Calculate change amounts V<sub>BCP</sub> and V<sub>BCN</sub> using the following formulas.</p> <div style="text-align: center;">  <p>Pin 10 (EW FD) waveform</p> </div> $V_{BCP} = \frac{V_{BC} (00) - V_{PB} (20)}{V_{PB} (20)} \times 100$ $V_{BCN} = \frac{V_{BC} (F8) - V_{PB} (20)}{V_{PB} (20)} \times 100$

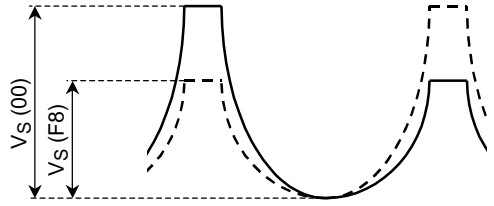

Note No.	Parameter	Test Condition								Test Method (unless otherwise specified, $V_{CC} = 9\text{ V}$ , $T_a = 25 \pm 3^\circ\text{C}$ , data = preset values)
		SW Mode								
		SW5	SW6	SW7	SW8	SW10	SW11	SW17	SW24	
20	EW corner correction change amount	OFF	B	ON	OFF	B	ON	A	A	<p>(1) Input vertical trigger pulse to pin <math>V_{IN}</math>. Pulse level (<math>V_T</math>) = 3.0 V</p> <p>(2) Apply external power supply (DC voltage = 7 V) to pin 3 (EHT IN).</p> <p>(3) Set EW PARABOLA (sub-address: 0A) to center (data: 20).</p> <p>(4) Set EW CORNER (sub-address: 0F) to minimum (data: 00) and measure Pin 10 (EW FD) amplitude <math>V_M</math> (00).</p> <p>(5) Set EW CORNER (sub-address: 0F) to maximum (data: F8) and measure Pin 10 (EW FD) amplitude <math>V_M</math> (F8).</p> <p>(6) Calculate change amounts <math>V_{MP}</math> and <math>V_{MN}</math> using the following formulas.</p> <div style="text-align: center;"> <p>Pin 10 (EW FD) waveform</p> </div> $V_{MP} = \frac{V_M(00) - V_{PB}(20)}{V_{PB}(20)} \times 100$ $V_{MN} = \frac{V_M(F8) - V_{PB}(20)}{V_{PB}(20)} \times 100$

Note No.	Parameter	Test Condition								Test Method (unless otherwise specified, V <sub>CC</sub> = 9 V, Ta = 25 ± 3°C, data = preset values)
		SW Mode								
		SW5	SW6	SW7	SW8	SW10	SW11	SW17	SW24	
21	EW S correction change amount	OFF	B	ON	OFF	B	ON	A	A	<p>(1) Input vertical trigger pulse to pin V<sub>IN</sub>. Pulse level (VT) = 3.0 V</p> <p>(2) Apply external power supply (DC voltage = 7 V) to pin 3 (EHT IN).</p> <p>(3) Set EW PARABOLA (sub-address: 0A) to center (data: 20).</p> <p>(4) Set S CORRECTION (sub-address: 0E) to minimum (data: 00) and measure Pin 10 (EW FD) amplitude V<sub>S</sub> (00).</p> <p>(5) Set S CORRECTION (sub-address: 0E) to maximum (data: F8) and measure Pin 10 (EW FD) amplitude V<sub>S</sub> (F8).</p> <p>(6) Calculate change amounts V<sub>SP</sub> and V<sub>SN</sub> using the following formulas.</p> <div style="text-align: center;">  <p>Pin 10 (EW FD) waveform</p> </div> $V_{SP} = \frac{V_S(00) - V_{PB}(20)}{V_{PB}(20)} \times 100$ $V_{SN} = \frac{V_S(F8) - V_{PB}(20)}{V_{PB}(20)} \times 100$

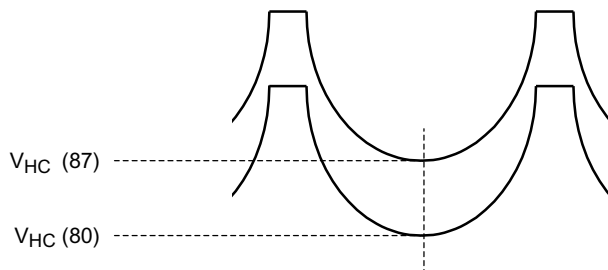
Note No.	Parameter	Test Condition								Test Method (unless otherwise specified, $V_{CC} = 9\text{ V}$ , $T_a = 25 \pm 3^\circ\text{C}$ , data = preset values)
		SW Mode								
		SW5	SW6	SW7	SW8	SW10	SW11	SW17	SW24	
22	EW trapezium correction change amount	OFF	B	ON	OFF	B	ON	A	A	<p>(1) Input vertical trigger pulse to pin <math>V_{IN}</math>. Pulse level (<math>V_T</math>) = 3.0 V</p> <p>(2) Apply external power supply (DC voltage = 7 V) to pin 3 (EHT IN).</p> <p>(3) Set EW PARABOLA (sub-address: 0A) to maximum (data: 3F).</p> <p>(4) Set EW TRAPEZIUM (sub-address: 0B) to minimum (data: 00) and measure Pin 10 (EW FD) amplitude <math>V_{ET}</math> (00).</p> <p>(5) Set EW TRAPEZIUM (sub-address: 0B) to maximum (data: FE) and measure Pin 10 (EW FD) amplitude <math>V_{ET}</math> (FE).</p> <p>(6) Calculate change amounts <math>V_{ETP}</math> and <math>V_{ETN}</math> using the following formulas.</p> <div style="text-align: center;"> <p><math>V_{ET} (FE)</math>   <math>V_{ET} (00)</math></p> <p>Pin 10 (EW FD) waveform</p> </div> $V_{ETP} = \frac{V_{ET} (FE)}{20} \times 100$ $V_{ETN} = \frac{V_{ET} (00)}{20} \times 100$

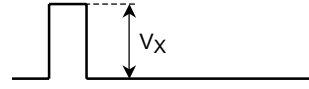
Note No.	Parameter	Test Condition								Test Method (unless otherwise specified, $V_{CC} = 9\text{ V}$ , $T_a = 25 \pm 3^\circ\text{C}$ , data = preset values)
		SW Mode								
		SW5	SW6	SW7	SW8	SW10	SW11	SW17	SW24	
23	Horizontal EHT compensation (H-EHT compensation) DC change amount	OFF	B	ON	OFF	B	ON	A	A	<p>(1) Input vertical trigger pulse to pin <math>V_{IN}</math>. Pulse level (<math>V_T</math>) = 3.0 V</p> <p>(2) Set EW PARABOLA (sub-address: 0A) to center (data: 20).</p> <p>(3) Apply external power supply (DC voltage = 1 V) to pin 3 (EHT IN).</p> <p>(4) Set H-EHT COMPENSATION (sub-address: 03) to minimum (data: 80) and measure Pin 10 (EW FD) amplitude <math>V_{HC}</math> (80).</p> <p>(5) Set H-EHT COMPENSATION (sub-address: 03) to maximum (data: 87) and measure Pin 10 (EW FD) amplitude <math>V_{HC}</math> (87).</p> <p>(6) Calculate change amount <math>V_{HC}</math> using the following formula.</p> <div style="text-align: center;">  <p>Pin 10 (EW FD) waveform</p> </div> <p><math>V_{HC} = V_{HC} (87) - V_{HC} (80)</math></p>

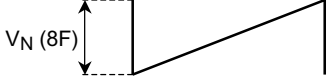
Note No.	Parameter	Test Condition								Test Method (unless otherwise specified, V <sub>CC</sub> = 9 V, Ta = 25 ± 3°C, data = preset values)
		SW Mode								
		SW5	SW6	SW7	SW8	SW10	SW11	SW17	SW24	
24	Parabola amplitude EHT compensation	OFF	B	ON	OFF	B	ON	A	A	(1) Input vertical trigger pulse to pin V <sub>IN</sub> . Pulse level (VT) = 3.0 V (2) Apply external power supply V <sub>3</sub> to pin 3 (EHT IN). (3) Set EW PARABOLA (sub-address: 0A) to center (data: 20). (4) Set external power supply V <sub>3</sub> to 7 V and measure Pin 10 (EW FD) amplitude EHT (7). (5) Set external power supply V <sub>3</sub> to 1 V and measure Pin 10 (EW FD) amplitude EHT (1). (6) Calculate change amount EHT using the following formula. $\text{EHT} = \frac{\text{EHT (7)} - \text{EHT (1)}}{\text{EHT (7)}} \times 100$
25	AGC operating current	OFF	B	ON	OFF	B	ON	A	B	(1) Input vertical trigger pulse to pin V <sub>IN</sub> . Pulse level (VT) = 3.0 V (2) When V AGC (sub-address: 09) is switched, set data to 00, 40, 80, and C0 and measure the following. (3) Monitor pin 24 (AGC FILTER) and measure pulse levels V <sub>X</sub> (00), V <sub>X</sub> (40), V <sub>X</sub> (80), and V <sub>X</sub> (C0) as shown in the figure below. (4) Calculate output currents (I <sub>X</sub> (00), I <sub>X</sub> (40), I <sub>X</sub> (80), I <sub>X</sub> (C0) using the following formula. <div style="text-align: center;">  <p>Pin 24 (AGC FILTER) waveform</p> </div> $I_X (**) = \frac{V_X (**)}{200 \Omega}$

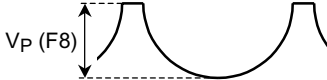
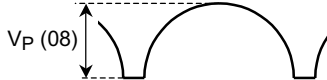
Note No.	Parameter	Test Condition								Test Method (unless otherwise specified, $V_{CC} = 9\text{ V}$ , $T_a = 25 \pm 3^\circ\text{C}$ , data = preset values)
		SW Mode								
		SW5	SW6	SW7	SW8	SW10	SW11	SW17	SW24	
26	Sawtooth correction (cent saw) maximum amplitude	OFF	B	ON	OFF	B	ON	A	A	<p>(1) Input vertical trigger pulse to pin <math>V_{IN}</math>. Pulse level (VT) = 3.0 V</p> <p>(2) Set CENTER SAW (sub-address: 10) to maximum (data: 8F) and measure pin 19 (CENT OUT) amplitude <math>V_N</math> (8F).</p> <p>(3) Set CENTER SAW (sub-address: 10) to minimum (data: 80) and measure pin 19 (CENT OUT) amplitude <math>V_N</math> (80).</p> <div style="display: flex; justify-content: space-around; align-items: center;"> <div style="text-align: center;">  <p>Pin 19 (CENT OUT) waveform</p> </div> <div style="text-align: center;">  <p>Pin 19 (CENT OUT) waveform</p> </div> </div>
27	Parabola correction (cent par) maximum amplitude	OFF	B	ON	OFF	B	ON	A	A	<p>(1) Input vertical trigger pulse to pin <math>V_{IN}</math>. Pulse level (VT) = 3.0 V</p> <p>(2) Set CENTER PARABOLA (sub-address: 10) to maximum (data: F8) and measure pin 19 (CENT OUT) amplitude <math>V_P</math> (F8).</p> <p>(3) Set CENTER PARABOLA (sub-address: 10) to minimum (data: 08) and measure pin 19 (CENT OUT) amplitude <math>V_P</math> (08).</p> <div style="display: flex; justify-content: space-around; align-items: center;"> <div style="text-align: center;">  <p>Pin 19 (CENT OUT) waveform</p> </div> <div style="text-align: center;">  <p>Pin 19 (CENT OUT) waveform</p> </div> </div>

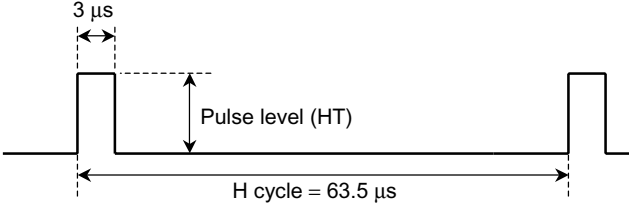
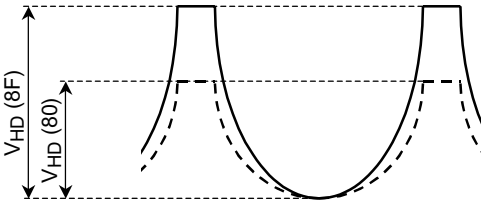
Note No.	Parameter	Test Condition								Test Method (unless otherwise specified, $V_{CC} = 9\text{ V}$ , $T_a = 25 \pm 3^\circ\text{C}$ , data = preset values)
		SW Mode								
		SW5	SW6	SW7	SW8	SW10	SW11	SW17	SW24	
28	Horizontal DF amplitude adjustment (H DF amp)	OFF	B	ON	OFF	B	ON	A	A	<p>(1) Input horizontal trigger pulse (figure below) to pin 12 (FBP IN). Pulse level (HT) = 4.0 V</p>  <p>(2) Set H-DF CURVE (sub-address: 08) to maximum (data: F0).</p> <p>(3) Set H-DF AMPLITUDE (sub-address: 07) to minimum (data: 80) and measure pin 16 (H-DF OUT) amplitude <math>V_{HD}</math> (80).</p> <p>(4) Set H-DF AMPLITUDE (sub-address: 07) to center (data: 88) and measure pin 16 (H-DF OUT) amplitude <math>V_{HD}</math> (88).</p> <p>(5) Set H-DF AMPLITUDE (sub-address: 07) to maximum (data: 8F) and measure pin 16 (H-DF OUT) amplitude <math>V_{HD}</math> (8F).</p> <p>(6) Calculate change amounts <math>V_{HDP}</math> and <math>V_{HDN}</math> using the following formulas.</p>  <p style="text-align: center;">Pin 16 (H-DF OUT) waveform</p> $V_{HDP} = \frac{V_{HD} (80) - V_{HD} (88)}{V_{HD} (88)} \times 100$ $V_{HDN} = \frac{V_{HD} (8F) - V_{HD} (88)}{V_{HD} (88)} \times 100$

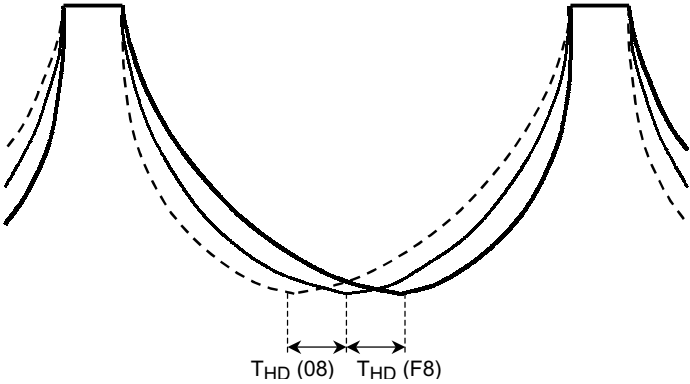
Note No.	Parameter	Test Condition								Test Method (unless otherwise specified, $V_{CC} = 9\text{ V}$ , $T_a = 25 \pm 3^\circ\text{C}$ , data = preset values)
		SW Mode								
		SW5	SW6	SW7	SW8	SW10	SW11	SW17	SW24	
29	Horizontal DF phase adjustment (H DF phase)	OFF	B	ON	OFF	B	ON	A	A	<p>(1) Input horizontal trigger pulse (figure below) to pin 12 (FBP IN). Pulse level (HT) = 4.0 V</p> <p>(2) Set H-DF CURVE (sub-address: 08) to maximum (data: F0).</p> <p>(3) Set H-DF PHASE (sub-address: 07) to minimum (data: 08) and measure pin 16 (H-DF OUT) phase <math>T_{HD}</math> (08).</p> <p>(4) Set H-DF PHASE (sub-address: 07) to maximum (data: F8) and measure pin 16 (H-DF OUT) phase <math>T_{HD}</math> (F8).</p> <p>(5) Calculate change amount <math>T_{HD}</math> using the following formula.</p>  <p style="text-align: center;">Pin 16 (H-DF OUT) waveform</p> $T_{HD} = T_{HD} (08) + T_{HD} (F8)$

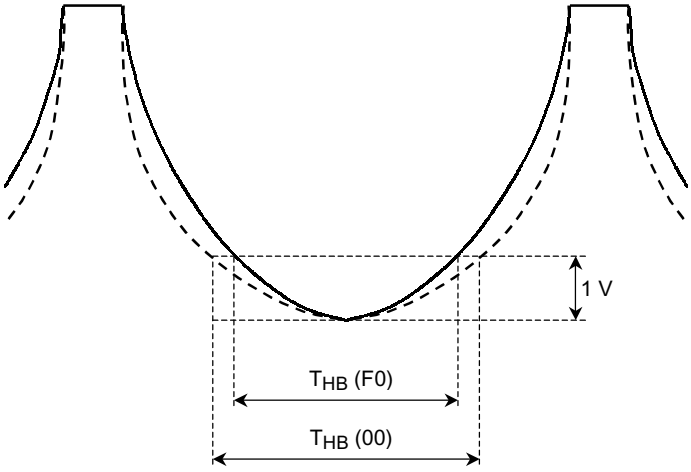
Note No.	Parameter	Test Condition								Test Method (unless otherwise specified, V <sub>CC</sub> = 9 V, Ta = 25 ± 3°C, data = preset values)
		SW Mode								
		SW5	SW6	SW7	SW8	SW10	SW11	SW17	SW24	
30	Horizontal DF bathtub (H DF curve) adjustment	OFF	B	ON	OFF	B	ON	A	A	<p>(1) Input horizontal trigger pulse (figure below) to pin 12 (FBP IN). Pulse level (HT) = 4.0 V</p> <p>(2) Set H-DF AMPLITUDE (sub-address: 07) to maximum (data: 8F).</p> <p>(3) Set H-DF CURVE (sub-address: 08) to minimum (data: 00) and measure pin 16 (H-DF OUT) phase T<sub>HB</sub> (00).</p> <p>(4) Set H-DF CURVE (sub-address: 08) to maximum (data: F0) and measure pin 16 (H-DF OUT) phase T<sub>HB</sub> (F0).</p> <p>(5) Calculate change amount T<sub>HB</sub> using the following formula.</p>  <p style="text-align: center;">Pin 16 (H-DF OUT) waveform</p> $T_{HB} = \frac{T_{HB} (00) - T_{HB} (F0)}{2}$

Note No.	Parameter	Test Condition								Test Method (unless otherwise specified, $V_{CC} = 9\text{ V}$ , $T_a = 25 \pm 3^\circ\text{C}$ , data = preset values)
		SW Mode								
		SW5	SW6	SW7	SW8	SW10	SW11	SW17	SW24	
31	Vertical DF amplitude adjustment (V DF amp)	OFF	B	ON	OFF	B	ON	A	A	<p>(1) Input vertical trigger pulse to pin <math>V_{IN}</math>. Pulse level (<math>V_T</math>) = 3.0 V</p> <p>(2) Set V-DF AMPLITUDE (sub-address: 06) to minimum (data: 80) and measure pin 18 (V-DF OUT) amplitude <math>V_{VD}</math> (80).</p> <p>(3) Set V-DF AMPLITUDE (sub-address: 06) to center (data: 88) and measure pin 18 (V-DF OUT) amplitude <math>V_{VD}</math> (88).</p> <p>(4) Set V-DF AMPLITUDE (sub-address: 06) to maximum (data: 8F) and measure pin 18 (V-DF OUT) amplitude <math>V_{VD}</math> (8F).</p> <p>(5) Calculate change amounts <math>V_{VDP}</math> and <math>V_{VDN}</math> using the following formulas.</p> <div style="text-align: center;"> <p>Pin 18 (V-DF OUT) waveform</p> </div> $V_{VDP} = \frac{V_{VD} (80) - V_{VD} (88)}{V_{VD} (88)} \times 100$ $V_{VDN} = \frac{V_{VD} (8F) - V_{VD} (88)}{V_{VD} (88)} \times 100$

Note No.	Parameter	Test Condition								Test Method (unless otherwise specified, $V_{CC} = 9\text{ V}$ , $T_a = 25 \pm 3^\circ\text{C}$ , data = preset values)
		SW Mode								
		SW5	SW6	SW7	SW8	SW10	SW11	SW17	SW24	
32	Vertical DF phase adjustment (V DF phase)	OFF	B	ON	OFF	B	ON	A	A	(1) Input vertical trigger pulse to pin $V_{IN}$ . Pulse level ( $V_T$ ) = 3.0 V (2) Set V-DF PHASE (sub-address: 06) to minimum (data: 08) and measure pin 18 (V-DF OUT) phase $T_{VD}$ (08). (3) Set V-DF PHASE (sub-address: 06) to maximum (data: F8) and measure pin 18 (V-DF OUT) phase $T_{VD}$ (F8). (4) Calculate change amount $T_{VD}$ using the following formula. <p style="text-align: center;">Pin 18 (V-DF OUT) waveform</p> $T_{VD} = T_{VD} (08) + T_{VD} (F8)$
33	LVP detection voltage	OFF	B	ON	OFF	B	ON	B	A	(1) Connect external supply voltage $V_7$ to TP17 (LVP). (2) Decrease external supply voltage $V_7$ from 9 V. When D5 data in Read mode changes from 0 to 1, measure TP17 voltage $V_{LVP}$ .
34	Vertical guard detection voltage	OFF	C	ON	OFF	B	ON	A	A	(1) Connect external supply voltage $V_6$ to TP6 (V NF). (2) Switch to VD (sub-address: 00) to AC-Coupling mode (data: 81). (3) Increase external supply voltage $V_6$ from 5.5 V. When D3 data in Read mode changes from 0 to 1, measure TP6 voltage $V_{VGH}$ . (4) Decrease external supply voltage $V_6$ from 5.5 V. When D3 data in Read mode changes from 0 to 1, measure TP6 voltage $V_{VGL}$ .

Note No.	Parameter	Test Condition								Test Method (unless otherwise specified, V <sub>CC</sub> = 9 V, Ta = 25 ± 3°C, data = preset values)
		SW Mode								
		SW5	SW6	SW7	SW8	SW10	SW11	SW17	SW24	
35	Vertical guard detection output current (BLK-OUT output current)	OFF	C	ON	OFF	B	ON	A	A	(1) Connect external supply voltage V <sub>6</sub> = 8 V to TP6 (V NF). (2) Measure pin 20 (BLK OUT) voltage V <sub>20</sub> and calculate output current (I <sub>20</sub> ) using the following formula.  $I_{20} = \frac{V_{20}}{10 \text{ k}\Omega}$
36	Vertical centering DAC output voltage 1 (V centering)	OFF	B	ON	OFF	B	ON	A	A	(1) Set VD (sub-address: 00) to AC-Coupling mode (data: 81). (2) Set V CENTERING (sub-address: 05) to minimum (data: 00) and measure pin 2 (CENTER DAC) voltage V <sub>CA</sub> (00). (3) Set V CENTERING (sub-address: 05) to maximum (data: FE) and measure pin 2 (CENTER DAC) voltage V <sub>CA</sub> (FE). (4) Calculate change amount per bit V <sub>CA</sub> using the following formula.  $V_{CA} = (V_{CA} \text{ (FE)} - V_{CA} \text{ (00)})/127$
37	Vertical centering DAC output voltage 2 (V shift)	OFF	A	OFF	OFF	B	ON	A	A	(1) Set VD (sub-address: 00) to DC-Coupling mode (data: 80). (2) Set V SHIFT (sub-address: 01) to minimum (data: 80) and measure pin 2 (CENTER DAC) voltage V <sub>CD</sub> (80). (3) Set V SHIFT (sub-address: 01) to maximum (data: 83) and measure pin 2 (CENTER DAC) voltage V <sub>CD</sub> (83). (4) Calculate change amount per bit V <sub>CD</sub> using the following formula.  $V_{CD} = (V_{CD} \text{ (80)} - V_{CD} \text{ (83)})/3$
38	Vertical centering change amount in V STOP mode	ON	A	OFF	OFF	B	ON	A	A	(1) Set VD (sub-address: 00) to DC-Coupling mode (data: 80). (2) Set to V STOP (sub-address: 0B, data: 81). (3) Set V CENTERING (sub-address: 05) to minimum (data: 00) and measure Pin 6 (V NF) voltage V <sub>γ</sub> (00). (4) Set V CENTERING (sub-address: 05) to center (data: 80) and measure Pin 6 (V NF) voltage V <sub>γ</sub> (80). (5) Set V CENTERING (sub-address: 05) to minimum (data: FE) and measure Pin 6 (V NF) voltage V <sub>γ</sub> (FE).

Note No.	Parameter	Test Condition								Test Method (unless otherwise specified, $V_{CC} = 9\text{ V}$ , $T_a = 25 \pm 3^\circ\text{C}$ , data = preset values)
		SW Mode								
		SW5	SW6	SW7	SW8	SW10	SW11	SW17	SW24	
39	Vertical NF signal amplitude at DC coupling	ON	A	OFF	OFF	B	ON	A	A	(1) Input vertical trigger pulse to pin $V_{IN}$ . Pulse level ( $V_T$ ) = 3.0 V (2) Set VD (sub-address: 00) to DC-Coupling mode (data: 80). (3) Measure vertical Pin 6 (V NF) sawtooth width $V_{DFB}$ .
										<p>Pin 6 (V NF) waveform</p> <p><math>V_{DFB}</math></p>
40	Vertical NF center voltage at DC coupling	ON	A	OFF	OFF	B	ON	A	A	(1) Input vertical trigger pulse to pin $V_{IN}$ . Pulse level ( $V_T$ ) = 3.0 V (2) Set VD (sub-address: 00) to DC-Coupling mode (data: 80). (3) Measure center voltage $V_C$ as shown in the figure below.
										<p>Pin 6 (V NF) waveform</p> <p><math>V_C</math></p> <p>10 ms</p> <p>10 ms</p>

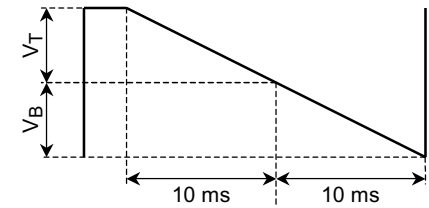
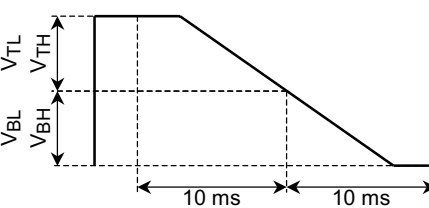
Note No.	Parameter	Test Condition								Test Method (unless otherwise specified, $V_{CC} = 9\text{ V}$ , $T_a = 25 \pm 3^\circ\text{C}$ , data = preset values)
		SW Mode								
		SW5	SW6	SW7	SW8	SW10	SW11	SW17	SW24	
41	Vertical ramp cut level	ON	A	OFF	OFF	B	ON	A	A	<p>(1) Input vertical trigger pulse to pin <math>V_{IN}</math>. Pulse level (<math>V_T</math>) = 3.0 V</p> <p>(2) Set VD (sub-address: 00) to DC-Coupling mode (data: 80).</p> <p>(3) Set V INTEGRAL CORRECTION (sub-address: 08) to center (data: 8F).</p> <p>(4) Set V S CORRECTION (sub-address: 09) to center (data: A0).</p> <p>(5) Measure amplitudes <math>V_T</math> and <math>V_B</math> as shown in the figure below.</p>  <p>(6) Set V-RAMP to minimum and measure amplitudes <math>V_{TL}</math> and <math>V_{BL}</math>. Sub-address 04 data: 81 Sub-address 05 data: 80</p> <p>(7) Set V-RAMP to maximum and measure amplitudes <math>V_{TH}</math> and <math>V_{BH}</math>. Sub-address 04 data: 87 Sub-address 05 data: 81</p>  <p>(8) Calculate cut levels using the following formulas.</p> $V_{CHL} = \frac{V_T - V_{TL}}{V_T} \times 100, \quad V_{CHH} = \frac{V_T - V_{TH}}{V_T} \times 100$ $V_{CCL} = \frac{V_B - V_{BL}}{V_B} \times 100, \quad V_{CLH} = \frac{V_B - V_{BH}}{V_B} \times 100$

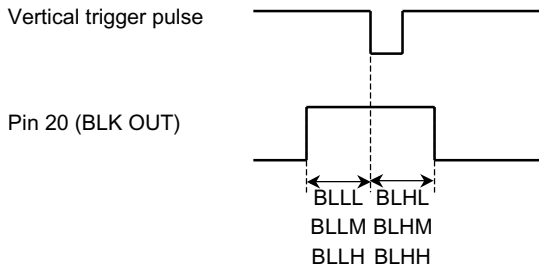
Note No.	Parameter	Test Condition								Test Method (unless otherwise specified, $V_{CC} = 9\text{ V}$ , $T_a = 25 \pm 3^\circ\text{C}$ , data = preset values)
		SW Mode								
		SW5	SW6	SW7	SW8	SW10	SW11	SW17	SW24	
42	Analog blanking phase	ON	A	OFF	OFF	B	ON	A	A	<p>(1) Input vertical trigger pulse to pin <math>V_{IN}</math>. Pulse level (<math>V_T</math>) = 3.0 V</p> <p>(2) Set VD (sub-address: 00) to DC-Coupling mode (data: 80).</p> <p>(3) Set V INTEGRAL CORRECTION (sub-address: 08) to center (data: 8F).</p> <p>(4) Set V S CORRECTION (sub-address: 09) to center (data: A0).</p> <p>(5) AS shown in the figure below, measure analog blanking phase in relation to pin 21 (<math>V_{IN}</math>) under the following conditions.</p> <p>(6) Set ANALOG V-BLK STOP PHASE (sub-address: 03) to minimum (data: 00) and measure blanking phase BLHL.</p> <p>(7) Set ANALOG V-BLK STOP PHASE (sub-address: 03) to center (data: 80) and measure blanking phase BLHM.</p> <p>(8) Set ANALOG V-BLK STOP PHASE (sub-address: 03) to maximum (data: F8) and measure blanking phase BLHH.</p> <p>(9) Set ANALOG V-BLK START PHASE (sub-address: 04) to minimum (data: 00) and measure blanking phase BLLL.</p> <p>(10) Set ANALOG V-BLK START PHASE (sub-address: 04) to center (data: 80) and measure blanking phase BLLM.</p> <p>(11) Set ANALOG V-BLK START PHASE (sub-address: 04) to maximum (data: F8) and measure blanking phase BLLH.</p> <p>Vertical trigger pulse </p>

Note No.	Parameter	Test Condition								Test Method (unless otherwise specified, $V_{CC} = 9\text{ V}$ , $T_a = 25 \pm 3^\circ\text{C}$ , data = preset values)
		SW Mode								
		SW5	SW6	SW7	SW8	SW10	SW11	SW17	SW24	
43	Parabola amplitude adjustment (EW parabola) change amount at PWM	OFF	B	ON	ON	A	OFF	A	A	(1) Input vertical trigger pulse to pin $V_{IN}$ . Pulse level ( $V_T$ ) = 3.0 V (2) Set PICTURE WIDTH (sub-address: 01) to maximum (data: 8C). (3) Apply external power supply (DC voltage = 7 V) to pin 3 (EHT IN). (4) Set EW PARABOLA (sub-address: 0A) to minimum (data: 00) and measure Pin 10 (EW FD) amplitude $V_{PP}$ (00). (5) Set EW PARABOLA (sub-address: 0A) to center (data: 20) and measure Pin 10 (EW FD) amplitude $V_{PP}$ (20). (6) Set EW PARABOLA (sub-address: 0A) to maximum (data: 3F) and measure Pin 10 (EW FD) amplitude $V_{PP}$ (3F). (7) Calculate change amount $V_{PP}$ using the following formula.
<p style="text-align: center;">Pin 10 (EW FD) waveform</p> $V_{PP} = V_{PP} (3F) - V_{PP} (00)$										

Test circuit

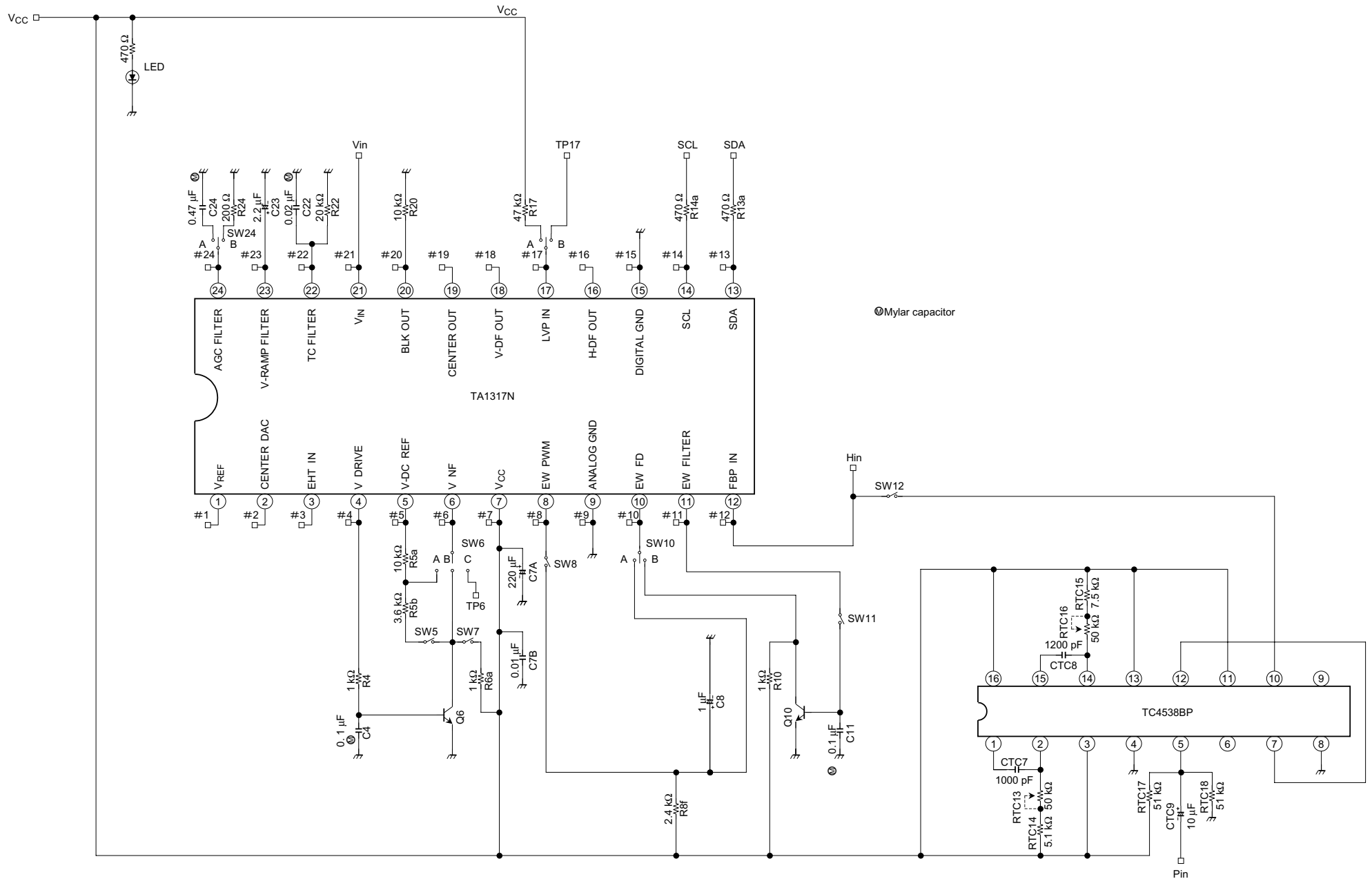

## Package Dimensions

SDIP24-P-300-1.78

Unit : mm

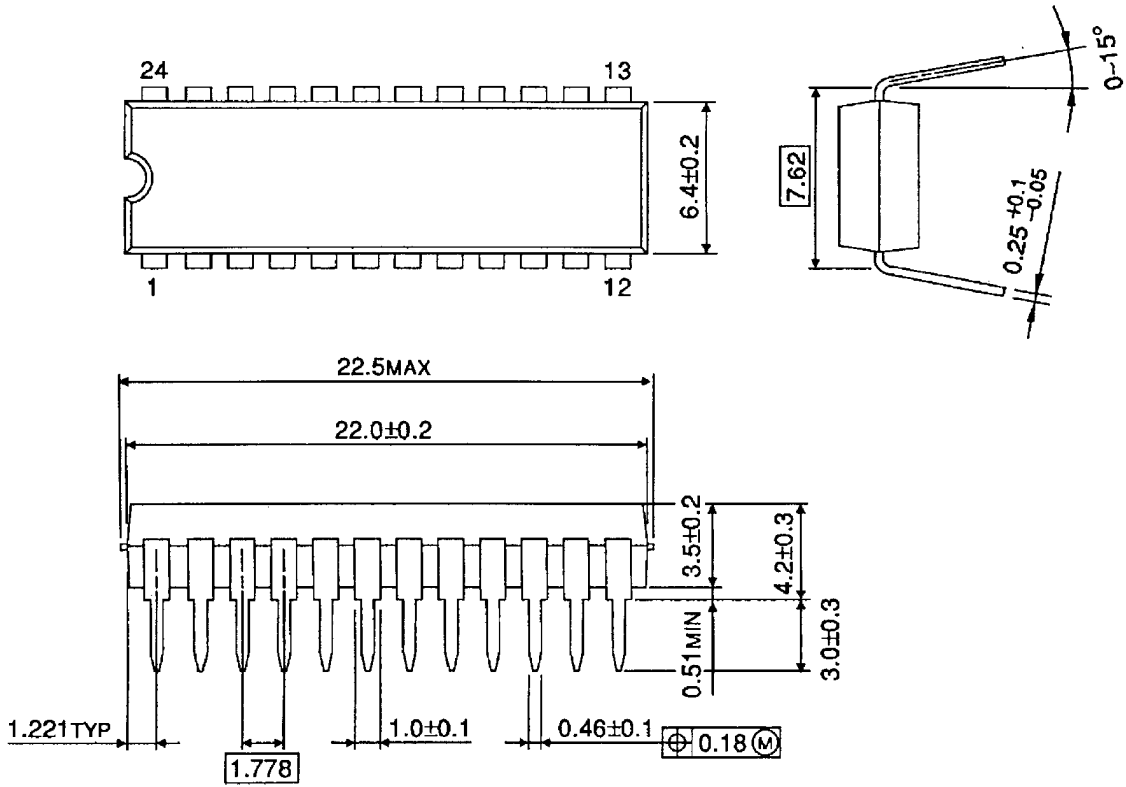

Weight: 1.22 g (typ.)