

**PRODUCT NUMBER: 122-11-964-41-001000**

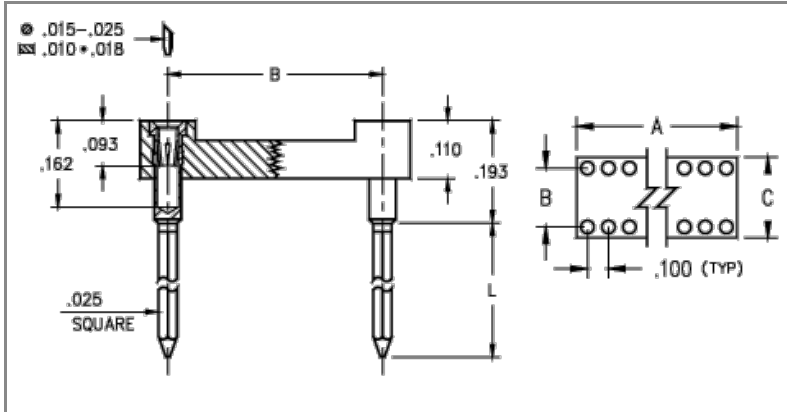

**DESCRIPTION**

- DIP Dual In Line Socket
- Wire-Wrap Tail
- Frame Type:** Open Frame
- Pitch:** .100" (2,540mm)
- Clip Grid:** 41
- Pin Window Pattern** 001
- Plating Code:** 11
- Shell:** 10 μ" Gold over 100 μ" Nickel
- Inner Contact:** 10 μ" Gold over 50 μ" Nickel
- Insulator Pin Clip Type:** 000
- Packaging:** Packaged in Tubes
- Insulator Information:**  
PCT High Temperature

# Pins	Qty Tube	ROHS Compliant	A Dim	B Dim	C Dim	L Dim
64	6		3.200" (81,280mm)	.900" (22,860mm)	1" (25,400mm)	.370" (9,398mm)

**CONTACT:**

**#30 CONTACT**  
 FOR .015"-.025" DIAMETER PINS (δ = .005)  
 4-FINGER, GROUP C (See page 248)

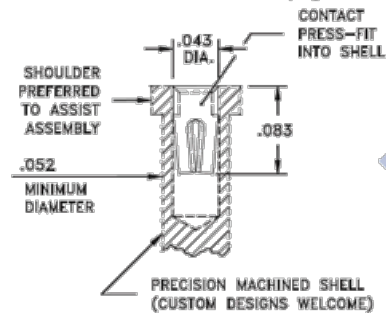

**CONTACT MATERIAL**  
 BERYLLIUM COPPER  
 Alloy 172,  
 Heat Treated

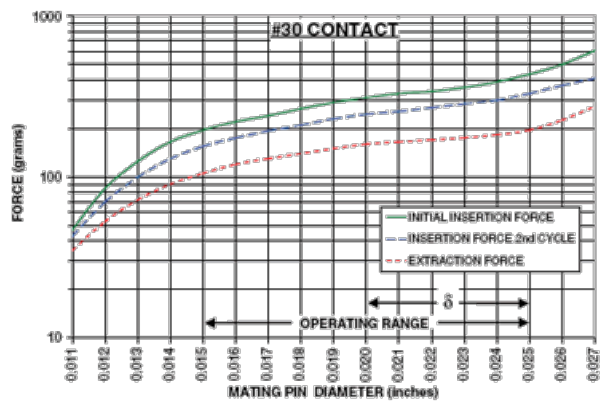

<b>Pin Diameter Range</b>	.015"-.025" (0,381-0,635mm)		
<b>Material</b>	Beryllium Copper	<b>Current Rating (amps)</b>	3.00
<b>Fingers</b>	4	<b>Compliance</b>	.005" (0,127mm)
<b>Length</b>	.080" (2,032mm)	<b>Group Code</b>	C

## CONTACT MATERIAL:

### BERYLLIUM COPPER ALLOY 172 (UNS C17200) per ASTM B 194

Properties of BERYLLIUM COPPER:

- Chemical composition: Cu 98.1%, Be 1.9%
- Hardness: 36-43 Rockwell C
- Density: .298 lbs/in<sup>3</sup>
- Electrical Conductivity: 22% IACS\*
- Resistance: 10 mΩ Max
- Operating Temperature: -55°C/+125°C
- Melting point: 980°C/865°C (liquidus/solidus)
- Stress Relaxation†: 96% of stress remains after 1,000 hours @ 100 °C; 70% of stress remains after 1,000 hours @ 200 °C

\*International Annealed Copper Standard, i.e. as a % of pure copper.

†Since BeCu loses its spring properties over time at high temperatures; it is rated for continuous use up to 150°C. For applications up to 300°C, Mill-Max offers other materials. [Contact Tech Support](#) for more info.

## LOOSE PIN/RECEPTACLE USED:

0089 (Brass Alloy)

### BRASS ALLOY 360 per ASTM B 16, or 385 per ASTM B455

Properties of BRASS ALLOY 360 ASTM B 16:

- Chemical composition: Cu 63% (max), Pb 3.7% (max)†, Fe .35% (max), Zn remainder
- Temper as machined: H02/H04
- Yield Strength: 25-45 ksi
- Tensile strength: 57-80 ksi
- Hardness as machined: 80-90 Rockwell B
- Electrical conductivity: 26% IACS\*
- Melting point: 1000°C/840°C (liquidus/solidus)

Properties of BRASS ALLOY 385 ASTM B 455:

- Chemical composition: Cu 60% (max), Pb 3.5% (max)†, Fe .35% (max), Zn remainder
- Temper as machined: H02/H04
- Yield Strength: 16 ksi(min)
- Tensile strength: 48 ksi(min)
- Hardness as machined: 80-90 Rockwell B
- Electrical conductivity: 28% IACS\*
- Melting point: 1000°C/840°C (liquidus/solidus)

After machining, brass parts are often annealed (softened) for subsequent bending, swaging or crimping. A partial anneal down to 60±10 RB is recommended for 90° bends, a full anneal down to 35±15 RB is recommended for pins or terminals that are swaged (riveted) to a circuit board or crimped to a wire.

**Note:** Plated Brass parts need a barrier plate to prevent zinc diffusion, 50µ" min. nickel or 100µ" min. copper is recommended by ASTM B 545 and 579. ASTM B 488 also recommends a 50µ" min. nickel barrier plate beneath gold to prevent copper diffusion inherent with all copper alloy products.

†RoHS-2 directive 2011/65/EU, exemption 6c allows up to 4% lead as an alloy agent in copper.

\*International Annealed Copper Standard, i.e. as a % of pure copper.

## INSULATOR MATERIAL:

### PCT Polyester (Injection Molded)

Properties:

- Polyester {30% glass filled}, High Temp., (black). Flammability rating UL 94 V-0

- Rated voltage: 100 VRMS/150 VDC
- Insulation resistance: 10,000 Megaohms min.
- Material Heat Deflection Temp (per ASTM D 648): 529°F (276°C) @ 66 psi
- Dielectric strength: 1000 VRMS min. (700 VRMS min. for series 117 Shrink DIP)

Note: Materials with HDT above 446°F (230°C) are considered suitable for “eutectic” reflow soldering. For “lead-free” reflow soldering, choose materials with an HDT above 500°F (260°C). PCT is the standard plastic used with RoHS “lead-free” plated pins.

### **STANDARD TOLERANCES ON PCB TERMINAL PINS & RECEPTACLES**

Diameters +/- .002"

Lengths +/- .005"

Angles +/- 2°

### **STANDARD TOLERANCES ON SPRING-LOADED PINS**

Diameters +/- .002"

Lengths +/- .006"

Angles +/- 2°

### **ADDITIONAL NOTES & SPECIFICATIONS**

In the interest of improved design, quality and performance, Mill-Max reserves the right to make changes in its specifications without prior notice. Specifications and tolerances are provided wherever possible. The tolerance on dimensions of critical to function features is typically held tighter than the stated standard tolerances, such as press-fits, holes and lengths affecting the coplanarity of SMT products. Due to the wide variety of interconnects Mill-Max offers, the specific tolerances vary from product to product. If you need information regarding the tolerance of a particular part, please contact Technical Services.

---

 © 2021 Mill-Max Mfg. Corp.  
190 Pine Hollow Rd, Oyster Bay, NY 11771, USA  
Phone: 516.922.6000