

# WL50F-2PBQ

## Work Light – Spotlight

### Features

- ON/OFF switch
- Operating voltage 12...30 VDC
- Protection class IP67
- Color: White
- M12 x 1 connector

### Wiring diagram

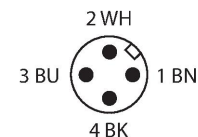
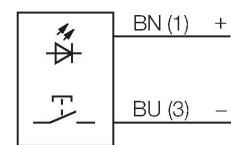

### Functional principle

This high-intensity work lights are designed specifically for the lighting of enclosures and work surfaces. The power consumption is less than 3 W at an efficiency of 72 lumen per watt. Depending on the design, the lights can be mounted on the wall or elsewhere with the supplied 30 mm thread. Devices with integrated on/off switch are also available. After connecting the power line, the device must be switched on.

### Diagram

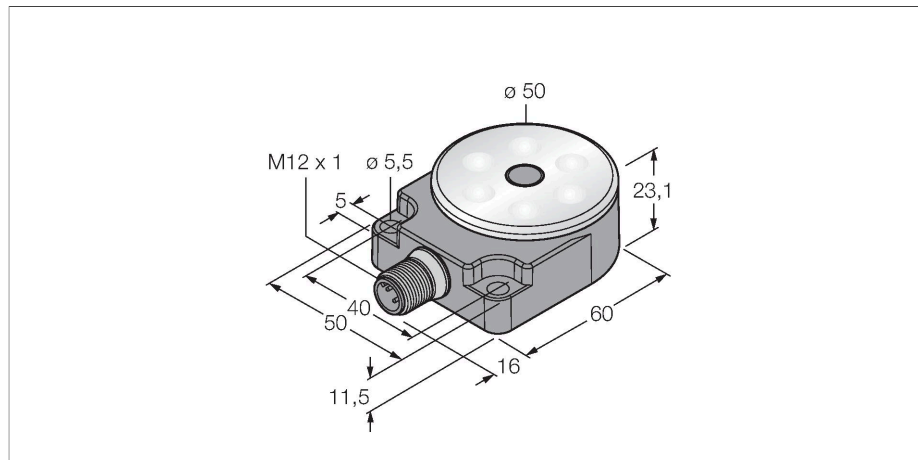
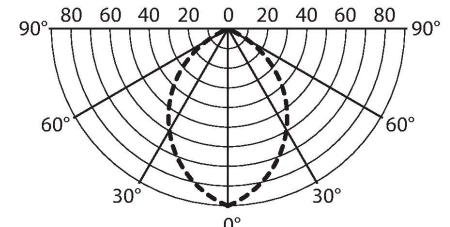

### Technical data

Type	WL50F-2PBQ
ID no.	3085373
<b>Signal and display data</b>	
Purpose	LED work light
Function	Spotlight
Light type	White
Color temperature	6000...+7000 K
Luminous flux lumen	185 lm
LED service life (L70)	50000 h
Dimmable	no
Features of color 1	White, Permanently on, 185 lm
<b>Electrical data</b>	
Operating voltage	12...30 VDC
DC rated operational current	≤ 110 mA
Input power	2.8 W
<b>Mechanical data</b>	
Cascadable	no
Design	Rectangular, WL50-2
Dimensions	76 x 50 x 23.1 mm
Housing material	Plastic, PC, Black
Window material	Polycarbonate, clear
Electrical connection	Connectors, M12 x 1, PVC
Number of cores	4
Ambient temperature	-40...+50 °C
Protection class	IP67

Technical data

Tests/approvals

Approvals CE, UL

Accessories

SMB30A

3032723

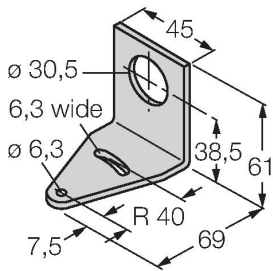

Mounting bracket, rectangular, stainless steel, for sensors with 30mm thread

SMB30SC

3052521

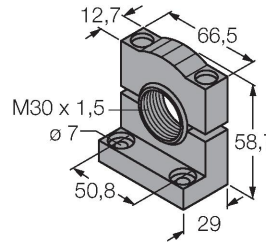

Mounting bracket, PBT black, for sensors with 30 mm thread, rotatable

SMB30MM

3027162

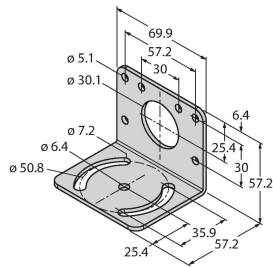

Mounting bracket, rectangular, stainless steel, for sensors with 30 mm thread, wide holes for accurate alignment

Accessories

Dimension drawing	Type	ID no.	
	RKC4.4T-2/TEL	6625013	Connection cable, female M12, straight, 4-pin, cable length: 2 m, sheath material: PVC, black; cULus approval; other cable lengths and qualities available, see <a href="http://www.turck.com">www.turck.com</a>
	WKC4.4T-2/TEL	6625025	Connection cable, female M12, angled, 4-pin, cable length: 2 m, sheath material: PVC, black; cULus approval; other cable lengths and qualities available, see <a href="http://www.turck.com">www.turck.com</a>