

## STRAIGHT FLANGE FEMALE RECEPTACLES WITH SOLDER POT

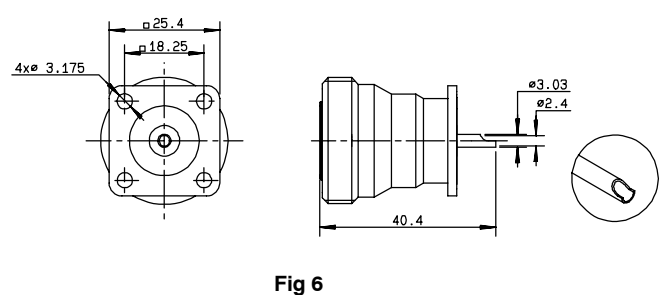
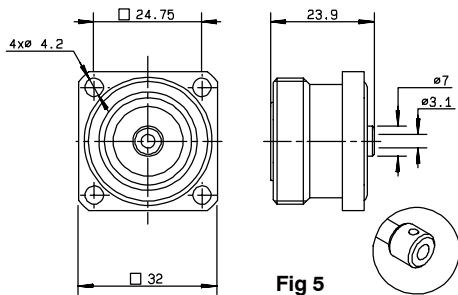
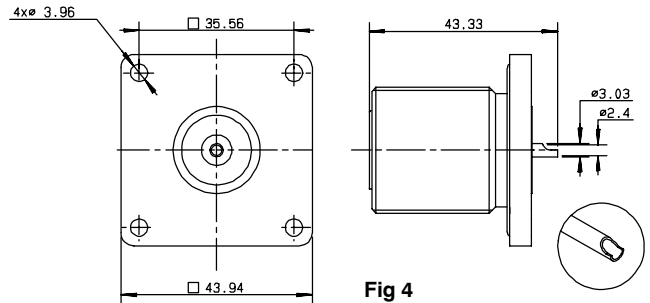
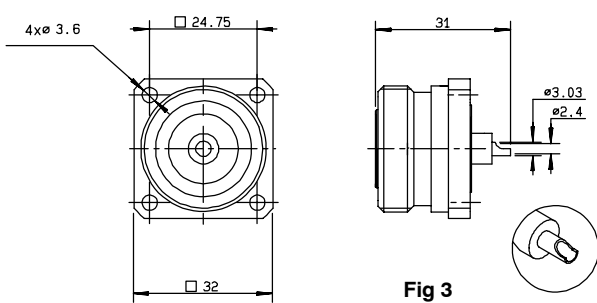
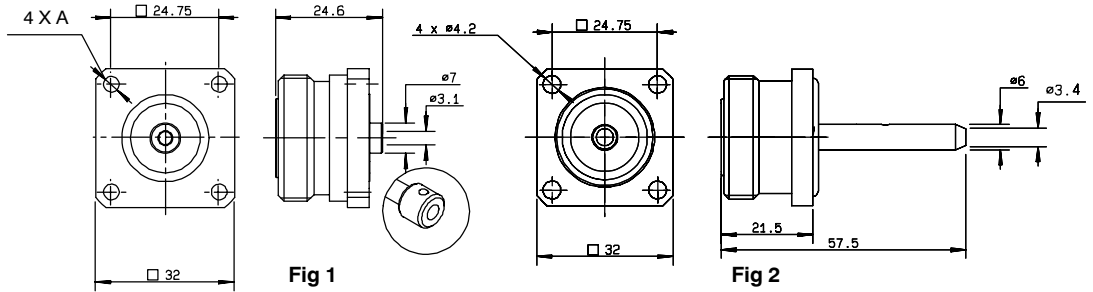

part number	capt. center cont.	fig.	dim.A	panel	finish	slotted outer contact	packaging	note
R185 403 407*	yes	1	4 x 3.6	P01	BBR	yes	20	removable contact
R185 403 420*	yes	1	4 x M3	P01	BBR	yes	20	
R185 403 430*	yes	2		P08	Silver	no	unit	panel seal
R185 404 100*	yes	3		P01	Silver	no	20	
R185 404 127*	yes	4		P03	BBR	no	unit	
R185 404 440*	yes	5		P04	Silver	no	20	
R185 407 020*	yes	6		P09	Silver	no	unit	N type flange

\* Manufactured upon request

Note : standard packaging = 20 pieces. For unit packaging, add "W" after the P/N.



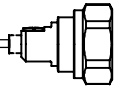

## STRAIGHT FLANGE FEMALE RECEPTACLES WITH SLOTTED CONTACT

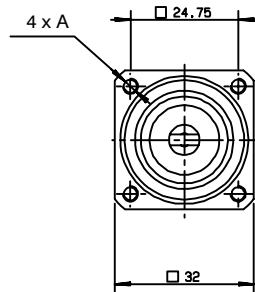
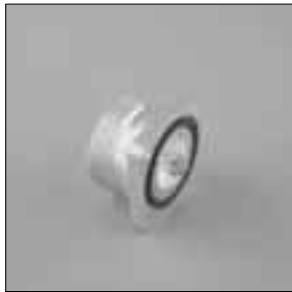

Fig 1

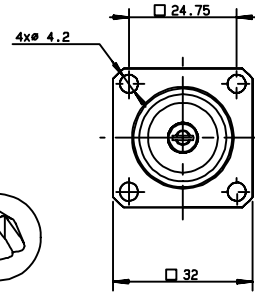
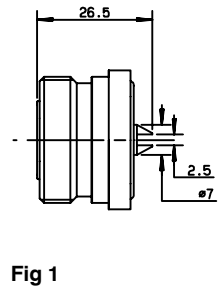
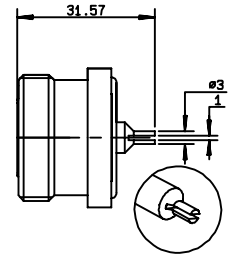

Fig 2



part number	capt. center cont.	fig.	dim. A	panel	finish	slotted outer contact	packaging	note
R185 404 200	yes	1	4 x 3.6	P05	Silver	no	20	panel seal
R185 404 230	yes	1	4 x M 3	P05	Silver	no	20	
R185 404 240*	yes	2	4 x 4.2	P04	Silver	no	20	

## STRAIGHT FEMALE RECEPTACLES WITH THREADED CONTACT

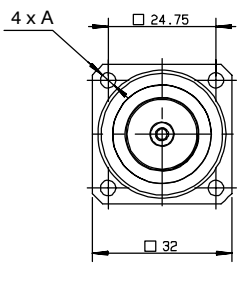

Fig 1

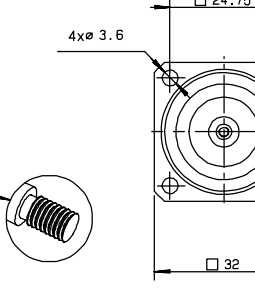
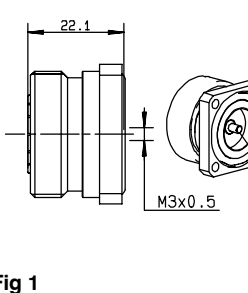

Fig 2

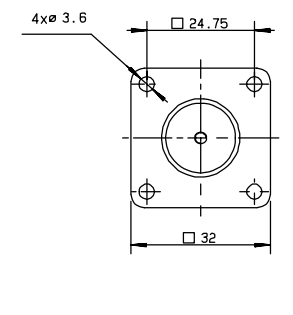
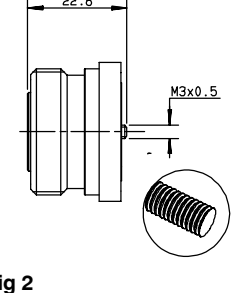

Fig 3

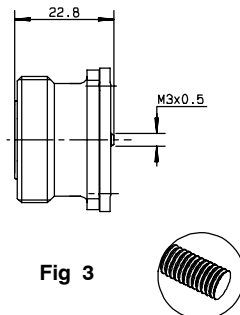

Fig 4

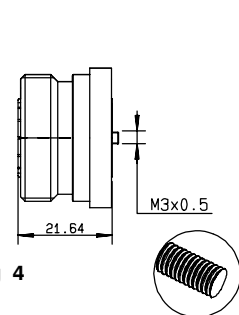
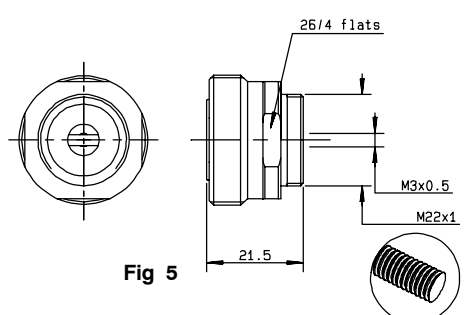

Fig 5



part number	capt. center cont.	fig.	Dim.A	panel	finish	slotted outer contact	packaging	note
R185 405 200	yes	1	4 x 3.5	P05	Silver	no	20	panel seal - flange mount
R185 405 230	yes	1	4 x M3	P05	Silver	no	20	
R185 405 248*	yes	1	4 x 3.5	P05	Tin	yes	20	
R185 405 250*	yes	2		P05	Silver	no	20	
R185 405 400*	yes	3		P05	Silver	no	20	flange mount
R185 406 020*	yes	4		P05	Silver	no	20	panel seal - flange mount
R185 406 030*	yes	4		P05	Silver	no	20	
R185 560 020*	yes	5			Silver	no	unit	bulkhead mount

• Manufactured upon request

Note : standard packaging = 20 pieces. For unit packaging, add "W" after the P/N.



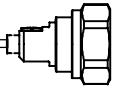

## STRAIGHT FLANGE FEMALE RECEPTACLES

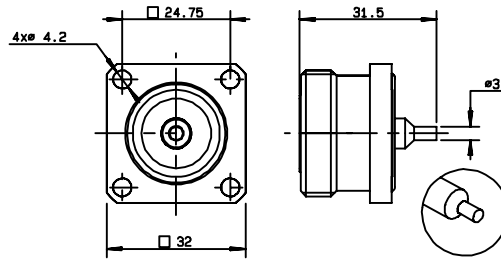

part number	capt. center cont.	panel	finish	slotted outer contact	packaging	note
<b>R185 404 300*</b>	yes	P04	Silver	no	20	panel seal - straight terminal

## STRAIGHT FLANGE MALE RECEPTACLES

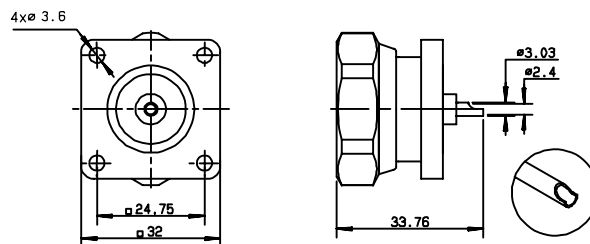

Fig 1

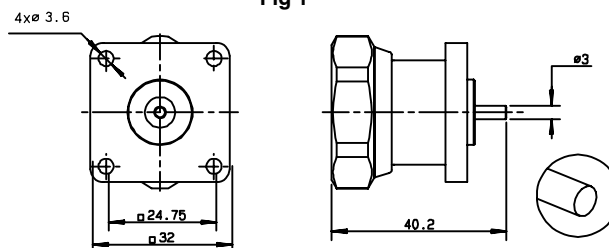

Fig 2

part number	fig	capt. center cont.	panel	finish	packaging	note
<b>R185 440 100*</b>	1	yes	P05	Silver	20	solder pot
<b>R185 441 200*</b>	2	yes	P06	Silver	20	straight terminal

\* Manufactured upon request

Note : standard packaging = 20 pieces. For unit packaging, add "W" after the P/N.