

# HMC-C078

## SUCCESSIVE DETECTION LOG VIDEO AMPLIFIER (SDLVA) MODULE w/ LIMITED RF OUTPUT, 2 - 20 GHz

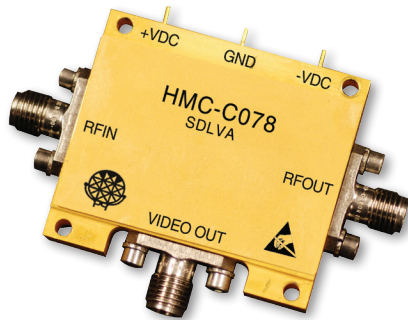

### Typical Applications

The HMC-C078 is ideal for:

- EW, ELINT & IFM Receivers
- DF Radar Systems
- ECM Systems
- Broadband Test & Measurement
- Power Measurement & Control Circuits
- Military & Space Applications

### Functional Diagram

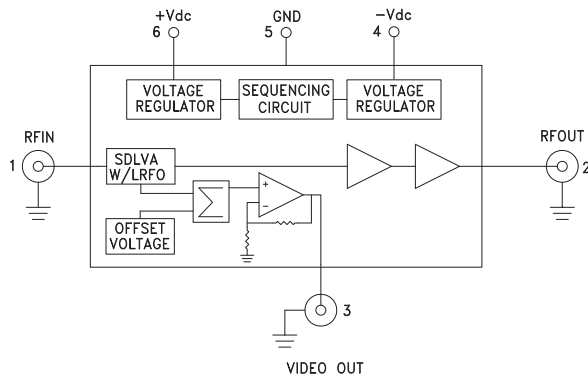

### Features

- Limited RF Output Power
- High Logging Range: 50 dB
- Output Frequency Flatness:  $\pm 1$  dB
- Internal Voltage Regulation
- Fast Rise/Fall Times: 5/8 ns
- Hermetically Sealed Module
- 55 °C to +85 °C Operating Temperature

### General Description

The HMC-C078 is a Successive Detection Log Video Amplifier (SDLVA) which operates from 2 to 20 GHz. The HMC-C078 provides a logging range of 50 dB.

This product comes standard with two female SMA field replaceable connectors but can also be used with blind mate SMP connectors or as a drop-in module. The package size measures 1.5 x 1.32 x 0.23" (38.10 x 33.53 x 5.84 mm) making it ideal for environmentally robust applications where space is limited. In addition to the video output signal, the HMC-C078 has a limited RF output port.

The HMC-C078 has integrated voltage regulators on both the positive and negative supply.

### Electrical Specifications, $T_A = +25$ °C +Vdc = +12V, -Vdc = -7V

Parameter	Conditions	Min	Typ.	Max	Units
Input Frequency Range			2 - 20		GHz
Frequency Flatness	Pin= -25 dBm		$\pm 1$		dB
Log Linearity	Pin= -40 dBm to +0 dBm		$\pm 1$		dBm
Log Linearity over Temperature	-55 to +85 °C, Pin= -25 dBm		$\pm 1$		dB
Minimum Logging Range	to $\pm 3$ dB error		-45		dBm
Maximum Logging Range	to $\pm 3$ dB error		5		dBm
Input Return Loss			8		dB
Output Return Loss			15		dB
Small Signal Gain		40	44		dB
Saturated Output Power (10 GHz)		5	7	10	dBm
Log Video Minimum Output Voltage		0.1	0.25	0.5	V
Log Video Maximum Output Voltage		2.3	2.5	2.7	V

For price, delivery, and to place orders, please contact Hittite Microwave Corporation:  
20 Alpha Road Chelmsford, MA 01824 Phone: 978-250-3343 Fax: 978-250-3373  
Order Online at [www.hittite.com](http://www.hittite.com)



**SUCCESSIVE DETECTION LOG VIDEO AMPLIFIER (SDLVA)  
MODULE w/ LIMITED RF OUTPUT, 2 - 20 GHz**

**Electrical Specifications, (continued)**

Parameter	Conditions	Min	Typ.	Max	Units
Tangential Signal Sensitivity (TSS)	2 - 20 GHz, 20 MHz VBW		-54		dBm
Log Video Output Rise Time	Pin = -20 dBm, 10% to 90%		5		ns
Log Video Output Fall Time	Pin = -20 dBm, 90% to 10%		8		ns
Log Video Recovery Time	-40 dBm to 0 dBm		25		ns
Log Video Output Slope	Pin = 35 dBm	37	42	47	mV/dB
Log Video Output Slope Variation over Temperature	@ 10 GHz		10		$\mu\text{V}/\text{dB}^\circ\text{C}$
Log Video Propagation Delay			20		ns
+Vdc Voltage Range		9	12	15	V
-Vdc Voltage Range		-6	-7	-15	V
Supply Current (+Idc)			370	400	mA
Supply Current (-Idc)			20		mA

**Error Flatness vs. Input Power Over Frequency**

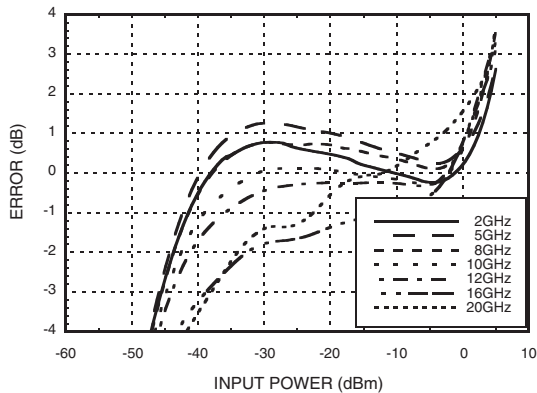

**X-Band Error Flatness vs. Input Power Over Frequency**

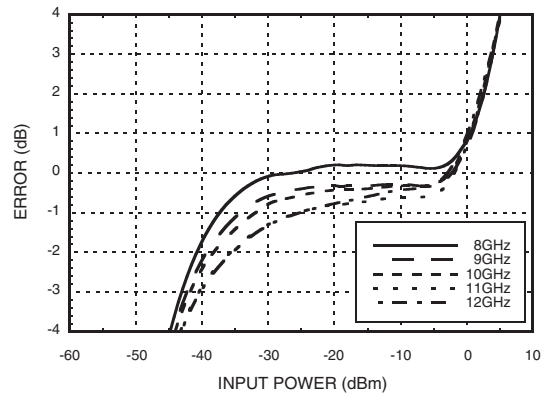

**VIDEO OUT & Error vs. Input Power, Fin = 2 GHz**

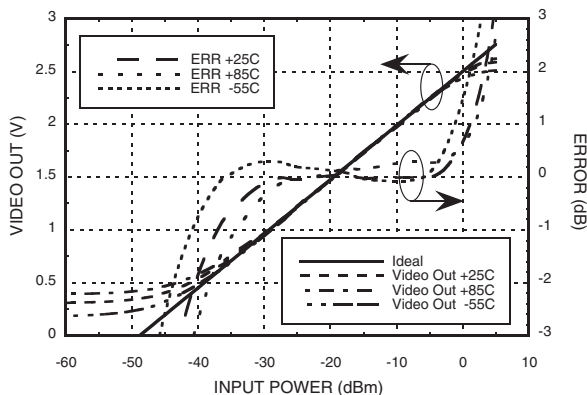

**VIDEO OUT & Error vs. Input Power, Fin = 5 GHz**

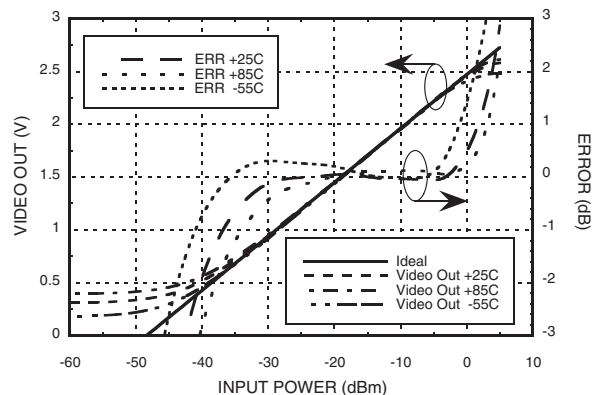



**SUCCESSIVE DETECTION LOG VIDEO AMPLIFIER (SDLVA)  
MODULE w/ LIMITED RF OUTPUT, 2 - 20 GHz**

**VIDEO OUT & Error  
vs. Input Power,  $F_{in} = 8$  GHz**

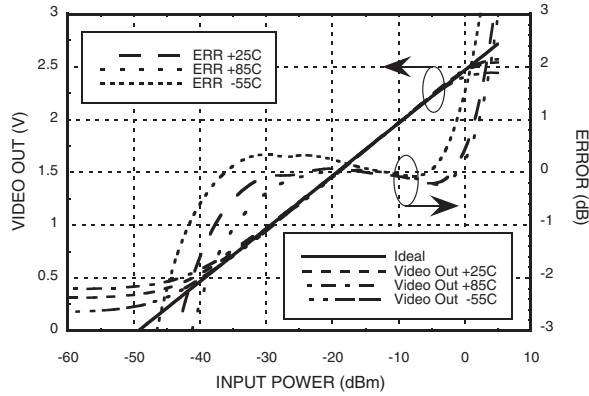

**VIDEO OUT & Error  
vs. Input Power,  $F_{in} = 10$  GHz**

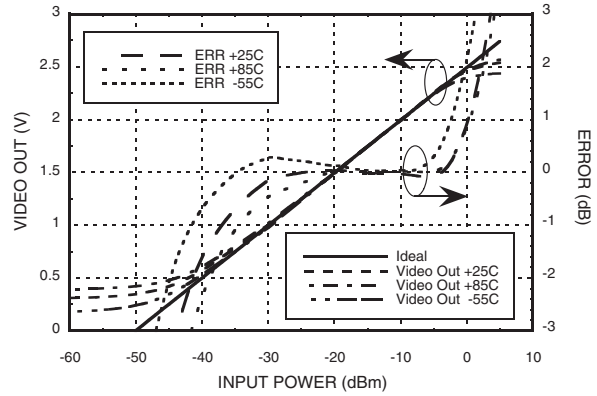

**VIDEO OUT vs. Error  
vs. Input Power,  $F_{in} = 12$  GHz**

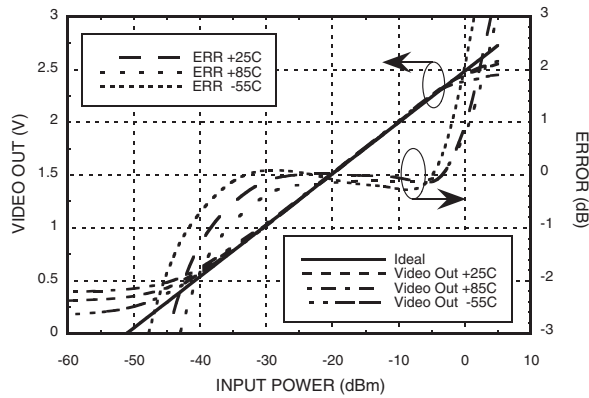

**VIDEO OUT & Error  
vs. Input Power,  $F_{in} = 16$  GHz**

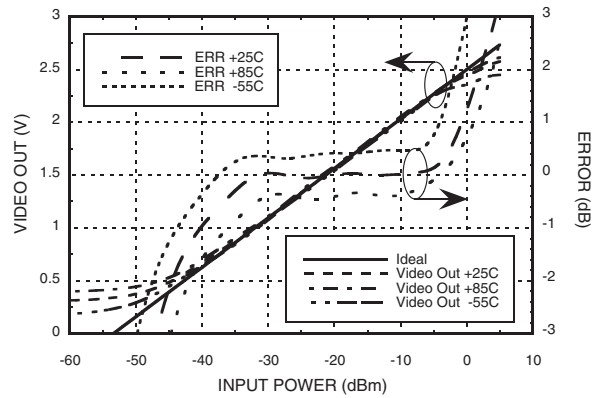

**VIDEO OUT & Error  
vs. Input Power,  $F_{in} = 20$  GHz**

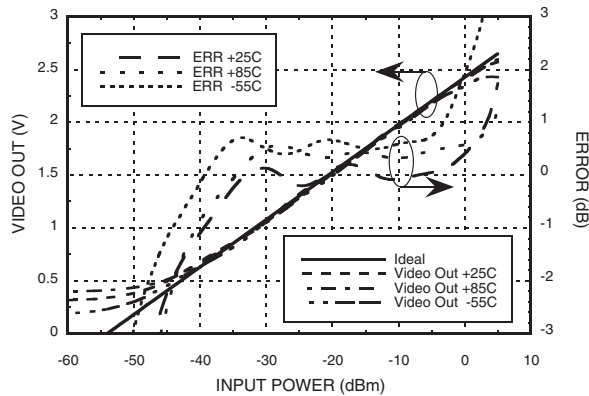

**VIDEO OUT vs. Frequency  
Over Input Power & Temperature**

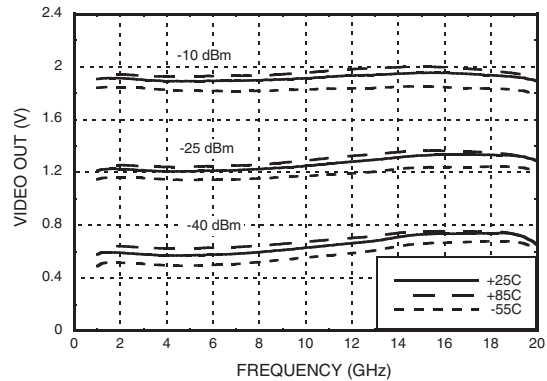



**SUCCESSIVE DETECTION LOG VIDEO AMPLIFIER (SDLVA)  
MODULE w/ LIMITED RF OUTPUT, 2 - 20 GHz**

**Output Power vs. Frequency  
Over Input Power & Temperature**

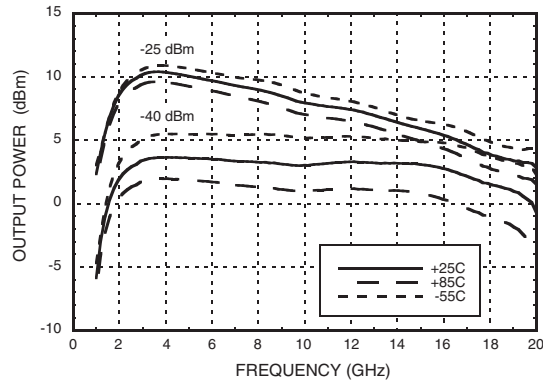

**Output Power vs. Input Power**

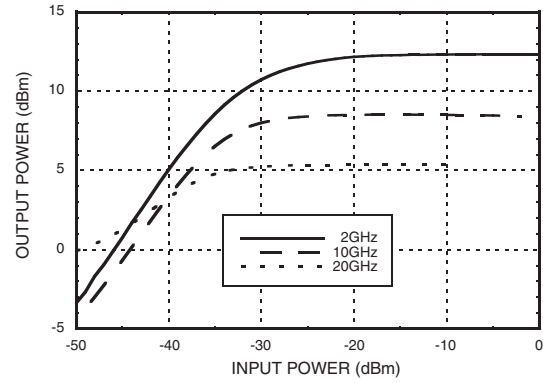

**Return Loss vs. Frequency**

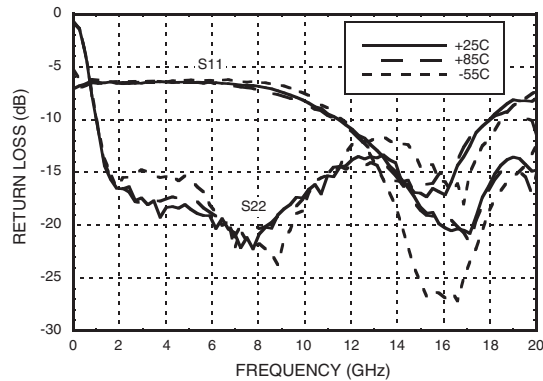

**Rise Time @ 10 GHz @ -20 dBm**

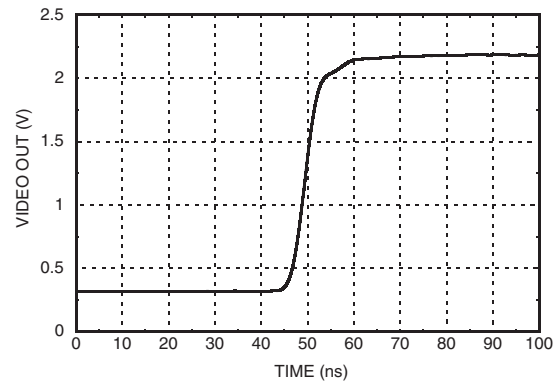

**Fall Time @ 10 GHz @ -20 dBm**

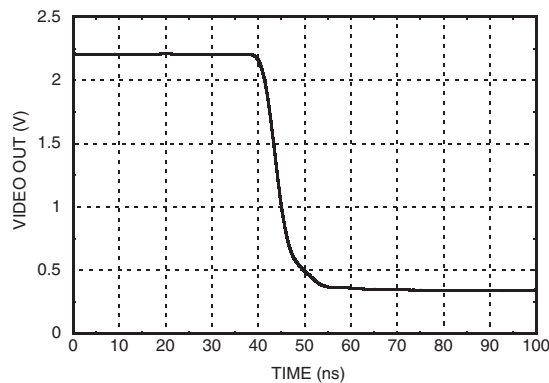

**Absolute Maximum Ratings**

RF Input Power	+10 dBm
Junction Temperature	125 °C
Continuous P <sub>diss</sub> (T=85°C)	6.3 W
+V <sub>dcc</sub>	+15V
-V <sub>dcc</sub>	-15V
Storage Temperature	-65 to +150 °C
Operating Temperature	-55 to +85 °C
ESD Sensitivity (HBM)	Class 0
HMC-C078 is a Class 0 ESD sensitive part. RF input and RF output pass 50V ESD HBM exposure.	



**ELECTROSTATIC SENSITIVE DEVICE  
OBSERVE HANDLING PRECAUTIONS**



**SUCCESSIVE DETECTION LOG VIDEO AMPLIFIER (SDLVA)  
MODULE w/ LIMITED RF OUTPUT, 2 - 20 GHz**

**Outline Drawing**

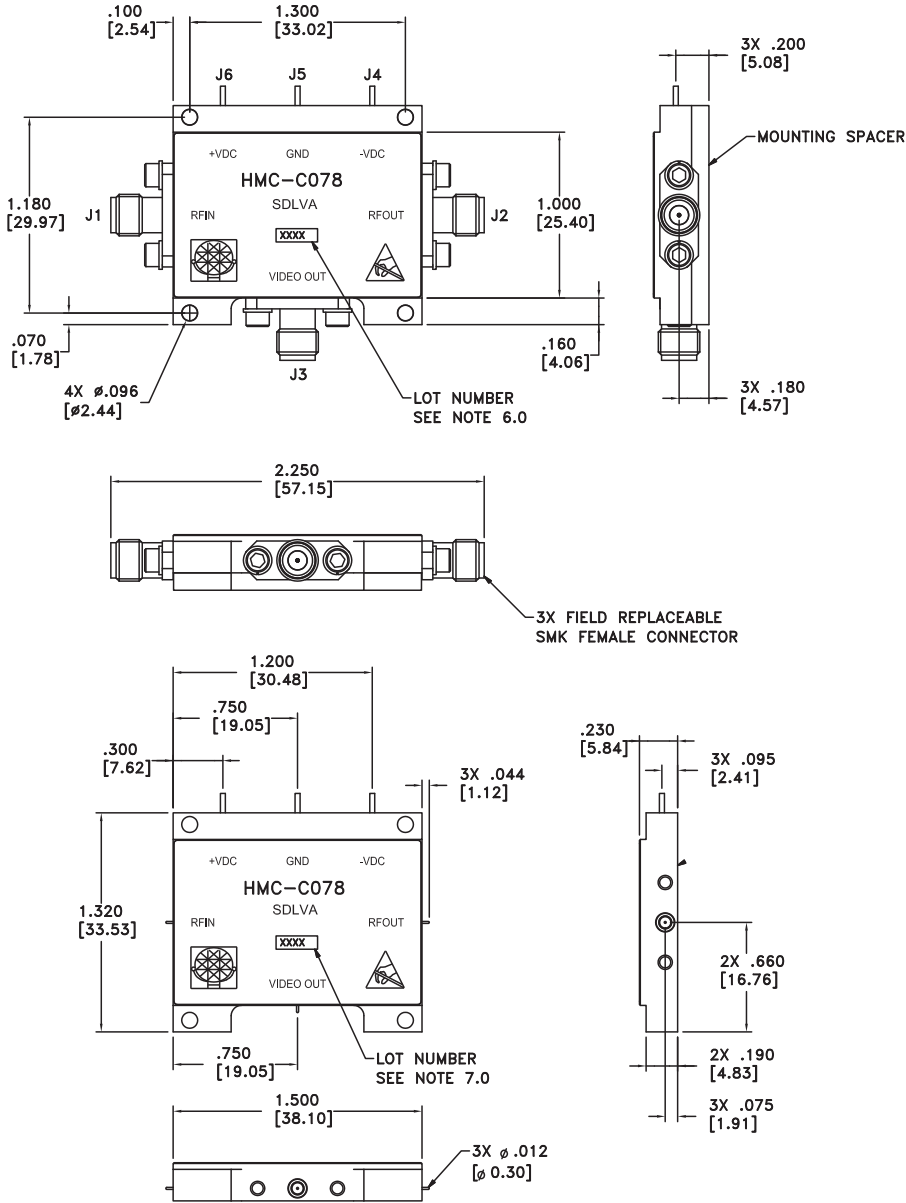

VIEW SHOWN WITH CONNECTORS REMOVED

**Package Information**

Package Type	C-21
Package Weight [1]	39.5 gms
Spacer Weight	8.5 gms

[1] Includes the connectors

[2]  $\pm$ 1 gms Tolerance



**NOTES:**

- 1.0 PACKAGE, LEADS COVER MATERIAL: KOVAR
- 2.0 FINISH: GOLD PLATE OVER NICKEL PLATE.
- 3.0 MOUNTING SPACER: NICKEL PLATED ALUMINUM.
- 4.0 ALL DIMENSIONS ARE IN INCHES [MILLIMETERS].
- 5.0 TOLERANCES:  
5.1 .XX =  $\pm$ .02 [0.5 mm]  
5.1 .XXX =  $\pm$ .010 [0.25 mm]
- 6.0 MARK LOT NUMBER ON .080 X .250 LABEL APPROXIMATELY WHERE SHOWN, WITH .030 MINIMUM TEXT HEIGHT.
- 7.0 USE MOUNTING SPACER PART NUMBER 125177.

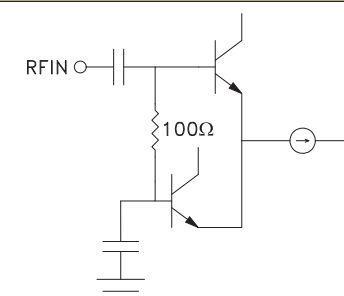
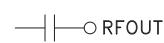

**SUCCESSIVE DETECTION LOG VIDEO AMPLIFIER (SDLVA)  
MODULE w/ LIMITED RF OUTPUT, 2 - 20 GHz**

**Pin Descriptions**

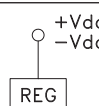
Pin Number	Function	Description	Interface Schematic
1	RFIN	RF Input pin.	
2	RFOUT	This pin is AC coupled and matched to 50 Ohms	
3	VIDEO OUT	Video Out is a voltage that is proportional to the log of the Input Power. (50 Ohm optimal load)	
4, 6	-Vdc, +Vdc	Bias Supply.	
5	GND	This pin must be connected to a high quality RF/DC ground.	