

PURE SPECTRUM TCXO - VCTCXO Specification: TX14- Sinewave Series



2111 Comprehensive Drive
Aurora, Illinois 60505
Phone: 630-851-4722
Fax: 630-851-5040
www.conwin.com

Description:

The Connor-Winfield's TX14 Sinewave Series of Temperature Compensated Crystal Oscillators and Voltage Controlled Temperature Compensated Crystal Oscillators are designed for use in S3 Telecom Applications. Through the use of Analog Temperature Compensation, this device is capable of holding sub 1-ppm stabilities over the commercial or the industrial temperature ranges. All models will meet ± 4.6 ppm accuracies for twenty years. STRATUM 3 compliant models are available.

The TX14 series provides temperature stabilities in the range of ± 0.28 ppm to ± 2.50 ppm, over the commercial, extended commercial or the industrial temperature range.

The TX14 series is available with Sinewave output along optional Electronic Frequency Tuning (VCTCXO). These oscillators provide outstanding phase noise characteristics that will meet the most stringent requirements.



Features:

- TCXO / VCTCXO
- Frequency Range: 6.4 to 100 MHz
- 3.3 Vdc or 5.0 Vdc Operation
- Sinewave Output
- Frequency Stabilities Available: ± 0.28 ppm, **STRATUM 3** ± 0.5 ppm, ± 1.0 ppm or ± 2.5 ppm
- Temperature Ranges Available: 0 to 70°C, -20 to 70°C or -40 to 85°C
- Frequency Tolerance: ± 4.60 ppm for 20 years.
- Low Jitter <1ps RMS
- Voltage Control on Pin 1
- Hermetically Sealed 14 Pin DIP Package
- Through-hole or gull wing SMT
- RoHS Compliant / Lead Free **RoHS**
- Recommended for New Designs

TX14 Package Outline

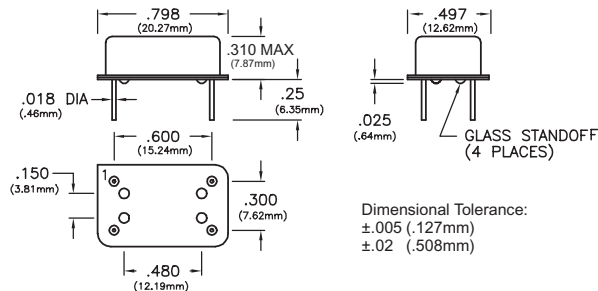

Marking Diagram

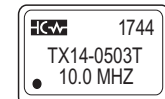

Pin Connections

- 1: NC or Voltage Control (Vc)
- 7: Ground
- 8: Output
- 14: Supply Voltage (Vcc)

JTX14 Package Outline

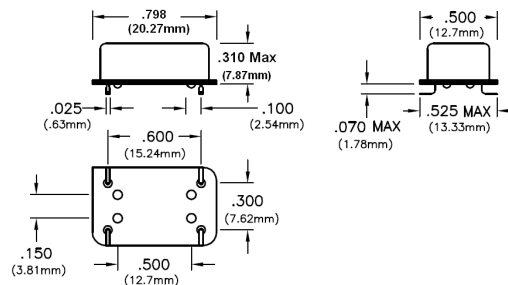

JTX14 Suggested Pad Layout

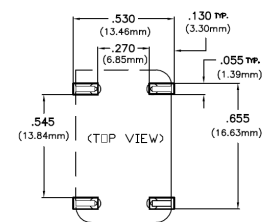

Ordering Information

TX14-	28	0	7	T	-020.0M
Oscillator Type	Frequency Stability	Temperature Range	Supply Voltage Output Type	TCXO Type	Output Frequency
TX14 = 14-Pin DIP Through-hole JTX14 = 14-Pin DIP Gull-wing SMT	28 = ± 0.28 ppm 05 = ± 0.50 ppm 10 = ± 1.00 ppm 25 = ± 2.50 ppm	0 = 0 to 70°C 1 = -20 to 70°C 2 = -40 to 85°C	7 = 3.3 Vdc, Sinewave 8 = 5.0 Vdc, Sinewave	T = TCXO (Fixed Freq.) V = VCTCXO (Voltage Controlled)	Frequency Format -xxx.xM Min.* -xxx.xxxxxxM Max.*

Example Part Numbers:

TX14-2807T-020.0M = 14 Pin DIP package, ± 0.28 ppm, 0 to 70°C, 3.3 Vdc, Sinewave Output, TCXO, Output Frequency 20.0 MHz
TX14-0528V-38.88M = 14 Pin DIP package, ± 0.50 ppm, -40 to 85°C, 5.0 Vdc, Sinewave Output, VCTCXO, 38.88 MHz

*Min 1, Max 6 digits after the decimal point.
M = MHz



Bulletin **Tx396**
Page **1 of 4**
Revision **03**
Date **13 Dec 2017**



Absolute Maximum Ratings

Parameter	Minimum	Nominal	Maximum	Units	Notes
Storage Temperature	-55	-	125	°C	
Supply Voltage 3.3 Vdc (Vcc)	-0.5	-	4.5	Vdc	
5.0 Vdc (Vcc)	-0.5	-	7.0	Vdc	
Control Voltage (Vc)	-0.5	-	Vcc+0.5	Vdc	

Absolute Ratings: Stresses beyond those listed under "absolute maximum ratings" may cause permanent damage to the device. These are stress ratings only. The functional operation of the device at those or any other conditions beyond those indicated under "recommended operating conditions" is not implied. Exposure to conditions outside the "recommended operating conditions" for any extended period of time may adversely impact device reliability and result in failures not covered by warranty.

Operating Specifications for (J)TX14-28xxx Series

Parameter	Minimum	Nominal	Maximum	Units	Notes
Frequency Range (Fo)	6.4	-	40	MHz	
Frequency Calibration	-1.0	-	1.0	ppm	1
Frequency Stability vs. Change in Temperature: (See Ordering Information)					✓STRATUM 3
Stability Code 28	-0.28	-	0.28	ppm	2
Holdover Stability	-0.32	-	0.32	ppm	3
Frequency Stability vs. Load	-50	-	50	ppb	±5%
Frequency Stability vs. Voltage	-50	-	50	ppb	±5%
Aging / Life (20 Years)	-3.0	-	3.0	ppm	
Aging / Day (@25 °C)	-40	-	40	ppb/day	
Aging / Second	-4.63E-13	-	4.63E-13		
Total Frequency Tolerance (20 Years)	-4.60	-	4.60	ppm	4

Operating Specifications for (J)TX14-05xxx Series

Parameter	Minimum	Nominal	Maximum	Units	Notes
Frequency Range (Fo)	6.4	-	60	MHz	
Frequency Calibration	-1.0	-	1.0	ppm	1
Frequency Stability vs. Change in Temperature: (See Ordering Information)					
Stability Code 05	-0.50	-	0.50	ppm	2
Frequency Stability vs. Load	-50	-	50	ppb	±5%
Frequency Stability vs. Voltage	-50	-	50	ppb	±5%
Aging / Life (20 Years)	-3.0	-	3.0	ppm	
Total Frequency Tolerance (20 Years)	-4.60	-	4.60	ppm	4

Operating Specifications for (J)TX14-10xxx Series

Parameter	Minimum	Nominal	Maximum	Units	Notes
Frequency Range (Fo)	6.4	-	100	MHz	
Frequency Calibration	-1.0	-	1.0	ppm	1
Frequency Stability vs. Change in Temperature: (See Ordering Information)					
Stability Code 10	-1.00	-	1.00	ppm	2
Frequency Stability vs. Load	-50	-	50	ppb	±5%
Frequency Stability vs. Voltage	-50	-	50	ppb	±5%
Aging / Life (20 Years)	-3.0	-	3.0	ppm	
Total Frequency Tolerance (20 Years)	-4.60	-	4.60	ppm	4

Operating Specifications for (J)TX14-25xxx Series

Parameter	Minimum	Nominal	Maximum	Units	Notes
Frequency Range (Fo)	6.4	-	100	MHz	
Frequency Calibration	-1.0	-	1.0	ppm	1
Frequency Stability vs. Change in Temperature: (See Ordering Information)					
Stability Code 25	-2.50	-	2.50	ppm	2
Frequency Stability vs. Load	-50	-	50	ppb	±5%
Frequency Stability vs. Voltage	-50	-	50	ppb	±5%
Aging / Life (20 Years)	-3.0	-	3.0	ppm	
Total Frequency Tolerance (20 Years)	-4.60	-	4.60	ppm	4

Notes:

1. Initial calibration @ 25°C. Specifications at time of shipment after 48 hours of operation. For VCTCXO control voltage must be fixed.
2. Frequency stability vs. change in temperature. $[\pm(F_{max} - F_{min})/(2 \cdot F_0)]$.
3. Inclusive of frequency stability, supply voltage change (±1%), aging, for 24 hours.
4. Inclusive of calibration @ 25°C, frequency vs. change in temperature, change in supply voltage (±5%), load change (±5%), shock and vibration and 20 years aging.

Bulletin	Tx396
Page	2 of 4
Revision	03
Date	13 Dec 2017



Operating Temperature Ranges

Parameter	Minimum	Nominal	Maximum	Units	Notes
Operating Temperature Range: (See Ordering Information)					
Temperature Code 0	0	-	70	°C	
Temperature Code 1	-20	-	70	°C	
Temperature Code 2	-40	-	85	°C	

Operating Specifications

Parameter	Minimum	Nominal	Maximum	Units	Notes
Supply Voltage: (Vcc) (See Ordering Information)					
Supply Voltage Code 7	3.13	3.30	3.47	Vdc	±5%
Supply Voltage Code 8	4.75	5.00	5.25	Vdc	±5%
Supply Current Vcc = Nominal Voltage	-	6	10	mA	
Static Temperature Hysteresis	-0.4	-	0.4	ppm	5
Jitter:					
Period Jitter	-	3	5	ps RMS	
Phase Jitter (BW: 12 KHz to Fo/2)	-	0.5	1.0	ps RMS	
Typical SSB Phase Noise: (Fo = 20 MHz)					
@ 10 Hz offset	-	-90	-85	dBC/Hz	
@ 100 Hz offset	-	-120	-115	dBC/Hz	
@ 1 KHz offset	-	-140	-135	dBC/Hz	
@ 10 KHz offset	-	-150	-145	dBC/Hz	
@ >100 KHz offset	-	-152	-150	dBC/Hz	
Start-Up Time	-	-	1	ms	

Sinewave Output Characteristics

Parameter	Minimum	Nominal	Maximum	Units	Notes
Load	-	50	-	Ohm	AC Coupled
Output Voltage	3.0	6.0	-	dBm	
Harmonics	-	-	-30	dBc	
Spuious	-	-	-80	dBc	

Voltage Control Input Characteristics (Pin 1) Optional

Parameter	Minimum	Nominal	Maximum	Units	Notes
Control Voltage Range: (Vc) Voltage Control Code V (See Ordering Information)					
Vcc = 3.3 Vdc	0.30	1.65	3.00	V	
Vcc = 5.0 Vdc	0.5	2.5	4.5	V	
Frequency Pullability	±10.0	-	-	ppm	6
Input Impedance	100K	-	-	Ohms	
Linearity	±5	-	-	%	
Slope	Positive Transfer Function				

Package Characteristics

Package	14 Pin DIP Hermetically Sealed Metal Package
---------	--

Environmental Characteristics

Shock	500 G's 1ms, Halfsine, 3 shocks per direction, per MIL-STD 202G, Method 213B Test Condition D.
Sinusoidal Vibration	0.06" D.A. or 10G's Peak, 10 to 500 Hz, per MIL-STD-202G, Method 204D, Test Condition A.
Random Vibration	5.35 G's rms. 20 to 2000 Hz per MIL-STD-202G, Method 214, Test Condition 1A, 15 minutes each axis.
Moisture	10 cycles, 95% RH, Per MIL-STD-202G, Method 112.
Marking Permanency	Per MIL-STD-202G, Method 215J.
Solder Process	RoHS compliant, lead free. See solder profile on page 4.

Notes:

5. Frequency change after reciprocal temperature ramped over the operating range. Frequency measured before and after at 25°C.
6. Referenced to Fo.

Bulletin	Tx396
Page	3 of 4
Revision	03
Date	13 Dec 2017

Sinewave Test Circuit

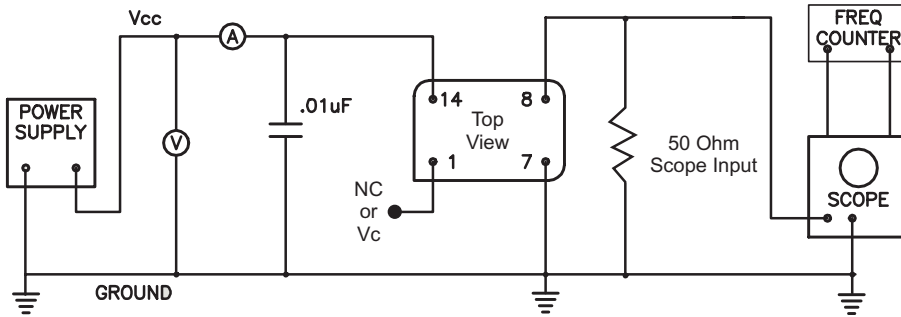

Sinewave Output Waveform

Sinewave Output, 3 dBm minimum into 50 Ohms

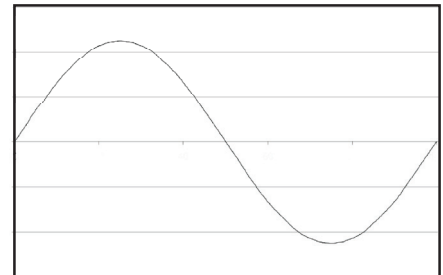

Phase Noise Plot

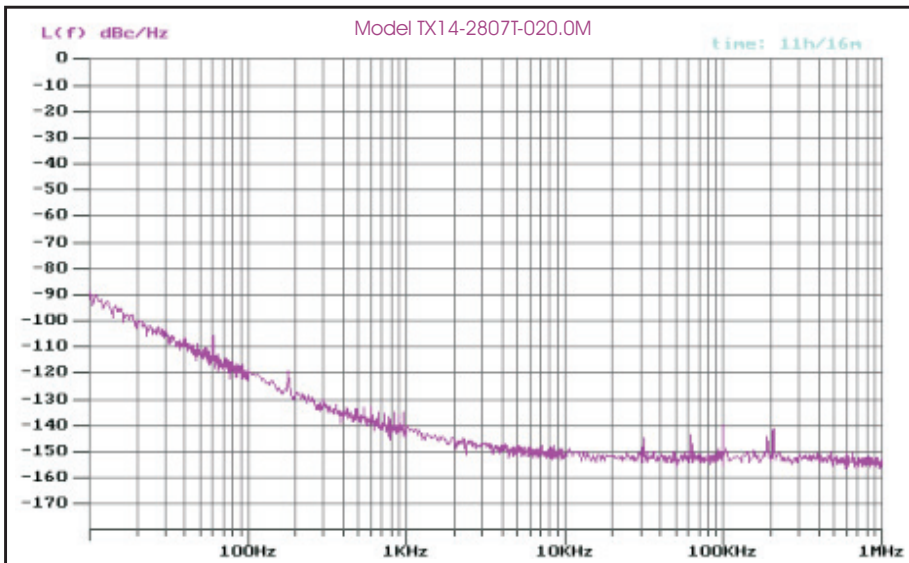

RoHS Solder Profile

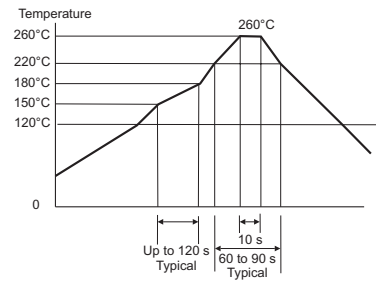

Meets IPC/JEDEC J-STD-020C