

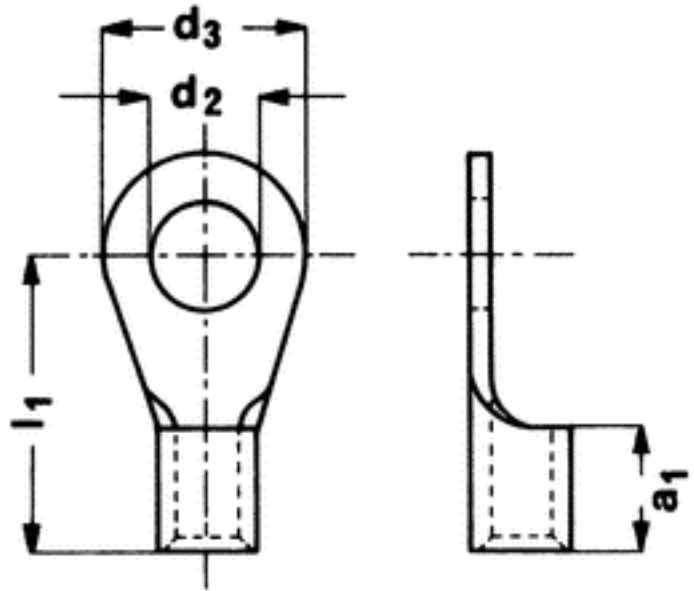

## Characteristics and dimensions of terminals

Part number	03423.311.011
Specification	Cable lug ring type
Material	SE-Cu
Surface / Colour	Sn 3
Form	Single form
Single part	X
Packing unit / piece	400
Section area (mm <sup>2</sup> )	10.00-16.00
DIN	46234
Nominal size	10-16
Material thickness (mm)	1.20
Footnote	Type test according to VG 96933-13
a <sub>1</sub>	10.00
d <sub>2</sub>	10.50
d <sub>3</sub>	18.00
l <sub>1</sub>	24.00



Note: The drawing only gives an overview of the geometry of the part. The crimp area is shown as supplied in strip form. A technical drawing is available on request.

[Contents of your inquiry](#)

Packing Units (per 400 pieces)

CW