



SANYO Semiconductors

DATA SHEET

LA76835NM — Monolithic Linear IC For PAL/NTSC Color Television Sets VIF/SIF/Y/C/Deflection Implemented in a Single Chip

Overview

The LA76835NM is VIF/SIF/Y/C/Deflection implemented in a single chip for PAL/NTSC color television sets

Functions

- VIF/SIF/Y/C/Deflection implemented in a single chip.
- I²C bus control.

Specifications

Maximum Ratings at Ta = 25°C

Parameter	Symbol	Conditions	Ratings	Unit
Maximum supply voltage	V ₅ max		7.0	V
	V ₃₂ max		7.0	V
	V ₅₃ max		7.0	V
	V ₇₄ max		9.3	V
Maximum supply current	I ₁₇ max		25	mA
	I ₂₉ max		35	mA
Allowable power dissipation	Pd max	Ta ≤ 65°C *	1.5	W
Operating temperature	Topr		-10 to +65	°C
Storage temperature	Tstg		-55 to +150	°C

* Mounted on a board: 114.3×76.1×1.6mm³ glass epoxy board

- Any and all SANYO Semiconductor products described or contained herein do not have specifications that can handle applications that require extremely high levels of reliability, such as life-support systems, aircraft's control systems, or other applications whose failure can be reasonably expected to result in serious physical and/or material damage. Consult with your SANYO Semiconductor representative nearest you before using any SANYO Semiconductor products described or contained herein in such applications.
- SANYO Semiconductor assumes no responsibility for equipment failures that result from using products at values that exceed, even momentarily, rated values (such as maximum ratings, operating condition ranges, or other parameters) listed in products specifications of any and all SANYO Semiconductor products described or contained herein.

SANYO Semiconductor Co., Ltd.

TOKYO OFFICE Tokyo Bldg., 1-10, 1 Chome, Ueno, Taito-ku, TOKYO, 110-8534 JAPAN

LA76835NM

Operating Conditions at $T_a = 25^\circ\text{C}$

Parameter	Symbol	Conditions	Ratings	Unit
Recommended supply voltage	V_5		5.0	V
	V_{32}		5.0	V
	V_{53}		5.0	V
	V_{74}		9.0	V
Recommended supply current	I_{17}		19	mA
	I_{29}		29	mA
Operating supply voltage range	V_5 op		4.7 to 5.3	V
	V_{32} op		4.7 to 5.3	V
	V_{53} op		4.7 to 5.3	V
	V_{74} op		8.7 to 9.3	V
Operating supply current range	I_{19} op		26 to 32	mA
	I_{26} op		24 to 33	mA

Electrical Characteristics $T_a = 25^\circ\text{C}$, $V_{CC1} = V_5 = V_{53} = 5.0\text{V}$, $V_{CC2} = V_{74} = 9.0\text{V}$, $I_{CC1} = I_{17} = 19\text{mA}$,
 $I_{CC2} = I_{29} = 29\text{mA}$

Parameter	Symbol	Conditions	Ratings			Unit
			min	typ	max	
Circuit voltage, current						
IF supply current	I_5	$V_5 = 5\text{V}$, $V_{76} = 2.5\text{V}$	42.0	50.0	58.0	mA
RGB supply voltage	V_{17}	$I_{17} = 19\text{mA}$		8.0		V
Horizontal supply voltage	V_{29}	$I_{29} = 29\text{mA}$		5.0		V
Video/Vertical supply current	I_{53}	$I_{53} = 5\text{V}$		94.0		mA
CPU Reset operating voltage	V_{Reset}		3.2	3.6	4.0	V
FM supply current	I_{74}	$V_{74} = 9\text{V}$	7.0	8.0	9.0	mA
VIF block						
Maximum RFAGC voltage	V_{RFH}	$CW = 80\text{dB}\mu$, $DAC = 0$	8.5	9.0		Vdc
Minimum RFAGC voltage	V_{RFL}	$CW = 80\text{dB}\mu$, $DAC = 63$	0.0	0.2	0.7	Vdc
RF AGC Delay Pt (@DAC = 0)	RF_{AGC0}	$DAC = 0$	95			dB μ
RF AGC Delay Pt (@DAC = 63)	RF_{AGC63}	$DAC = 63$			85	dB μ
Input sensitivity	V_i	Output-3db		45	50	dB μ
No-signal video output voltage	V_{On}	No signal IFAGC = "1"	2.9	3.3	3.7	Vdc
Sync signal tip level	V_{Otip}	$CW = 80\text{dB}\mu$	1.4	1.7	2.0	Vdc
Video output amplitude	V_O	$80\text{dB}\mu$, $AM = 78\%$, $f_m = 15\text{kHz}$	1.3	1.4	1.5	Vp-p
Video S/N	S/N	$CW = 80\text{dB}\mu$	43	47		dB
C-S beat level	IC-S	$V_{3.58\text{MHz}/V_{920\text{kHz}}}$	54	60		dB
Differential gain	DG	$80\text{dB}\mu$, 87.5% Video MOD		3.0	8.0	%
Differential phase	DP	$80\text{dB}\mu$, 87.5% Video MOD		1.0	8.0	deg
Maximum AFT output voltage	V_{AFTH}	$CW = 80\text{dB}\mu$, frequency variations	4.3	4.8	5.0	Vdc
Minimum AFT output voltage	V_{AFTL}	$CW = 80\text{dB}\mu$, frequency variations	0.0	0.2	0.7	Vdc
AFT detection sensitivity	V_{AFTS}	$CW = 80\text{dB}\mu$, frequency variations	15.0	25.0	35.0	mV/kHz
APC pull-in range (U)	fPU	$CW = 80\text{dB}\mu$, frequency variations	1.0			MHz
APC pull-in range (L)	fPL	$CW = 80\text{dB}\mu$, frequency variations	1.0			MHz
SIF block						
FM detection output voltage	SOADJ		205	260	330	mVrms
FM limiting sensitivity	SLS	Output -3dB		48	54	dB μ
FM detection output f characteristics	SF	$f_m = 100\text{kHz}$	-0.5	3.0	6.0	dB
FM detection output distortion	STHD	$FM = \pm 25\text{kHz}$			1.0	%
AM rejection ratio	SAMR	$AM = 30\%$	48	57		dB
SIF S/N	SSN	DIN.Andio	57	62		dB
De-emph time constant	SNTC	$f_m = 2.12\text{kHz}$	1.5	2.5	3.5	dB

Continued on next page.

LA76835NM

Continued from preceding page.

Parameter	Symbol	Conditions	Ratings			Unit	
			min	typ	max		
AUDIO block							
Maximum gain	AGMAX	1kHz, Volume = "127"	-3.0	0.0	3.0	dB	
Variable range	ARANGE	1kHz, Volume = "0"	60	70		dB	
Frequency characteristics	AF	20kHz, Volume = "127"	-3.0	0.0	3.0	dB	
Mute	AMUTE	1kHz, AUDIO MUTE = "1"	70	75		dB	
Distortion	ATHD	1kHz, Volume = "127"			0.5	%	
S/N	ASN	DIN.Audio	60	65		dB	
Crosstalk	ACT	1kHz, AUDIO SW = "0"	70	75		dB	
Chroma block							
ACC amplitude characteristics 1	ACCM1_N	Input: +6dB/0dB 0dB = 40IRE	0.8	1.0	1.2	Ratio	
ACC amplitude characteristics 2	ACCM2_N	Input: -14dB/0dB	0.7	1.0	1.1	Ratio	
B-Y/Y amplitude ratio	CLRBY		100	130	170	%	
Color control characteristics	1	CLRMN	Color MAX/CEN	1.6	1.8	2.2	Ratio
	2	CLRMM	Color MAX/MIN	30	45	70	dB
Color control sensitivity	CLRSE		1	1.4	4	%/bit	
Tint center	TINCEN		-10	0	10	deg	
Tint control	MAX	TINMAX	40	50		deg	
	MIN	TINMIN		-50	-40	deg	
Tint control sensitivity	TINSE		1.4	1.55	1.7	deg	
Tint dependence on color L	CLRPL		-3.0	0	3	deg	
Tint dependence on color H	CLRPH		-3.0	0	3	deg	
Demodulation output ratio R-Y/B-Y	RB	R-Y/B-Y_GainBalance_DAC, R-Y/B-Y_Angle_DAC = Center	0.75	0.85	0.95	Ratio	
Demodulation output ratio G-Y/B-Y	GB	R-Y/B-Y_GainBalance_DAC, R-Y/B-Y_Angle_DAC = Center	0.20	0.30	0.40	Ratio	
Demodulation angle R-Y/B-Y	ANGRB1	R-Y/B-Y_Angle_DAC = Center	95	105	115	deg	
Demodulation angle R-Y/B-Y control 1	ANGRB2	R-Y/B-Y_Angle_DAC = Maximum	105	115		deg	
Demodulation angle R-Y/B-Y control 2	ANGRB3	R-Y/B-Y_Angle_DAC = Minimum		95	105	deg	
Demodulation angle G-Y/B-Y	ANGGB1	R-Y/B-Y_Angle_DAC = Center	-128	-118	-108	deg	
Demodulation angle G-Y/B-Y control	ANGGB2	G-Y_Angle_DAC = 1	-117	-107	-97	deg	
Killer operating point 2	KILL	0dB = 40IRE, ColorKiller ope. = 2	-31	-25	-21	dB	
Killer operating point 4	KILL4	0dB = 40IRE, ColorKiller ope. = 4	-33	-27	-22	dB	
Killer operating point difference	D_KILL	KILL-KILL4	0.5	2	5	dB	
Chroma VCO free-running frequency	CVCOF		-320	0	320	Hz	
APC pull-in range (+)	PLINPO		350			Hz	
APC pull-in range (-)	PLINNO				-350	Hz	
Static phase error +	SPER_P	Fsc: +200Hz	-15	-5	0	deg	
Static phase error -	SPER_N	Fsc: -200Hz	0	5	15	deg	
fsc output amplitude	C_FSC	reference data		300		mVp-p	
Residual higher harmonic level B	E_CAR_B				300	mVp-p	
Residual higher harmonic level R	E_CAR_R				300	mVp-p	
Residual higher harmonic level G	E_CAR_G				300	mVp-p	
C-BPF1A (3.08MHz)	CBP308	Reference: 3.48MHz	-5.0	-1.5	0.0	dB	
C-BPF1B (3.88/3.28MHz)	CBP03	Reference: 3.28MHz	-2.0	0.0	2.0	dB	
C-BPF1C (4.08/3.08MHz)	CBP05	Reference: 3.08MHz	-3	0	3	dB	

Continued on next page.

LA76835NM

Continued from preceding page.

Parameter	Symbol	Conditions	Ratings			Unit	
			min	typ	max		
OSD block							
OSD Fast SW threshold	FSTH		0.5	0.8	1.1	V	
Digital OSD Red output amplitude @OSD Cnt: 0	ROSDDIG0			60		IRE	
Digital OSD Red output amplitude @OSD Cnt: 3	ROSDDIG3			150		IRE	
Digital OSD Green output amplitude @OSD Cnt: 0	GOSDDIG0			66		IRE	
Digital OSD Green output amplitude @OSD Cnt: 3	GOSDDIG3			150		IRE	
Digital OSD Blue output amplitude @OSD Cnt: 0	BOSDDIG0			60		IRE	
Digital OSD Blue output amplitude @OSD Cnt: 3	BOSDDIG3			150		IRE	
Analog OSD R output amplitude gain match	RRGB		1.0	1.2	1.4	Ratio	
Analog OSD G output amplitude gain match	GRGB		1.0	1.2	1.4	Ratio	
Analog OSD B output amplitude gain match	BRGB		1.0	1.2	1.4	Ratio	
RGB output (cutoff drive) block							
Brightness control	Normal	BRT64		1.9	2.2	2.5	V
	Hi brightness Max	BRT127		35	40	45	IRE
	Low brightness Min	BRT0		-45	-40	-35	IRE
Cutoff control (min)	Vbias0		1.9	2.2	2.5	V	
Bias control (max)	Vbias255		2.9	3.2	3.5	V	
Resolution	Vbiassns			4		mV/Bit	
Sub-bias control resolution	Vsbiassns			8		mV/Bit	
Drive adjustment Normal output (R, B) 50IRE	Rbout64		0.60	0.90	1.20	Vp-p	
Drive adjustment Maximum output (R, B) 50IRE	RBout127		1.05	1.35	1.65	Vp-p	
Drive adjustment Normal output (G) 50IRE	Gout10		0.60	0.90	1.20	Vp-p	
Drive adjustment Maximum output (G) 50IRE	Gout15		0.70	1.00	1.30	Vp-p	
Drive adjustment Output attenuation (R, B)	DrGainRB		8	10	12	dB	
Drive adjustment Output attenuation (G)	DrGainG		1.5	3.5	5.5	dB	
RGB output DC difference voltage	RGB_DC		0		0.2	V	
Video SW block							
Video signal input 1DC voltage	VIN1DC		2.2	2.5	2.8	V	
Video signal input 1AC voltage	VIN1AC			1		Vp-p	
Video signal input 2DC voltage	VIN2DC		2.2	2.5	2.8	V	
Video signal input 2AC voltage	VIN2AC			1		Vp-p	
SVO terminal DC voltage	SVODC		1.7	2	2.3	V	
SVO terminal AC voltage	SVOAC		1.7	2	2.3	Vp-p	

Continued on next page.

LA76835NM

Continued from preceding page.

Parameter	Symbol	Conditions	Ratings			Unit	
			min	typ	max		
Video block							
Video overall gain (Contrast max)	CONT127		8.0	10.0	12.0	dB	
Contrast adjustment Characteristics	Normal/max	CONT90	-4.5	-3.0	-1.5	dB	
	Min/max	CONT0	-18.0	-15.0	-12.0	dB	
Video frequency characteristics	FILTER SYS = 0	BW1	1.4MHz/100kHz	-6.0	-3.0	-1.0	dB
	FILTER SYS = 2	BW2	1.8MHz/100kHz	-6.0	-3.0	-1.0	dB
	FILTER SYS = 4	BW3	3.4MHz/100kHz	-6.0	-3.0	-1.0	dB
Chroma trap amount	Ctrap	SHARPNESS = 0	-38.0	-28.0	-24.0	dB	
DC transmission amount 1	ClampG1	DCREST = 00	95.0	100.0	105.0	%	
DC transmission amount 2	ClampG2	DCREST = 01	100.0	105.0	110.0	%	
DC transmission amount 3	ClampG3	DCREST = 10	104.0	109.0	116.0	%	
DC transmission amount 4	ClampG4	DCREST = 11	108.0	113.0	118.0	%	
Y-DL TIME	TRAP1	TdY1	FILTER SYS = 000	530.0	580.0	630.0	ns
	TRAP2	TdY2	FILTER SYS = 010	350.0	400.0	450.0	ns
	TRAP OFF	TdY3	FILTER SYS = 100	300.0	350.0	400.0	ns
Pre-Shoot adjustment 1	PreShoot1	Pre-shoot adj. = 00	0.92	0.97	1.02		
Pre-Shoot adjustment 2	PreShoot2	Pre-shoot adj. = 11	1.08	1.13	1.18		
Black stretch gain	Max	BKSTmax	Gain = 10, Start = 01	23.0	28.0	33.0	IRE
	Mid	BKSTmid	Gain = 01, Start = 01	15.0	20.0	25.0	IRE
	Min	BKSTmin	Gain = 00, Start = 01	8.0	12.0	18.0	IRE
Black stretch start	Max (60IRE ΔV)	BKSTTHmax	Bain = 01, Start = 10	-8.0	0.0	8.0	IRE
	Mid (50IRE ΔV)	BKSTTHmid	Bain = 01, Start = 01	-8.0	0.0	8.0	IRE
	Min (40IRE ΔV)	BKSTTHmin	Bain = 01, Start = 00	-8.0	0.0	8.0	IRE
Sharpness variable range 1	Trap 1 mid	Sharp32T1	F = 2.2MHz, FILTER SYS = 000	5.0	8.0	11.0	dB
	Trap 1 max	Sharp63T1	F = 2.2MHz, FILTER SYS = 000	8.5	11.5	13.5	dB
	Trap 1 min	Sharp0T1	F = 2.2MHz, FILTER SYS = 000	-6.5	-3.5	-0.5	dB
Sharpness variable range 2	Trap 2 mid	Sharp32T2	F = 3MHz, FILTER SYS = 010	5.5	8.5	11.5	dB
	Trap 2 max	Sharp63T2	F = 3MHz, FILTER SYS = 010	9.5	12.5	15.5	dB
	Trap 2 min	Sharp0T2	F = 3MHz, FILTER SYS = 010	-7.0	-4.0	-1.0	dB
Sharpness variable range 3	Trap off mid	Sharp32T3	F = 5MHz, FILTER SYS = 100	5.0	8.0	11.0	dB
	Trap off max	Sharp63T3	F = 5MHz, FILTER SYS = 100	8.5	11.5	14.5	dB
	Trap off min	Sharp0T3	F = 5MHz, FILTER SYS = 100	-5.0	-2.0	1.0	dB
White peak limiter operating point	1	WPL1	APL = 100%, WPL = 0	158.0	168.0	178.0	IRE
	2	WPL2	APL = 100%, WPL = 1	107.0	117.0	127.0	IRE
	3	WPL3	APL = 100%, WPL = 2	81.0	91.0	101.0	IRE
	4	WPL4	APL = 100%, WPL = 3	56.0	66.0	76.0	IRE

Continued on next page.

LA76835NM

Continued from preceding page.

Parameter		Symbol	Conditions	Ratings			Unit
				min	typ	max	
Y gamma effective point	1	YG1	YGAMMA = 01	89.0	93.0	97.0	%
	2	YG2	YGAMMA = 10	79.0	83.0	87.0	%
	3	YG3	YGAMMA = 11	75.0	79.0	83.0	%
GRAY MODE LEVEL		GRAY	GRAY, MODE = 1, CROSS.B/W = 2	11.5	15.0	18.0	IRE
Horizontal/vertical blanking output level		RGBBLK		0.1	0.4	0.7	V
Deflection block							
Horizontal free-running frequency		fH		15576	15734	15891	Hz
Horizontal pull-in range		fH PULL		±400			Hz
Horizontal output pulse width		Hduty		36.1	37.6	39.1	µs
Horizontal output pulse saturation voltage		V Hsat		0	0.2	0.4	V
Horizontal AFC control current M		HAFCM	AFCGAIN: 0	130	180	230	µA
Horizontal AFC control current H		HAFCH	AFCGAIN: 1	190	240	290	µA
Horizontal AFC control current L		HAFCL	AFCGAIN: 0	50	90	130	µA
Horizontal output pulse phase		HPHCEN		9.5	10.5	11.5	µs
Horizontal position adjustment range		HPHrange	5bit		±2.2		µs
Horizontal position adjustment maximum variability width		HPHstep				200.0	ns
Horizontal 2nd pull-in range (min)		HPMIN		0.5	1.0	3.0	µs
Horizontal 2nd pull-in range (max)		HPMAX		15.2	16.0	17.0	µs
Vertical free-running frequency		VFR60		59.4	60.0	60.6	Hz
Vertical pull-in range		fV PULL		54.0	60.0	69.0	Hz
Horizontal output stop voltage		Hstop		3.30	3.60	3.90	V
Horizontal blanking	left @0	BLKL0	BLKL: 0000	8200	9000	9800	ns
	left @15	BLKL15	BLKL: 1111	15200	16000	16800	ns
	right @0	BLKR0	BLKR: 0000	2700	3500	4200	ns
	right @15	BLKR15	BLKR: 1111	-1100	-300	500	ns
Sand castle pulse crest value	H	SANDH		5.3	5.6	5.9	V
	M1	SANDM1		3.7	4.0	4.3	V
	L	SANDL		0.1	0.4	0.7	V
Burst gate pulse	Width	BGPWD		3.5	4.0	4.5	µs
	Phase	BGPPH		4.9	5.4	5.9	µs
X-ray protection circuit operating voltage		VXRAY		0.64	0.69	0.74	V
Vertical screen size compensation							
Vertical ramp output amplitude	NTSC@64	Vsnt64	VSIZE: 1000000	0.75	0.85	0.95	Vp-p
	NTSC @0	Vsnt0	VSIZE: 0000000	0.40	0.50	0.60	Vp-p
	NTSC@127	Vsnt127	VSIZE: 1111111	1.05	1.20	1.35	Vp-p
Vertical size 0.75		VSEZE75	VSIZE0.75: 1	0.70	0.80	0.90	ratio
High-voltage dependent vertical size correction							
Vertical size correction @0		Vsizecomp	VCOMP: 000	0.83	0.93	0.97	ratio
Vertical screen position adjustment/linearity adjustment/S-shaped correction adjustment							
Vertical ramp DC voltage	NTSC@32	Vdcnt32	VDC: 100000	2.25	2.40	2.55	Vdc
	NTSC@0	Vdcpal0	VDC: 000000	1.85	2.00	2.15	Vdc
	NTSC@63	Vdcpal63	VDC: 111111	2.65	2.80	2.95	Vdc

Continued on next page.

LA76835NM

Continued from preceding page.

Parameter		Symbol	Conditions	Ratings			Unit
				min	typ	max	
Vertical linearity	@16	Vlint16	V.LIN_TOP: 10000	0.70	1.00	1.30	ratio
	@0	Vlint00	V.LIN_TOP: 00000	0.40	0.70	1.00	ratio
	@31	Vlint31	V.LIN_TOP: 11111	0.90	1.20	1.50	ratio
Vertical linearity BOTTOM	@16	Vlinb16	V.LIN_BOTTOM: 10000	0.70	1.00	1.30	ratio
	@0	Vlinb0	V.LIN_BOTTOM: 00000	0.40	0.70	1.00	ratio
	@31	Vlinb31	V.LIN_BOTTOM: 11111	0.90	1.20	1.50	ratio
Vertical S-shaped correction	@16	VScor16	VSC: 10000	0.73	0.88	1.03	ratio
	@0	VScor0	VSC: 00000	1.12	1.27	1.32	ratio
	@31	VScor31	VSC: 11111	0.49	0.64	0.79	ratio
Raster Cut	TOP	RASCUTT	Raster_cut: 1	59	64	69	line
	BOTTOM	RASCUTB	Raster_cut: 1	218	223	228	line
H Phase BOW	@8	HBOW8	H_Phase_BOW: 1000	-1300	-1000	-700	ns
	@0	HBOW0	H_Phase_BOW: 0000	-300	0	300	ns
	@15	HBOW15	H_Phase_BOW: 1111	700	1000	1300	ns
H Phase ANGLE	@8	HANG8	H_Phase_ANGLE: 1000	-1200	-900	-600	ns
	@0	HANG0	H_Phase_ANGLE: 0000	-300	0	300	ns
	@15	HANG15	H_Phase_ANGLE: 1111	600	900	1200	ns
HS/VS/VBLK							
HS output pulse width		PWHS		11.0	12.0	13.0	μs
VS output pulse width		PWVS		22.0	25.0	28.0	μs
Vertical Blanking period	@0	VBLK0	V_BLK_Select: 00	20	22	24	H
	@1	VBLK1	V_BLK_Select: 01	34	36	28	H
	@2	VBLK2	V_BLK_Select: 10	44	46	48	H
	@3	VBLK3	V_BLK_Select: 11	51	53	55	H
Horizontal screen size adjustment							
East/West DC Voltage	@32	EWdc32	EWDC: 100000	1.90	2.30	2.70	Vdc
	@0	Ewdc0	EWDC: 000000	0.90	1.30	1.70	Vdc
	@63	Ewdc63	EWDC: 111111	2.90	3.30	3.70	Vdc
High-voltage dependent horizontal size compensation							
Horizontal size compensation@0		Hsizecomp	HCOMP: 000	0.1	0.3	0.50	V
Pincushion correction							
East/West amplitude	@32	EWamp32	EWAMP: 100000	0.90	1.30	1.70	Vp-p
	@0	EWamp0	EWAMP: 000000	-0.40	0.00	0.40	Vp-p
	@63	EWamp63	EWAMP: 111111	2.20	2.60	3.00	Vp-p
Tilt Correction							
East/West tilt	@32	Ewtilt32	EWTLT: 100000	-0.40	0.00	0.40	V
	@0	EWtilt0	EWTLT: 000000	-1.40	-1.00	-0.6	V
	@63	EWtilt63	EWTLT: 111111	0.60	1.00	1.40	V
Corner Correction							
East/West corner	top	EWcorTOP	CORTOP: 1111-0000	0.30	0.70	1.10	V
	bottom	EWcorBOT	CORBOTTOM: 1111-0000	0.30	0.70	1.10	V

Continued on next page.

Package Dimensions

unit : mm

3174A

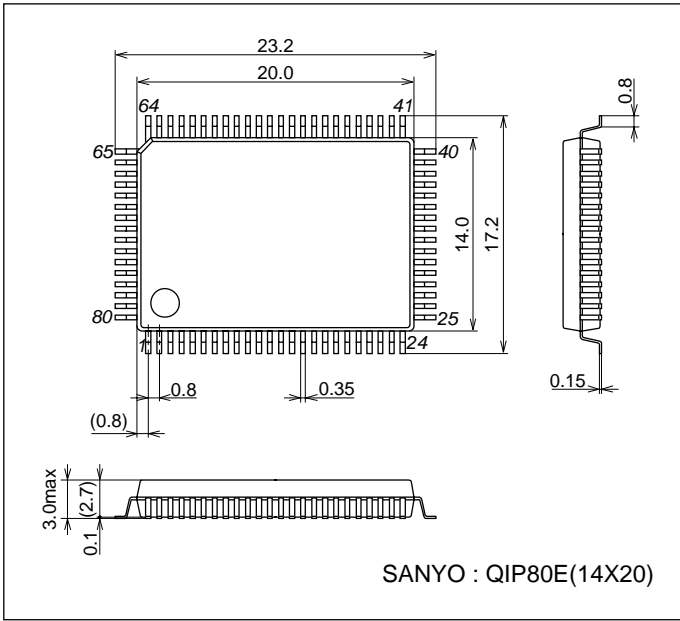

LA76835NM

Block Diagram and Application Circuit Example

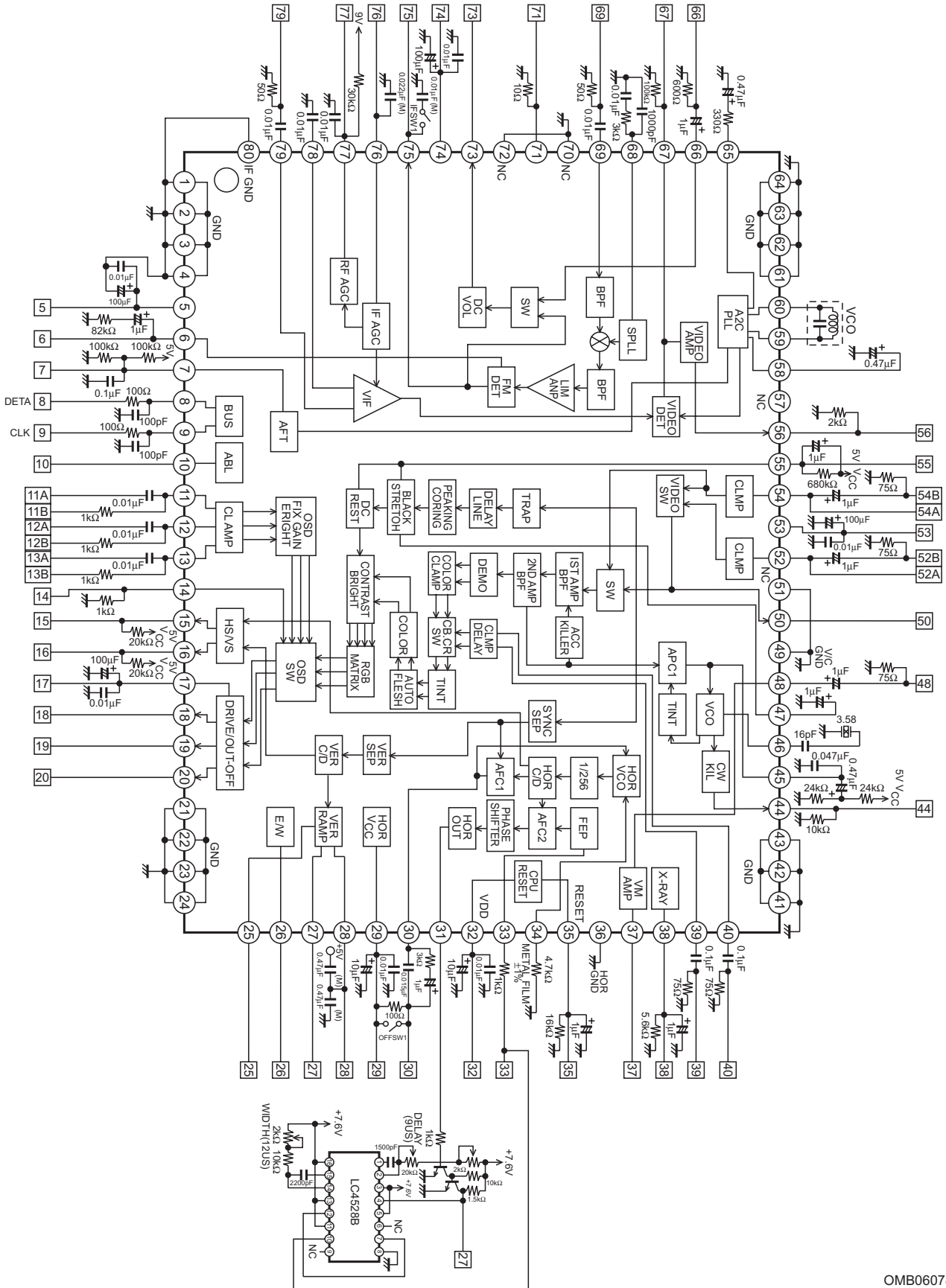

OMB06078

LA76835NM







Test Conditions $T_a = 25^\circ\text{C}$, $V_{CC1} = V_5 = V_{53} = 5.0\text{V}$, $V_{CC2} = V_{74} = 9.0\text{V}$, $I_{CC1} = I_{17} = 19\text{mA}$, $I_{CC2} = I_{29} = 29\text{mA}$

Circuit voltage, current

Parameter	Symbol	Test point	Input signal	Test method	Bus conditions
IF supply current (pin 5)	I_5	5	No signal	Apply a voltage of 5.0V to pin 5 and measure the incoming DC current [mA]. (IF AGC (76pin) 2.5V)	Initial
RGB supply voltage	V_{17}	17		Apply a current of 19mA to pin 17 and measure the voltage at pin 17.	Initial
Horizontal supply voltage	V_{29}	29		Apply a current of 29mA to pin 29 and measure the voltage at pin 29.	Initial
Video/vertical supply current	I_{53}	53		Apply a voltage of 5.0V to pin 53 and measure the incoming DC current [mA].	Initial
CPU Reset operation voltage	Vreset	35 32		Allow the current to flow slightly at a time through pin 32 and measure the pin 32 voltage at a time when the pin 35 voltage rises.	Initial
IF supply current (pin 74)	I_{74}	74	No signal	Apply a voltage of 9.0V to pin 74 and measure the incoming DC current [mA].	Initial

VIF Block Input Signals and Test Conditions

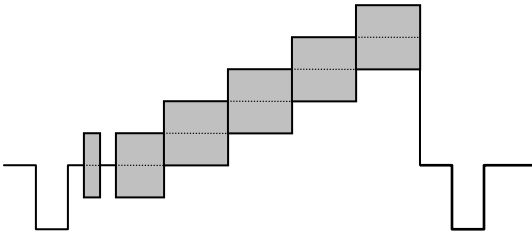
1. Input signals must all be input to the PIF IN (pin 79) in the Test Circuit.
2. All input signal voltage values are the levels at the VIF IN (pin 79) in the Test Circuit.
3. Pin 34 = 5V
4. Signal contents and signal levels.

Input signal	Waveform	Conditions
SG1		45.75MHz
SG2		42.17MHz
SG3		41.25MHz
SG4		Frequency variable
SG5		45.75MHz 87.5% Video Mod. 10-stairstep wave (Subcarrier: 3.58MHz)
SG6		45.75MHz $f_m = 15\text{kHz}$, AM = 78%

5. Before measurement, adjust the DAC as follows.

Parameter	Test point	Input signal	Adjustment
Video Level DAC	56	SG6, 80dB μ	Set the output level at pin 56 as close to 1.4Vp-p as possible.

LA76835NM

VIF Block Test Conditions

Input signal	Symbol	Test point	Input signal	Test method	Bus conditions
Maximum RF AGC voltage	VRFH	77	SG1 80dB μ	Measure the DC voltage at pin 77.	RF.AGC = "000000"
Minimum RF AGC voltage	VRFL	77	SG1 80dB μ	Measure the DC voltage at pin 77.	RF.AGC = "111111"
RF AGC Delay Pt	(@DAC = 0)	77	SG1	Obtain the input level at which the DC voltage at pin 77 becomes 4.5V.	RF.AGC = "000000"
	(@DAC = 63)			Obtain the input level at which the DC voltage at pin 77 becomes 4.5V.	RF.AGC = "111111"
Input sensitivity	Vi	56	SG6	Using an oscilloscope, observe the level at pin 56 and obtain the input level at which the waveform's p-p value becomes 1.0Vp-p.	
No-signal video output voltage	Von	56	No signal	Set IF AGC = "1" and measure the DC voltage at pin 56.	IF.AGC = "1"
Sync signal tip level	Votip	56	SG1 80dB μ	Measure the DC voltage at pin 56.	
Video output amplitude	Vo	56	SG6 80dB μ	Using an oscilloscope, observe the level at pin 56 and measure the waveform's p-p value.	
Video S/N	S/N	56	SG1 80dB μ	Measure the noise voltage at pin 56 with an RMS voltmeter through a 10kHz to 4.2MHz band-pass filter. Vsn 20Log (1.0/Vsn)	
C-S beat level	IC-S	56	SG1 SG2 SG3	Input a 80dB μ SG1 signal and measure the DC voltage (V76) at pin 76. Mix SG1 = 74dB μ , SG2 = 69dB μ , and SG3 = 49dB μ to enter the mixture in the VIF IN. Apply V76 to pin 76 from an external DC power supply. Using a spectrum analyzer, measure the difference between pin 56's 3.58MHz component and 920kHz component.	
Differential gain	DG	56	SG5 80dB μ	Using a vector scope, measure the level at pin 56.	
Differential phase	DP	56	SG5 80dB μ	Using a vector scope, measure the level at pin 56.	
Maximum AFT output voltage	VAFTH	7	SG4 80dB μ	Set and input the SG4 frequency to 44.75MHz. Measure the DC voltage at pin 7 at that moment.	
Minimum AFT output voltage	VAFTL	7	SG4 80dB μ z	Set and input the SG4 frequency to 46.75MHz. Measure the DC voltage at pin 7 at that moment.	
AFT detection sensitivity	VAFTS	7	SG4 80dB μ z	Adjust the SG4 frequency and measure frequency deviation Δf when the DC voltage at pin 7 changes from 1.5V to 3.5V. VAFTS = 2000/ Δf [mV/kHz]	
APC pull-in range (U), (L)	fPU, fPL	56	SG4 80dB μ	Connect an oscilloscope to pin 56 and adjust the SG4 frequency to a frequency higher than 45.75MHz to bring the PLL into unlocked mode. (A beat signal appears.) Lower the SG4 frequency and measure the frequency at which the PLL locks again. In the same manner, adjust the SG4 frequency to a lower frequency to bring the PLL into unlocked mode. Higher the SG4 frequency and measure the frequency at which the PLL locks again.	

SIF Block (FM block) Input Signals and Test Conditions

Unless otherwise specified, the following conditions apply when each measurement is made.

1. Bus control condition: IF.AGC. = "1", FM.MUTE = "0"
2. IFSW1 = "ON", pin 34 = 5V
3. Input signals are input to pin 69 and the carrier frequency is 4.5MHz.

Parameter	Symbol	Test point	Input signal	Test method	Bus conditions
FM detection output voltage	S _O ADJ	75	90dB μ , fm = 400Hz, FM = \pm 25kHz	Measure the FM detection output (400Hz component) of pin 75.	
FM limiting sensitivity	SLS	75	fm = 400Hz, FM = \pm 25kHz	Measure the input level (dB μ) at which the 400Hz component of the FM detection output at pin 75 becomes -3dB relative to SV1.	
FM detection output f characteristics (fm = 100kHz)	SF	75	90dB μ , fm = 100kHz FM = \pm 25kHz	Set IFSW1 = "OFF". Measure the FM detection output of pin 75. [mVrms] SF = 20Log (SV1/SV2) [dB]	
FM detection output distortion	STHD	75	90dB μ , fm = 400Hz, FM = \pm 25kHz	Measure the distortion factor of the 400Hz component of the FM detection output at pin 75.	
AM rejection ratio	SAMR	75	90dB μ , fm = 400Hz, AM = 30%	Measure the 400kHz component of the FM detection output at pin 75. SV3 [mVrms] Assign the measured value to SV3. SAMR = 20Log (SV1/SV2) [dB]	
SIF.S/N	SSN	75	90dB μ , CW	Measure the noise level (DIN AUDIO) at pin 75. SV4 [mVrms] SSN = 20Log(SV1/SV4) [dB]	
de-emphetime constant	SNTC	75	90dB μ , fm = 2.12kHz FM = \pm 25kHz	Measure the 2.12kHz component of the FM detection output at pin 75. SV5 [mVrms] SNTC = 20Log (SV1/SV5) [dB]	

Audio Block Input Signals and Test Conditions

Unless otherwise specified, the following conditions apply when each measurement is made.

1. Bus control condition:

AUDIO.MUTE = "0", AUDIO.SW = "1", VOL.FIL = "0", IF.AGC. = "1"

2. Input 4.5MHz, 90dB μ and CW at pin 69.

3. Pin 34 = 5V

4. Enter an input signal from pin 66.

Parameter	Symbol	Test point	Input signal	Test method	Bus conditions
Maximum gain	AGMAX	73	1kHz, CW 500mVrms	Measure the 1kHz component at the pin 73. V1 [mVrms] AGMAX = 20Log (V1/500) [dB]	VOLUME = "1111111"
Variable range	ARANGE	73	1kHz, CW 500mVrms	Measure the 1kHz component at the pin 73. V2 [mVrms] ARANGE = 20Log (V1/V2) [dB]	VOLUME = "0000000"
Frequency characteristics	AF	73	20kHz, CW 500mVrms	Measure the 20kHz component at the pin 73.V3 [mVrms] AF = 20Log (V3/V1) [dB]	VOLUME = "1111111"
Mute	AMUTE	73	1kHz, CW 500mVrms	Measure the 20kHz component at the pin 73.V4 [mVrms] AMUTE = 20Log (V1/V4) [dB]	VOLUME = "1111111" AUDIO.MUTE = "1"
Distortion	ATHD	73	1kHz, CW 500mVrms	Measure the distortion of the 1kHz component at the pin 73.	VOLUME = "1111111"
S/N	ASN	73	No signal	Measure the noise level (DIN AUDIO) at the pin 73.V5 [mVrms] ASN = 20Log (V1/V5) [dB]	VOLUME = "1111111"
Crosstalk	ACT	73	1kHz, CW 500mVrms	Measure the 1kHz component at the pin 73.V6 [mVrms] ACT = 20Log (V1/V6) [dB]	VOLUME = "1111111" AUDIO.SW = "0"

Chroma Block Input Signals and Test Conditions

Unless otherwise specified, the following conditions apply when each measurement is made.

1. VIF, SIF blocks: No signal
2. Y input to pin 52:
Unless otherwise specified, the deflector must be locked to the synchronous signal when the 0 (IRE) signal and the horizontal/vertical composite signal are entered.
3. C input: C IN (pin 54) input
4. Bus control conditions:
Set red and blue drives to DAC at which the Y-signal level of pins 18, 19 and 20 becomes as close to R = G = B as possible. Assume here that Gamma Def. is 1 (default), Video SW="1", and C.Ext="1". Set the following conditions unless otherwise specified.
5. Adjust an external X-tal of pin 46 so that the series capacity and resistor impedance (Z) become as follows:
Z=0deg @3.579545MHz±10Hz
-40±1deg@3.579545MHz
6. How to calculate the demodulation ratio and angle as follows:

B-Y axis angle = $\tan^{-1}(B(0)/B(270))+270^\circ$
 R-Y axis angle = $\tan^{-1}(R(180)/R(90))+90^\circ$
 G-Y axis angle = $\tan^{-1}(G(270)/G(180))+180^\circ$

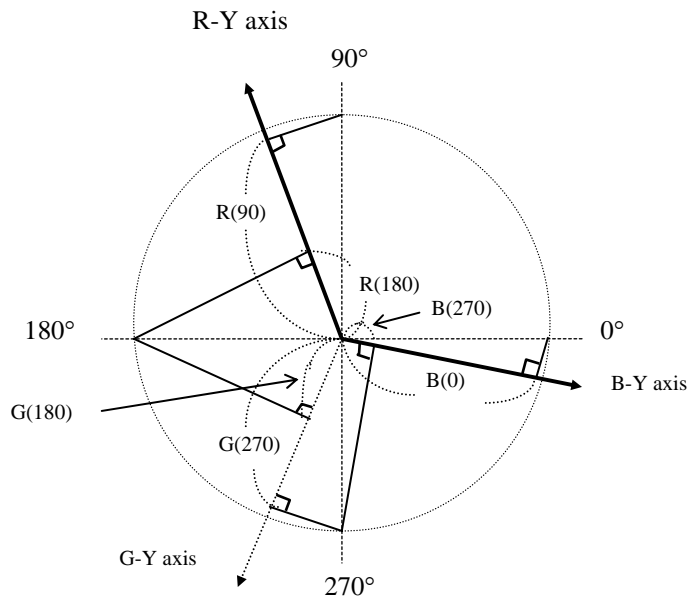

LA76835NM

Chroma input signal:

C-1

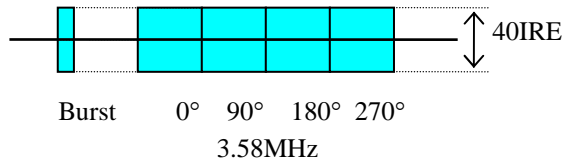

77IRE signal (L-77)

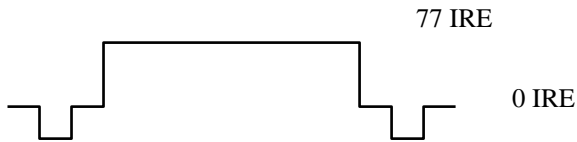

C-2

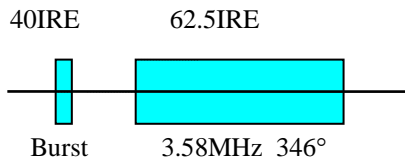

C-3

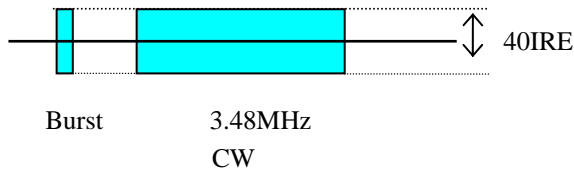

(If a frequency is specified, use the specified frequency.)

C-4

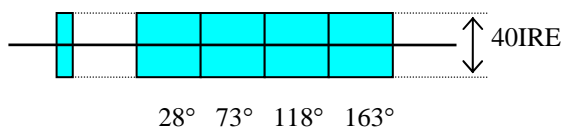

C-5

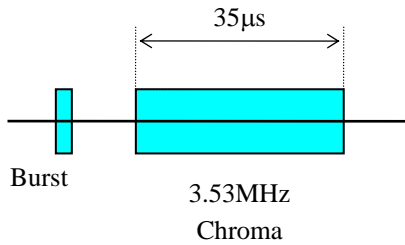

LA76835NM

Chroma Block Test Conditions

Parameter		Symbol	Test point	Input signal	Test method	Bus conditions
ACC amplitude characteristics	1	ACCM1	Bout <div style="border: 1px solid black; width: 20px; height: 20px; text-align: center; margin: 5px auto;">20</div>	C-1 0dB +6dB	Measure the output when 0dB is applied to the chroma input and the output amplitude when +6dB is applied to the chroma input and calculate the ratio between them. $ACCM1 = 20\text{Log} (+6\text{dBdata}/0\text{dBdata})$	
	2	ACCM2		C-1 -14dB	Measure the output when 0dB is applied to the chroma input and the output amplitude when -14dB is applied to the chroma input and calculate the ratio between them. $ACCM2 = 20\text{Log} (-14\text{dBdata}/0\text{dBdata})$	
B-Y/Y amplitude ratio		CLRBY	20	YIN: L77 No signal	Measure the Y system's output level. V1	
				C-2	Input a signal to the CIN (only sync signal to the YIN) and measure the output level. $CLRBY = 100 \times (V2/V1) + 15\%$	
Color control characteristics	1	CLRMM	20	C-3	Measure the output amplitude V1 at color control MAX mode and output amplitude V2 at color control NOM mode.: $CLRMM = V1/V2$	Color: 1111111 (Max) Color: 1000000 (NOM)
	2	CLRMM			Measure the output amplitude V3 at color control MIN mode. $CLRMM = 20\text{Log} (V1/V3)$	Color: 0000000 (Min)
Color control sensitivity		CLRSE	20	C-3	Measure the output amplitude V4 at color control 90 mode and output amplitude V5 at color control 38 mode. $CLRSE = 100 \times (V4-V5)/(V2 \times 52)$	Color: 1011010 Color: 0100110
Tint center		TINCEN	20	C-1	Measure each part of the output waveform and calculate the B-Y axis angle.	TINT: 1000000
Tint control	MAX	TINMAX	20	C-1	Measure each part of the output waveform and calculate the B-Y axis angle. $TINMAX = \text{B-Y axis angle} - TINCEN$	TINT: 1111111
	MIN	TINMIN			Measure each part of the output waveform and calculate the B-Y axis angle. $TINMIN = \text{B-Y axis angle} - TINCEN$	TINT: 0000000
Tint control sensitivity		TINSE	20	C-1	Measure the angle A1 at TINT control 85 mode and angle A2 at TINT control 42 mode. $TINSE = (A1-A2)/43$	TINT: 1010101 TINT: 0101010
Tint dependence on color	L	CLRPL	20	C-1	Measure the angle of B-Y axis with Color: 44 and determine CLRPL. $CLRPL = \text{B-Y axis angle} - TINCEN$	COLOR: 00101100
	H	CLRPH			Measure the angle of B-Y axis with Color: 84 and determine CLRPH. $CLRPH = \text{B-Y axis angle} - TINCEN$	COLOR: 01010100

Continued on next page.

LA76835NM

Continued from preceding page.

Parameter	Symbol	Test point	Input signal	Test method	Bus conditions
R-Y/B-Y Demodulation output ratio R-Y/B-Y	RB	18 19 20	YIN: L77 C-1: No signal YIN: 0 IRE C-3	Input a signal to YIN and adjust DAC in R and B drives so that the Y output levels at pins 18 and 20 become as close to the level at 19 as possible. (*1) After that, input 0 IRE to YIN and C-3 to CIN. Measure BOUT output amplitude Vb and ROUT output amplitude Vr and calculate $RB=Vr/Vb$.	Color: 1000000 Adjustment value in B and R drives: *1
Demodulation output ratio G-Y/B-Y	GB	19	C-3	Measure GOUT output amplitude Vg and calculate $GB = Vg/Vb$. For the R/B Drive, the adjustment value: *1 applies.	Color: 1000000 Adjustment value in B and R drives: *1
Demodulation angle R-Y/B-Y	ANGRB1	20 18	C-1	Measure each output level of the BOUT and ROUT and calculate the angles of the B-Y axis and R-Y axis. $ANGRB1 = (R-Y \text{ angle}) - (B-Y \text{ angle})$	
Demodulation angle R-Y/B-Y Control 1	ANGRB2	20 18	C-1	With R-Y/B-Y angle set at maximum, carry out the same measurement as for ANGRB1. $ANGRB2 = (R-Y \text{ angle}) - (B-Y \text{ angle})$	R-Y/B-Y angle 1111
Demodulation angle R-Y/B-Y Control 2	ANGRB3	20 18	C-1	With R-Y/B-Y angle set at minimum, carry out the same measurement as for ANGRB1. $ANGRB3 = (R-Y \text{ angle}) - (B-Y \text{ angle})$ Reset R-Y/B-Y angle to 1000.	R-Y/B-Y angle 0000
Demodulation angle G-Y/B-Y	ANGGB1	19	C-1	Measure each output level of the GOUT and calculate the angle of the G-Y axis. $ANGGB1 = (G-Y \text{ angle}) - (B-Y \text{ angle})$	
Demodulation angle G-Y/B-Y control	ANGGB2	19	C-1	Measure each output level of the GOUT and calculate the angle of the G-Y axis. $ANGGB2 = (G-Y \text{ angle}) - (B-Y \text{ angle})$	G-Y_Angle: 1
Killer operating point 2	KILL	20	C-3	Reduce the input signal until the output level becomes 50mVp-p or less. Measure the input level at that moment.	Filter Sys: 1 C. Bypass: 0 ColorKillerope.: 2
Killer operating point 4	KILL	20	C-3	Reduce the input signal until the output level becomes 50mVp-p or less. Measure the input level at that moment.	Filter Sys: 1 C. Bypass: 0 ColorKillerope.: 4
Killer operating point difference	D_KILL			$D_KILL = KILL - KILL4$	
Chroma VCO free-running frequency	CVCOF	44	CIN: No signal	Measure oscillation frequency f. $CVCOF = f - 3579545 \text{ (Hz)}$	
APC pull-in range (+)	PLINP0	20	C-1	Decrease the chroma fsc frequency from 3.579545MHz+1000Hz and measure the frequency at which the VCO locks.	
APC pull-in range (-)	PLINN0	20	C-1	Increase the chroma fsc frequency from 3.579545MHz-1000Hz and measure the frequency at which the VCO locks.	
Static phase error (+)	SPER_P	20	C-1	Set the fsc frequency to 3.579545MHz+200Hz, measure the B-Y axis angle. $SPER_P = B-Y \text{ axis angle} - TINCEN$	

Continued on next page.

LA76835NM

Continued from preceding page.

Parameter	Symbol	Test point	Input signal	Test method	Bus conditions
Static phase error (-)	SPER_N	20	C-1	Set the fsc frequency to 3.579545MHz-200Hz, measure the B-Y axis angle. SPER_N = B-Y axis angle-TINCEN	
fsc output amplitude	C_FSC	44	C-1	Measure 3.58MHz CW output amplitude at pin 44.	
Residual higher harmonic level B	E_CAR_B	20	C-1 Burst only	Measure the 7.16MHz component output amplitude at pin 20.	
Residual higher harmonic level R	E_CAR_R	Rout 18	Burst only	Measure the 7.16MHz component output amplitude at pin 18.	
Residual higher harmonic level G	E_CAR_G	Gout 19	C-1 Burst only	Measure the 7.16MHz component output amplitude at pin 19.	

Chroma BPF Block Test Conditions

Band-pass amplitude characteristic 3.08MHz	CBP308	20	C-3	Measure V5 output amplitude. Set the chroma frequency (CW) to 3.08MHz and measure V6 output amplitude. $CBE308 = 20\text{Log} (V6/V5)$	FILTER.SYS: 1 C.BYPASS: 0
Band-pass amplitude characteristic 3.88/3.28MHz	CBP03	20	C-3	Measure V7 output amplitude when the chroma frequency (CW) is 3.28MHz and V8 output amplitude when it (CW) is 3.88 MHz. $CBE = 20\text{Log} (V8/V7)$	FILTER.SYS: 1 C.BYPASS : 0
Band-pass amplitude characteristic 4.08/3.08MHz	CBP05	20	C-3	Set the chroma frequency (CW) to 4.08MHz and measure V9 output amplitude. $CBE05 = 20\text{Log} (V9/V6)$	FILTER.SYS: 1 C.BYPASS: 0

Video Block Input Signals and Test Conditions

Chroma input signal* chroma or burst signal: 40 IRE

Y input signal: 100IRE (714mV)

Bus control bit conditions: Initial test state

0IRE signal (L-0): NTSC standard sync signal

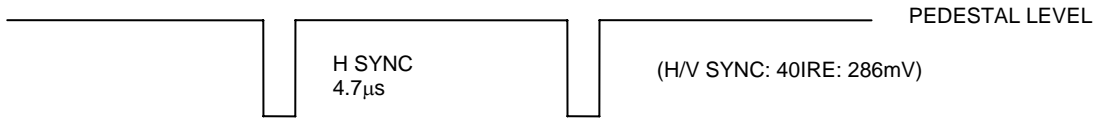

XIRE signal (L-X)



CW signal (L-CW)

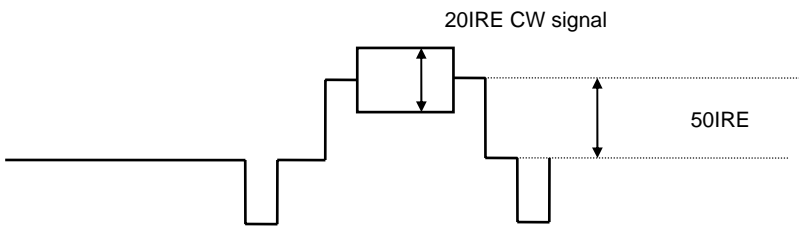

BLACK STRETCH 0IRE signal (L-BK)

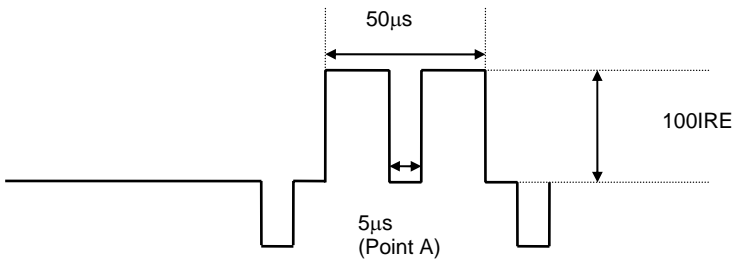

R/G/B IN Input signal

RGB Input signal 1 (0-1)

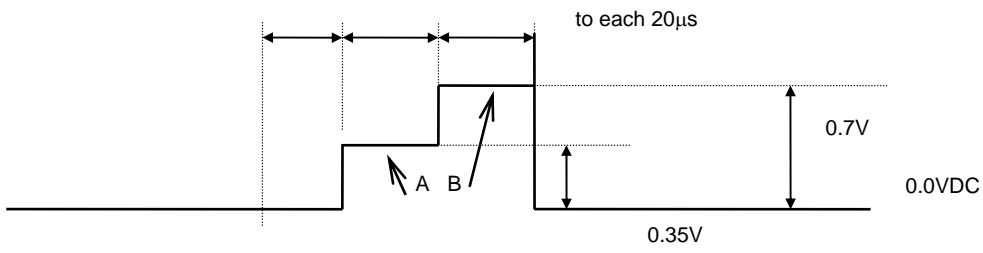

RGB Input signal 2 (0-2)

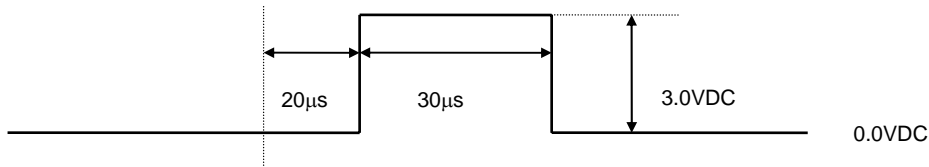

First conditions: Pin 10:5V, Pin 11: GND, Pin 12: GND, Pin 13: GND, Pin 14: GND.

LA76835NM

OSD Block Test Conditions

Parameter		Symbol	Test point	Input signal	Test method	Bus conditions
OSD Fast SW threshold		FSTH	20	L-0 O-2	Apply voltage to pin 14 and measure the voltage at pin 14 at the point where the output signal switches to the OSD signal.	Pin 13B: O-2 applied HT DEF:1
Digital OSD Red output amplitude @OSD	Cnt: 0	ROSDDIG0	18	L-50 L-0 O-2	Measure the output signal's 50IRE amplitude. CNTCR [Vp-p] Measure the OSD output amplitude.OSDHR [Vp-p] $ROSDDIG0 = 50 \times (OSDHR0 / CNTCR)$	Pin 14: 3.5V Pin 11: O-2 applied Pin 38: 5V Digital OSD: 1
	Cnt: 3	ROSDDIG3		L-50 L-0 O-2	Measure the output signal's 50IRE amplitude. CNTCR [Vp-p] Measure the OSD output amplitude. OSDHR3 [Vp-p] $ROSDDIG3 = 50 \times (OSDHR3 / CNTCR)$	Pin 14: 3.5V Pin 11B: O-2 applied Pin 38: 5V Digital OSD: 1 OSD Contrast: 3
Digital OSD Green output amplitude @OSD	Cnt: 0	GOSDDIG0	19	L-50 L-0 O-2	Measure the output signal's 50IRE amplitude.CNTCG [Vp-p] Measure the OSD output's amplitude.OSDHG0 [Vp-p] $GOSDDIG0 = 50 \times (OSDHG0 / CNTCG)$	Pin 14: 3.5V Pin 12B: O-2 applied Pin 38: 5V Digital OSD: 1
	Cnt: 3	GOSDDIG3		L-50 L-0 O-2	Measure the output signal's 50IRE amplitude.CNTCG [Vp-p] Measure the OSD output's amplitude.OSDHG3 [Vp-p] $GOSDDIG3 = 50 \times (OSDHG3 / CNTCG)$	Pin 14: 3.5V Pin 12B: O-2 applied Pin 38: 5V Digital OSD: 1 OSD Contrast: 3
Digital OSD Blue output amplitude @OSD	Cnt: 0	BOSDDIG0	20	L-50 L-0 O-2	Measure the output signal's 50IRE amplitude. CNTCB [Vp-p] Measure the OSD output's amplitude. OSDHB0 [Vp-p] With OSD contrast of 3, carry out the similar measurement. OSDHB3 [Vp-p] $BOSDC0 = 50 \times (OSDHB0 / CNTCB)$	Pin 14: 3.5V Pin 13B: O-2 applied Pin 38: 5V Digital OSD: 1
	Cnt: 3	BOSDDIG3		L-50 L-0 O-2	Measure the output signal's 50IRE amplitude. CNTCB [Vp-p] Measure the OSD output's amplitude. OSDHB3 [Vp-p] $BOSDC3 = 50 \times (OSDHB3 / CNTCB)$	Pin 14: 3.5V Pin 13B: O-2 applied Pin 38: 5V Digital OSD: 1 OSD Contrast: 3
Analog OSD R output amplitude gain match		RRGB	18	L-100 L-0 O-1	Measure the output signal's 50IRE amplitude. CNTHR [Vp-p] Measure the amplitudes at point B (0.7V portion of the input signal 0-1). Assign the measured values to (RGBHR [Vp-p]). $GRGB = RGBHG / CNTHG$	Pin 14: 3.5V Pin 11A: O-1 applied Pin 38: 5V OSD Contrast: 3

Continued on next page.

LA76835NM

Continued from preceding page.

Parameter	Symbol	Test point	Input signal	Test method	Bus conditions
Analog OSD G output amplitude gain match	GRGB	19	L-100 L-0 O-1	Measure the output signal's 100IRE amplitude. CNTHG [Vp-p] Measure the amplitudes at point B (0.7V portion of the input signal 0-1). Assign the measured values to (RGBHG [Vp-p]). GRGB = RGBHG/CNTHG	Pin 14: 3.5V Pin 12A: O-1 applied Pin 38: 5V OSD Contrast: 3
Analog OSD B output amplitude gain match	BRGB	20	L-100 L-0 O-1	Measure the output signal's 100IRE amplitude. CNTHB [Vp-p] Measure the amplitudes at point B (0.7V portion of the input signal 0-1). Assign the measured values to (RGBHB [Vp-p]). BRGB = RGBHB/CNTHB	Pin 14: 3.5V Pin 13A: O-1 applied Pin 38: 5V OSD Contrast: 3

[RGB Output Block] (Cutoff, Drive Block) Test Conditions

Brightness control	Normal	BRT64	18 19 20	L-0	Measure the 0IRE DC levels of the respective output signals of R output (18), G output (19), and B output (20). Assign the measured values to BRTPCR, BRTPCG, and BRTPCB V, respectively. $BRT63 = (BRTPCR+BRTPCG+BRTPCB)/3$	Brightness: 01111111
	Max	BRT127	20		Measure the 0IRE DC level of the output signal of B output (20) and assign the measured value to BRTPHB. $BRT127 = 50 \times (BRTPHB - BRTPCB) / CNTCB$	Brightness: 11111111
	Min	BRT0			Measure the 0IRE DC level of the output signal of B output (20) and assign the measured value to BRTPLB. $BRT0 = 50 \times (BRTPLB - BRTPCB) / CNTCB$	Brightness: 00000000
Bias (cutoff) control	Min	Vbias0	18 19 20	L-50	Measure the 0IRE DC levels (Vbias0 [V]) of the respective output signals of R output (18), G output (19), and B output (20). *: R, G, and B	
	Max	Vbias255			Measure the 0IRE DC levels (Vbias255 [V]) of the respective output signals of R output (18), G output (19), and B output (20). *: R, G, and B	Red/Green/Blue Bias: 11111111
Bias (cutoff) control resolution		Vbiassns	18 19 20		Measure the 0IRE DC levels (BAS80 [V]) of the respective output signals of R output (18), G output (19), and B output (20). *: R, G, and B Measure the 0IRE DC levels (BAS48 [V]) of the respective output signals of R output (18), G output (19), and B output (20). $Vbiassns^* = (BAS80^* - BAS48^*) / 32$	Red/Green/Blue Bias: 01010000 Red/Green/Blue Bias: 00110000

Continued on next page.

LA76835NM

Continued from preceding page.

Parameter	Symbol	Test point	Input signal	Test method	Bus conditions
Sub-bias control resolution	Vsbiassns	<div style="border: 1px solid black; width: 30px; height: 30px; margin: 5px; text-align: center; line-height: 30px;">18</div> <div style="border: 1px solid black; width: 30px; height: 30px; margin: 5px; text-align: center; line-height: 30px;">19</div> <div style="border: 1px solid black; width: 30px; height: 30px; margin: 5px; text-align: center; line-height: 30px;">20</div>	L-50	Measure the 0IRE DC levels (SBTPM [V]) of the respective output signals of R output (18), G output (19), and B output (20). *: R, G, B $Vsbiassns^* = (BRTPC^* - SBTPM^*)$	Sub-Brightness: 0101010
Drive adjustment maximum output 50IRE.	Rbout64 Gout10	<div style="border: 1px solid black; width: 30px; height: 30px; margin: 5px; text-align: center; line-height: 30px;">18</div> <div style="border: 1px solid black; width: 30px; height: 30px; margin: 5px; text-align: center; line-height: 30px;">19</div> <div style="border: 1px solid black; width: 30px; height: 30px; margin: 5px; text-align: center; line-height: 30px;">20</div>	L-100	Measure the 50IRE amplitudes (DRVM [Vp-p]) of the respective output signals of R output (18) and B output (20). *: R and B Measure the 50IRE amplitude of the output signal of G output (19) and assign the measured value to (DRVM [Vp-p]). *: G	
Output attenuation	DrGainRB DrGainG	<div style="border: 1px solid black; width: 30px; height: 30px; margin: 5px; text-align: center; line-height: 30px;">18</div> <div style="border: 1px solid black; width: 30px; height: 30px; margin: 5px; text-align: center; line-height: 30px;">19</div> <div style="border: 1px solid black; width: 30px; height: 30px; margin: 5px; text-align: center; line-height: 30px;">20</div>		Measure the 50IRE amplitudes (DRVL [Vp-p]) of the respective output signals of R output (18), and B output (20). *: R and B Measure the 50IRE amplitude of the output signal of G output (19) and assign the measured value to (DRVL [Vp-p]). *: G $DrGainRB^* = 20\text{Log} (DRVH^*/DRVL^*)$ $DrGainG^* = 20\text{Log} (DRVH^*/DRVL^*)$	Red/Blue Drive: 0000000 Green Drive: 0000
Drive adjustment maximum output 50IRE.	Rbout127 Gout15	<div style="border: 1px solid black; width: 30px; height: 30px; margin: 5px; text-align: center; line-height: 30px;">18</div> <div style="border: 1px solid black; width: 30px; height: 30px; margin: 5px; text-align: center; line-height: 30px;">19</div> <div style="border: 1px solid black; width: 30px; height: 30px; margin: 5px; text-align: center; line-height: 30px;">20</div>	L-100	Measure the 50IRE amplitudes (DRVH [Vp-p]) of the respective output signals of R output (18) and B output (20). *: R and B Measure the 50IRE amplitude of the output signal of G output (19) and assign the measured value to (DRVH [Vp-p]). *: G	Red/Blue Drive: 1111111 Green Drive: 1111
RGB output difference voltage	RGB_DC	<div style="border: 1px solid black; width: 30px; height: 30px; margin: 5px; text-align: center; line-height: 30px;">18</div> <div style="border: 1px solid black; width: 30px; height: 30px; margin: 5px; text-align: center; line-height: 30px;">19</div> <div style="border: 1px solid black; width: 30px; height: 30px; margin: 5px; text-align: center; line-height: 30px;">20</div>		Measure the 0IRE DC level (*_DC Vdc) of the output signal of R (18), G (19), and B (20) outputs.	

LA76835NM

VIDEO SW Block Test Conditions

Parameter	Symbol	Test point	Input signal	Test method	Bus conditions
Video signal input 1DC voltage	VIN1DC	52	L-100	Input signals to pin 52 and measure the voltage of the pedestal.	VIDEO SW: 1
Video signal input 1AC voltage	VIN1AC	52		Pin 52 recommended input level.	
Video signal input 2DC voltage	VIN2DC	54	L-100	Input signals to pin 54 and measure the voltage of the pedestal.	VIDEO SW: 0
Video signal input 2AC voltage	VIN2AC	54		Pin 54 recommended input level.	
SVO terminal DC voltage	SVODC	50	L-100	Input signals to pin 52 and measure the voltage of the pedestal at pin 50.	VIDEO SW: 1
SVO terminal AC voltage	SVOAC	50	L-100	Input signals to pin 52 and measure the voltage of the pedestal at pin 50.	VIDEO SW: 1

LA76835NM

Video Block Test Conditions

Parameter		Symbol	Test point	Input signal	Test method	Bus conditions
Video overall gain (Contrast max)		CONT127	20	L-50	Measure the output signal's 50IRE amplitude. CNTHB [Vp-p] CONT127 = 20Log (CNTHB/0.357)	CONTRAST: 1111111
Contrast adjustment characteristics	Normal/max	CONT90	20	L-50	Measure the output signal's 50IRE amplitude. CNTCB [Vp-p] CONT63 = 20Log (CNTCB/0.357)	
	Min/max	CONT0			Measure the output signal's 50IRE amplitude. CNTLB [Vp-p] CONT0 = 20Log (CNTLB/0.357)	
Video frequency Characteristics	1	BW1	20	L-CW	With the input signal's continuous wave = 100kHz, measure the output signal's continuous wave amplitude. PEAKDC [Vp-p] With the input signal's continuous wave = 7MHz, measure the output signal's continuous wave amplitude.CW1.4 [Vp-p] BW1 = 20Log (CW1.4/PEAKDC)	FILTER SYS: 000 SHARPNESS: 000000
	2	BW2			With the input signal's continuous wave = 1.8MHz, measure the output signal's continuous wave amplitude.CW1.8 [Vp-p] BW2 = 20Log (CW1.8/PEAKDC)	FILTER SYS: 010 SHARPNESS: 000000
	3	BW3			With the input signal's continuous wave = 3.4MHz, measure the output signal's continuous wave amplitude.CW3.4 [Vp-p] BW3 = 20Log (CW3.4/PEAKDC)	FILTER SYS: 100 SHARPNESS: 000000
Chroma trap amount		Ctrap	20	L-CW	With the input signal's continuous wave = 3.58MHz, measure the output signal's continuous wave amplitude.F00 [Vp-p] CtraP = 20Log (F00/PEAKDC)	FILTER SYS: 000 Sharpness: 000000
DC transmission amount	1	ClampG1	20	L-0	Measure the output signal's 0IRE DC level.BRTPL [V]	Brightness: 0000000 CONTRAST: 1111111
				L-100	Measure the output signal's 0IRE DC level (DRVPH [V]) and 100IRE amplitude (DRVH [Vp-p]) ClampG = 100×(1+(DRVPH - BRTPL)/DRVH) (PIN55: 3V)	Brightness: 0000000 CONTRAST: 1111111 DCREST = 00 BLK.ST.DEF = 1 WPL = 0
	2	ClampG2		With DCREST = 01, carry out measurement similarly to the case of the DC transmission amount 1. (PIN55: 3V)	DC.rest. = 01	
	3	ClampG3		With DCREST = 10, carry out measurement similarly to the case of the DC transmission amount 1. (PIN55: 3V)	DC.rest = 10	
	4	ClampG4	With DCREST = 11, carry out measurement similarly to the case of the DC transmission amount 1. (PIN55: 3V)	DC.rest = 11		

Continued on next page.

LA76835NM

Continued from preceding page.

Parameter		Symbol	Test point	Input signal	Test method	Bus conditions
Y-DL TIME	TRAP1	TdY1	20	L-50	Obtain the time difference (the delay time) from when the rise of the input signal's 501RE amplitude to the output signal's 501RE amplitude.	Filter Sys: 000
	TRAP2	TdY2			Obtain the time difference (the delay time) from when the rise of the input signal's 501RE amplitude to the output signal's 501RE amplitude.	Filter Sys: 010
	TRAP OFF	TdY3			Obtain the time difference (the delay time) from when the rise of the input signal's 501RE amplitude to the output signal's 501RE amplitude.	Filter Sys: 100
Pre-Shoot control	1	PreShoot1	20	L-100	Measure the pre-shoot width (Tpre) and over-shoot width (Tover) at rise of 100IRE amplitude of the output signal PreShoot = Tpre/Tover.	Pre-shoot adj.= 00 Filter Sys: 000 Sharpness= 111111
	2	PreShoot2			With Pre-shoot adj. = 11, carry out the same measurement as for the case of Pre-Shoot 1.	Pre-shoot adj.= 11 Filter Sys: 000 Sharpness= 111111
Black stretch gain	MAX	BKSTmax	20	L-BK	Measure the 0IRE DC level at point A of the output signal in the Black Stretch Defeat (Black Stretch OFF) mode. BKST1 [V] Measure the 0IRE DC level at point A of the output signal in the Black Stretch ON mode. (PIN55: 3V)BKST2 [V] BKSTmax = 50×(BKST1-BKST2)/CNTHB	Blk.str.gain = 10 Blk.str.start = 01 Blk Str def = 0 DC.rest = 00
	MID	BKSTmid			With Blk.str.gain = 01, carry out the same measurement as for the case of black stretch gain (MAX). (PIN55: 3V)	Blk.str.gain = 01 Blk.str.start = 01 Blk Str def = 0 DC.rest = 00
	MIN	BKSTmin			With Blk.str.gain = 00, carry out the same measurement as for the case of black stretch gain (max). (PIN55: 3V)	Blk.str.gain = 00 Blk.str.start = 01 Blk Str def = 0 DC.rest = 00
Black stretch start	60IRE ΔBlack	BSTTHmax	20	L-60	Measure the DC level at 60IRE of the output signal in the Black Stretch ON mode. (PIN55: 3V)BKST3 [V] Measure the 60IRE DC level of the output signal in the Black Stretch Defeat (Black Stretch OFF) mode.BKST4 [V] BKSTTHmax = 50×(BKST4-BKST3)/CNTHB	Blk.str.gain = 01 Blk.str.start = 10 Blk Str .def = 0 DC.rest = 00
	250IRE ΔBlack	BKSTTHmid		L-50	Measure the 50IRE DC level of the output signal in the Black Stretch Defeat ON mode. (PIN55: 3V)BKST5 [V] Measure the 50IRE DC level of the output signal in the Black Stretch Defeat (Black Stretch OFF) mode.BKST6 [V] BKSTTHmid = 50×(BKST6-BKST5)/CNTHB	Blk.str.gain = 01 Blk.str.start = 01 Blk Str .def = 0 DC.rest = 00
	340IRE ΔBlack	BKSTTHmin		L-40	Measure the 40IRE DC level of the output signal in the Black Stretch Defeat ON mode. (PIN55: 3V)BKST7 [V] Measure the 40IRE DC level of the output signal in the Black Stretch Defeat (Black Stretch OFF) mode.BKST8 [V] BKSTTHmin = 50×(BKST8-BKST7)/CNTHB	Blk.str.gain = 01 Blk.str.start = 00 Blk Str .def = 0 DC.rest = 00

Continued on next page.

LA76835NM

Continued from preceding page.

Parameter		Symbol	Test point	Input signal	Test method	Bus conditions
Sharpness variable range	Trap1	Sharp32T1	20	L-CW	With the input signal's continuous wave = 2.2MHz, measure the output signal's continuous wave amplitude. F01S32 [Vp-p] Sharp32T1 = 20Log (F01S32/PEAKDC)	FILTER SYS: 000 Sharpness: 100000
	Max	Sharp63T1			With the input signal's continuous wave = 2.2MHz, measure the output signal's continuous wave amplitude. F01S63 [Vp-p] Sharp63T1 = 20Log (F01S63/PEAKDC)	FILTER SYS: 000 Sharpness: 111111
	Min	Sharp0T1			With the input signal's continuous wave =2.2MHz, measure the output signal's continuous wave amplitude. F01S0 [Vp-p] Sharp0T1 = 20Log (F01S0/PEAKDC)	FILTER SYS: 000 Sharpness: 000000
Sharpness variable range	Trap2	Sharp32T2	20	L-CW	With the input signal's continuous wave=3MHz, measure the output signal's continuous wave amplitude. F02S32 [Vp-p] Sharp32T3 = 20Log (F02S32/PEAKDC)	Filter Sys: 010 Sharpness: 100000
	Max	Sharp63T2			With the input signal's continuous wave=3MHz, measure the output signal's continuous wave amplitude. F02S63 [Vp-p] Sharp63T2 = 20Log (F02S63/PEAKDC)	Filter Sys:010 Sharpness: 111111
	Min	Sharp0T2			With the input signal's continuous wave = 3MHz, measure the output signal's continuous wave amplitude. F02S0 [Vp-p] Sharp0T2 = 20Log (F02S0/PEAKDC)	Filter Sys: 010 Sharpness: 000000
Sharpness variable range	Trap3	Sharp32T3	20	L-CW	With the input signal's continuous wave=3MHz, measure the output signal's continuous wave amplitude. F03S32 [Vp-p] Sharp32T3 = 20Log (F03S32/PEAKDC)	Filter Sys:100 Sharpness: 100000
	Max	Sharp63T3			With the input signal's continuous wave = 3MHz, measure the output signal's continuous wave amplitude. F03S63 [Vp-p] Sharp63T3 = 20Log (F03S63/PEAKDC)	Filter Sys: 100 Sharpness: 111111
	Min	Sharp0T3			With the input signal's continuous wave = 3MHz, measure the output signal's continuous wave amplitude. F03S0 [Vp-p] Sharp0T3 = 20Log (F03S0/PEAKDC)	Filter Sys: 100 Sharpness: 000000
White peak limiter operating point	1	WPL1	20	L-100	Prepare the signal that enables change of APL and set APL = 10%. Increase the input signal and measure the input signal level at which the output is clipped. (PIN55: 2.5V)	WPL = 0 DC.rest = 0
	2	WPL2			Prepare the signal that enables change of APL and set APL = 100%. Increase the input signal and measure the input signal level at which the output is clipped. (PIN55: 2.5V)	WPL = 1 DC.rest = 0
	3	WPL3			Prepare the signal that enables change of APL and set APL = 100%. Increase the input signal and measure the input signal level at which the output is clipped. (PIN55: 2.5V)	WPL = 2 DC.rest = 0
	4	WPL4			Prepare the signal that enables change of APL and set APL = 100%. Increase the input signal and measure the input signal level at which the output is clipped. (PIN55: 2.5V)	WPL = 3 DC.rest = 0

Continued on next page.

LA76835NM

Continued from preceding page.

Parameter		Symbol	Test point	Input signal	Test method	Bus conditions
Y gamma effective point	1	YG1	20	L-100	Measure the output amplitude (0 to 100 IR) when Y GAMMA is 0. After that, set Y GAMMA to 1 and measure the output amplitude (0 to 100 IR). This is GAM1. Calculate YG1 with the formula $YG1 = GAM1/GAM0 * 100$.	
	2	YG2			Measure the output amplitude (0 to 100 IR) when Y GAMMA is 0. After that, set Y GAMMA to 2 and measure the output amplitude (0 to 100 IR). This is GAM2. Calculate YG1 with the formula $YG2 = GAM2/GAM0 * 100$.	
	3	YG3			Measure the output amplitude (0 to 100 IR) when Y GAMMA is 0. After that, set Y GAMMA to 3 and measure the output amplitude (0 to 100 IR). This is GAM3. Calculate YG3 with the formula $YG3 = GAM3/GAM0 * 100$.	
GRAY MODE LEVEL		GRAY	20		Measure the DC level (deviation from pedestal) of pin20, and transfer IRE.	GRAY.MODE = 1 CROSS.B/W = 2
Horizontal/vertical blanking output level		RGBBLK	20	L-100	Measure the DC level for the output signal's blanking period. RGBBLK [V]	

Deflection Block Input Signals and Test Conditions

Unless otherwise specified, the following conditions apply when each measurement is made.

1. VIF, SIF blocks: No signal
2. C input: No. signal
3. Sync input: A horizontal/vertical composite sync signal

NTSC: 40IRE, horizontal sync signal (15.734264kHz) and vertical sync signal (59.94kHz)

Note: No burst signal, chroma signal shall exist below the pedestal level.

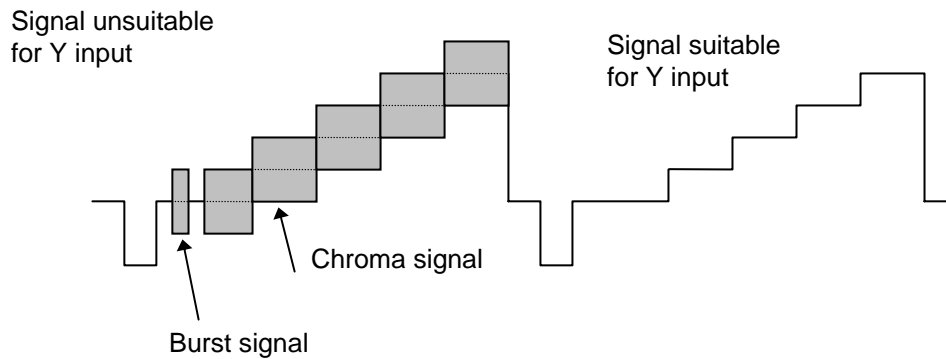

4. Bus control conditions: Initial conditions unless otherwise specified.
5. The delay time from the rise of the horizontal output (pin 31 output) to the fall of the FBP IN (pin 33 input) is $9\mu\text{s}$.
6. Pin 25 (vertical size correction circuit input terminal) is connected to V_{CC} (5.0V).

LA76835NM

Deflection Block Test Conditions

Parameter		Symbol	Test point	Input signal	Test method	Bus conditions
Horizontal free-running frequency		fH	31	Y IN: No signal	Connect a frequency counter to the output of pin 31 (H out) and measure the horizontal free-running frequency.	
Horizontal pull-in range		fH PULL	52	Y IN: Horizontal/ vertical sync signal	Using an oscilloscope, monitor the horizontal sync signal which is input to the Y IN (pin 52) and the pin 31 output (H out) and vary the horizontal signal frequency to measure the pull-in range.	
Horizontal output pulse length		Hduty	31	Y IN: Horizontal/ vertical sync signal	Measure the voltage for the pin 31 horizontal output pulse's low-level period.	
Horizontal output pulse saturation voltage		V Hsat	31	Y IN: Horizontal/ vertical sync signal	Measure the voltage for the pin 31 horizontal output pulse's low-level period.	
Horizontal AFC control current	M	HAFCM	30	Y IN: Horizontal/ vertical sync signal	Measure the current incoming into pin 30 horizontal AFC filter.	AFCGAIN: 0
	H	HAFCH		Measure the current incoming into pin 30 horizontal AFC filter.	AFCGAIN: 1	
	L	HAFCL		Y IN: No signal	Measure the current incoming into pin 30 horizontal AFC filter.	AFCGAIN: 0
Horizontal output pulse		HPHCEN	31 52	Y IN: Horizontal/ vertical sync signal	Measure the delay time T from the rise of the pin 31 horizontal output pulse to the fall of the Y IN horizontal sync signal. $\text{HPHCEN (ns)} = (T - 9.0\mu\text{s}) \times 1000$	
Horizontal position adjustment range		HPHrange	31 52	Y IN: Horizontal/ vertical sync signal	With H PHASE set at 0, 16, and 31, measure the delay time from the rise of the pin 31 horizontal output pulse to the fall of the Y IN horizontal sync signal and measure the adjustment range. (Determine the difference from HPHASE16.)	H PHASE: 00000 H PHASE: 11111

Continued on next page.

LA76835NM

Continued from preceding page.

Input signal	Symbol	Test point	Input signal	Test method	Bus conditions
Horizontal position adjustment maximum variable width	HPHstep	31 52	Y IN: Horizontal/vertical sync signal	<p>With H PHASE: 0 to 31 varied, measure the delay time from the rise of the pin 31 horizontal output pulse to the fall of the Y IN horizontal sync signal and calculate the variation at each step. Retrieve data for maximum variation.</p>	H PHASE: 00000 to H PHASE: 11111
Horizontal 2nd AFC pull-in range (min)	HPMIN	31 52	Y IN: Horizontal/vertical sync signal	<p>Measure the delay time from the rise of the pin 31 horizontal output pulse to the fall of the Y IN horizontal sync signal. Note that the delay time from the rise of horizontal output (pin 31 output) to the rise of F.B.P IN (pin 33 input) is assumed to be 0μs.</p>	
Horizontal 2nd AFC pull-in range (max)	HPMAX	31 52	Y IN: Horizontal/vertical sync signal	<p>Measure the delay time from the rise of the pin 31 horizontal output pulse to the fall of the Y IN horizontal sync signal. Note that the delay time from the rise of horizontal output (pin 31 output) to the rise of F.B.P IN (pin 33 input) is assumed to be 20μs.</p>	
Vertical free-running frequency	VFR60	27	Y IN: No signal	<p>Measure the cycle T of pin 27 vertical output.</p> <p>1/THz</p>	
Vertical pull-in range	fVPULL	27	Y IN: Horizontal/vertical sync signal	<p>Using an oscilloscope, monitor the vertical ysync signal which in input to the Y IN (pin 52) and then pin 27 output (V out) and vary the vertical signal frequency to measure the pull-in range. (Horizontal sync frequency: 15734 Hz)</p>	
Horizontal output stop voltage	Hstop	29 31	Y IN: Horizontal/vertical sync signal	<p>Decrease the current from a source connected to pin 29 and measure the pin 29 voltage at which HOUT stops.</p>	

Continued on next page.

LA76835NM

Continued from preceding page.

Input signal	Symbol	Test point	Input signal	Test method	Bus conditions
Horizontal blanking left variable range	@0	BLKL0	Y IN: Horizontal/ vertical sync signal	Measure the time T from the left end of Hsync at pin 52 Y IN to the left end of blanking at pin 20 Blue OUT with BLKL = 0000. 	BLKL: 0000
	@15	BLKL15		Measure the time T from the left end of Hsync at pin 52 Y IN to the left end of blanking at pin 20 Blue OUT with BLKL = 1111. 	BLKL: 1111
Horizontal blanking right variable range	@0	BLKR0	Y IN: Horizontal/ vertical sync signal	Measure the time T from the left end of Hsync at pin 52 Y IN to the left end of blanking at pin 20 Blue OUT with BLKR = 0000. 	BLKR: 0000
	@15	BLKR15		Measure the time T from the left end of Hsync at pin 52 Y IN to the left end of blanking at pin 20 Blue OUT with BLKR = 1111. 	BLKR: 1111

Continued on next page.

LA76835NM

Continued from preceding page.

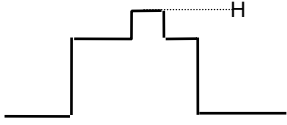
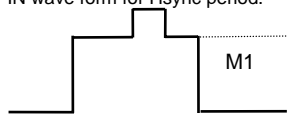
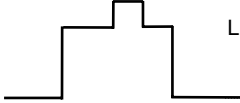
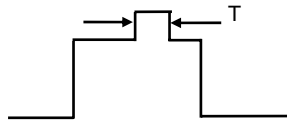
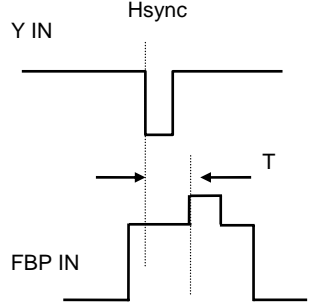
Input signal		Symbol	Test point	Input signal	Test method	Bus conditions
Sand castle pulse crest value	H	SANDH	33	Y IN: Horizontal/ vertical sync signal	Measure the supply voltage at point H of the pin 33 FBP IN wave form for Hsync period. 	
	M1	SANDM1			Measure the supply voltage at point M1 of the pin 33 FBP IN wave form for Hsync period. 	
	L	SANDL			Measure the supply voltage at point L of the pin 33 FBP IN wave form for Hsync period. 	
Burst gate pulse length	BGPWD		33	Y IN: Horizontal/ vertical sync signal	Measure the BGP width T of the pin 33 FBP IN wave form for Hsync period. 	
Burst gate pulse I phase	BGPPH		33 52	Y IN: Horizontal/ vertical sync signal	Measure the time from the left end of Hsync at pin 52 Y IN to the left end of the pin 33 FBP IN wave form for Hsync period. 	
X-ray protection circuit operating voltage	VXRAY		31 38	Y IN: Horizontal/ vertical sync signal	Connect a DC power supply to pin 38 and gradually increase the voltage from 0V until the pin 31 horizontal output pulse ceases. Measure the DC voltage at pin 38 at that moment.	

LA76835NM

Vertical Screen Size Correction

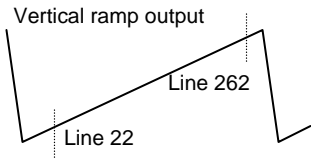
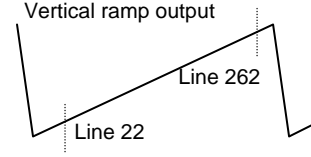
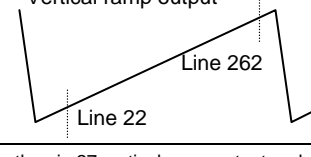
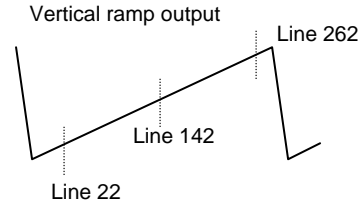
Input signal	Symbol	Test point	Input signal	Test method	Bus conditions
Vertical ramp output amplitude	@64	Vsnt64	Y IN: Horizontal/ vertical sync signal	Monitor the pin 27 vertical ramp output and measure the voltage at line 22 and line 262. $Vsnt64 = Vline262 - Vline22$ 	
	@0	Vsnt0		Monitor the pin 27 vertical ramp output and measure the voltage at line 22 and line 262. $Vsnt0 = Vline262 - Vline22$ 	VSIZE: 0000000
	@127	Vsnt127		Monitor the pin 27 vertical ramp output and measure the voltage at line 22 and line 262. $Vsnt127 = Vline262 - Vline22$ 	VSIZE: 1111111
Vertical size 0.75	VSIZE75	27	Y IN: Horizontal/ vertical sync signal	Monitor the pin 27 vertical ramp output and measure the voltage at line 22, line 262. $VSIZE75 = (Vline262 - Vline22) / Vsnt64$ 	VSIZE0.75: 1

LA76835NM

High-voltage Dependent Vertical Size Correction

Input signal	Symbol	Test point	Input signal	Test method	Bus conditions
Vertical size correction @0	Vsizecomp	27	Y IN: Horizontal/ vertical sync signal	Monitor the pin 27 vertical ramp output and measure the voltage at the line 22 and line 262 with VCOMP = 000. $V_a = V_{line262} - V_{line22}$ Apply 4.0V to pin 25 and measure the voltage at the line 22 and line 262 again. $V_b = V_{line262} - V_{line22}$ $V_{sizecomp} = V_b / V_a$	VCOMP: 000

Vertical Screen Position Adjustment

Input signal	Symbol	Test point	Input signal	Test method	Bus conditions
Vertical ramp DC voltage	@32	Vdcnt32	Y IN: Horizontal/ vertical sync signal	Monitor the pin 27 vertical ramp output and measure the voltage at line 142.	
	@0	Vdcnt0		Monitor the pin 27 vertical ramp output and measure the voltage at line 142.	VDC: 000000
	@63	Vdcnt63		Monitor the pin 27 vertical ramp output and measure the voltage at line 142.	VDC: 111111

Continued on next page.

LA76835NM

Continued from preceding page.

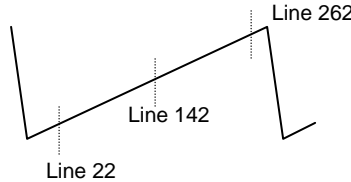
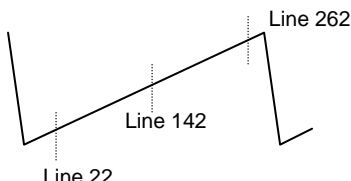
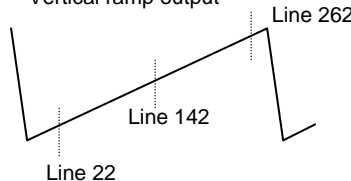
Input signal	Symbol	Test point	Input signal	Test method	Bus conditions
Vertical linearity TOP	@16	Vlint16	<div style="border: 1px solid black; width: 20px; height: 20px; display: flex; align-items: center; justify-content: center;">27</div> Y IN: Horizontal/ vertical sync signal	Monitor the pin 27 vertical ramp output and measure the voltage at line 22, line 142 and 262. Assign the respective measured values to Va, Vb and Vc. $V_{\text{lint16}} = (V_b - V_a) / (V_c - V_b)$ Vertical ramp output 	
	@0	Vlint0		Monitor the pin 27 vertical ramp output and measure the voltage at line 22, line 142 and 262 with VLIN_TOP = 00000. Assign the respective measured values to Va, Vb and Vc. $V_{\text{lint0}} = (V_b - V_a) / (V_c - V_b)$ Vertical ramp output 	VLIN_TOP: 00000
	@31	Vlint31		Monitor the pin 27 vertical ramp output and measure the voltage at line 22, line 142 and 262 with VLIN_TOP = 11111. Assign the respective measured values to Va, Vb and Vc. $V_{\text{lint31}} = (V_b - V_a) / (V_c - V_b)$ Vertical ramp output 	VLIN_TOP: 11111

Continued on next page.

LA76835NM

Continued from preceding page.

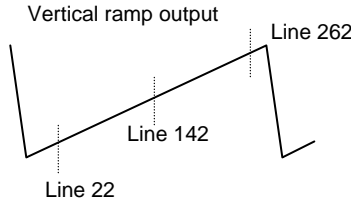
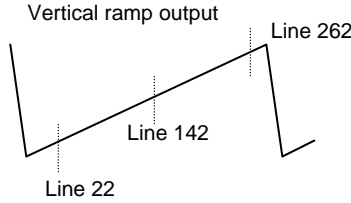
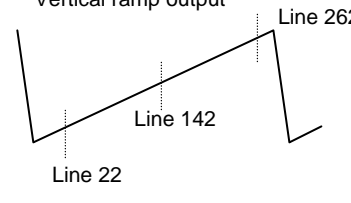
Input signal		Symbol	Test point	Input signal	Test method	Bus conditions
Vertical linearity BOTTOM	@16	Vlinb16	27	Y IN: Horizontal/ vertical sync signal	Monitor the pin 27 vertical ramp output and measure the voltage at line 22, line 142, and 262. Assign the respective measured values to Va, Vb, and Vc. $Vlinb16 = (Vb - Va) / (Vc - Vb)$ 	
	@0	Vlinb0			Monitor the pin 27 vertical ramp output and measure the voltage at line 22, line 142 and 262 with VLIN_BOTTOM = 00000. Assign the respective measured values to Va, Vb and Vc. $Vlinb0 = (Vb - Va) / (Vc - Vb)$ 	VLIN_BOTTOM: 00000
	@31	Vlinb31			Monitor the pin 27 vertical ramp output and measure the voltage at line 22, line 142 and 262 with VLIN_BOTTOM = 11111. Assign the respective measured values to Va, Vb and Vc. $Vlinb31 = (Vb - Va) / (Vc - Vb)$ 	VLIN_BOTTOM: 11111

Continued on next page.

LA76835NM

Continued from preceding page.

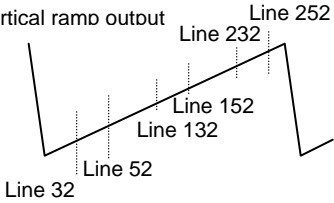
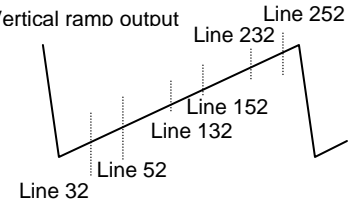
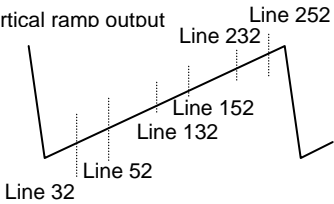
Input signal	Symbol	Test point	Input signal	Test method	Bus conditions	
Vertical S-shaped correction	@16	VScor16	27	Y IN: Horizontal/ vertical sync signal	Monitor the pin 27 vertical ramp output and measure the voltage at line 32, line 52, line 132, line 152, line 232 and 252. Assign the respective measured values to Va, Vb, Vc, Vd, Ve and Vf. $VScor16 = 0.5((Vb-Va)+(Vf-Ve)) / (Vd-Vc)$ 	VS:10000
	@0	VScor0		Monitor the pin 27 vertical ramp output and measure the voltage at the line 32, line 52, line 132, line 152, line 232 and line 252 with VSC = 000. Assign the respective measured values to Va, Vb, Vc, Vd, Ve and Vf. $VScor0 = 0.5((Vb-Va)+(Vf-Ve)) / (Vd-Vc)$ 		
	@31	VScor31		Monitor the pin 27 vertical ramp output and measure the voltage at the line 32, line 52, line 132, line 152, line 232 and line 252 with VSC = 000. Assign the respective measured values to Va, Vb, Vc, Vd, Ve and Vf. $VScor31 = 0.5((Vb-Va)+(Vf-Ve)) / (Vd-Vc)$ 	VSC: 11111	

Continued on next page.

LA76835NM

Continued from preceding page.

Input signal		Symbol	Test point	Input signal	Test method	Bus conditions	
Raster Cut	TOP	RASCUTT	27	Y IN: Horizontal/ vertical sync signal	Monitor the pin 27 vertical ramp output and measure the timing with which the changes in the lower part of the ramp output disappear.	RASTER_CUT: 1	
	BOTTOM	RASCUTB			Monitor the pin 27 vertical ramp output and measure the timing with which the changes in the upper part of the ramp output start.		
H Phase BOW	@8	HBOW8	31	Y IN: Horizontal/ vertical sync signal	Measure the delay times, at lines 22 and 142, from the rise of the pin 27 horizontal output pulse to the fall of the YIN horizontal sync signal. Let T1 and T2 be these measured values, respectively, and use them to calculate the following formula. $HBOW8 = T1 - T2$		
	@0	HBOW0	52		Measure the delay times, at lines 22 and 142, from the rise of the pin 27 horizontal output pulse to the fall of the YIN horizontal sync signal. Let T1 and T2 be these measured values, respectively, and use them to calculate the following formula. $HBOW0 = T1 - T2$		H_Phase_BOW: 0000
	@15	HBOW15			Measure the delay times, at lines 22 and 142, from the rise of the pin 27 horizontal output pulse to the fall of the YIN horizontal sync signal. Let T1 and T2 be these measured values, respectively, and use them to calculate the following formula. $HBOW15 = T1 - T2$		H_Phase_BOW: 1111

Continued on next page.

LA76835NM

Continued from preceding page.

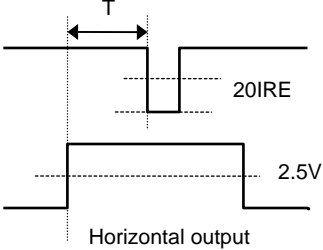
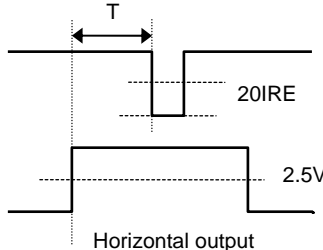
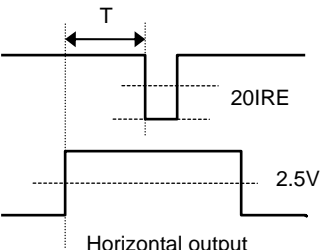
Input signal	Symbol	Test point	Input signal	Test method	Bus conditions
H Phase ANGLE	@8	HANG8	<div style="border: 1px solid black; width: 20px; height: 20px; margin: 5px; display: flex; align-items: center; justify-content: center;">31</div> <div style="border: 1px solid black; width: 20px; height: 20px; margin: 5px; display: flex; align-items: center; justify-content: center;">52</div>	<p>Y IN: Horizontal/ vertical sync signal</p> <p>Measure the delay times, at lines 22 and 142, from the rise of the pin 27 horizontal output pulse to the fall of the YIN horizontal sync signal. Let T1 and T2 be these measured values, respectively, and use them to calculate the following formula. HANG8 = T1-T2</p> 	
	@0	HANG0		<p>Measure the delay times, at lines 22 and 142, from the rise of the pin 27 horizontal output pulse to the fall of the YIN horizontal sync signal. Let T1 and T2 be these measured values, respectively, and use them to calculate the following formula. HANG0 = T1-T2</p> 	H_Phase_ANGLE: 0000
	@15	HANG15		<p>Measure the delay times, at lines 22 and 142, from the rise of the pin 27 horizontal output pulse to the fall of the YIN horizontal sync signal. Let T1 and T2 be these measured values, respectively, and use them to calculate the following formula. HANG15 = T1-T2</p> 	H_Phase_ANGLE: 1111

LA76835NM

HS/VS/VBLK

Input signal	Symbol	Test point	Input signal	Test method	Bus conditions
HS pulse output phase	PWHS	15	Y IN: Horizontal/ vertical sync signal	Monitor the HS output of pin 15 and measure the pulse width.	
VS pulse output phase	PWVS	16	Y IN: Horizontal/ vertical sync signal	Monitor the VS output of pin 16 and measure the pulse width.	
Vertical blanking period	@0	VBLK0	Y IN: Horizontal/ vertical sync signal	Monitor the B output of pin 20 and measure the vertical blanking period.	V_BLK_Select: 00
	@1	VBLK1		Monitor the B output of pin 20 and measure the vertical blanking period.	V_BLK_Select: 01
	@2	VBLK2		Monitor the B output of pin 20 and measure the vertical blanking period.	V_BLK_Select: 10
	@3	VBLK3		Monitor the B output of pin 20 and measure the vertical blanking period.	V_BLK_Select: 11

Horizontal Size Adjustment

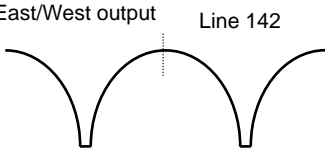
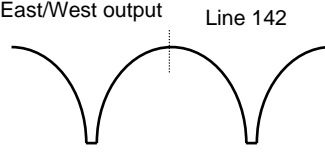
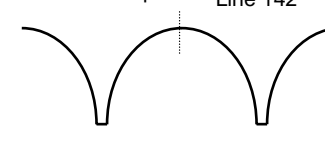
Input signal	Symbol	Test point	Input signal	Test method	Bus conditions
East/Wst DC voltage	@32	EWdc32	Y IN: Horizontal, vertical sync signal	Monitor the East/West output (parabolic wave output) of pin 26 and measure the voltage at line 142. <div style="text-align: center;">  </div>	
	@0	EWdc0		Monitor the East/West output (parabolic wave output) of pin 26 and measure the voltage at line 142. <div style="text-align: center;">  </div>	EWDC: 000000
	@63	EWdc63		Monitor the East/West output (parabolic wave output) of pin 26 and measure the voltage at line 142. <div style="text-align: center;">  </div>	EWDC: 111111

High-voltage Dependent Horizontal Size Compensation

Input signal	Symbol	Test point	Input signal	Test method	Bus conditions
Horizontal size compensation @0	Hsizecomp	26	Y IN: Horizontal, vertical sync signal	Monitor the West/East output of pin 26 and measure the voltage (Va) at line 142. Apply 4.0 V to pin 25 and measure again the voltage (Vb) at line 142. Hsizecomp = Va-Vb	HCOMP: 000

LA76835NM

Pincushion Distortion Compensation

Input signal		Symbol	Test point	Input signal	Test method	Bus conditions
East/West parabolic amplitude	@32	EWamp32	26	Y IN: Horizontal, vertical sync signal	Monitor the East/West output (parabolic wave output) of pin 26 and measure the voltage at line 22 (Va) and line 142 (Vb). $EWamp32 = Vb - Va$	
	@0	EWamp0			Monitor the East/West output (parabolic wave output) of pin 26 and measure the voltage at line 22 (Va) and line 142 (Vb). $EWamp0 = Vb - Va$	EWAMP000000
	@63	EWamp63			Monitor the East/West output (parabolic wave output) of pin 26 and measure the voltage at line 22 (Va) and line 142 (Vb). $EWamp63 = Vb - Va$	EWAMP111111

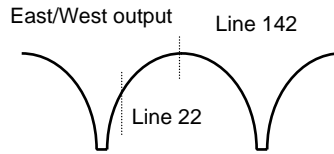
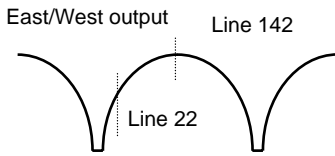
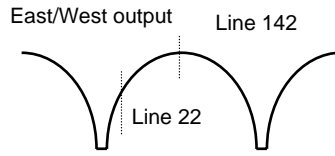

LA76835NM

Trapezoidal Distortion Compensation

Input signal		Symbol	Test point	Input signal	Test method	Bus conditions
East/West parabolic tilt	@32	EWtilt32	26	Y IN: Horizontal, vertical sync signal	Monitor the East/West output (parabolic wave output) of pin 26 and measure the voltage at line 22 (Va) and line 262 (Vb). EWtilt32 = Va-Vb <div style="text-align: center;"> </div>	
	@0	EWtilt0			Monitor the East/West output (parabolic wave output) of pin 26 and measure the voltage at line 22 (Va) and line 262 (Vb). EWtilt0 = Va-Vb <div style="text-align: center;"> </div>	EWTILT:000000
	@63	EWtilt63			Monitor the East/West output (parabolic wave output) of pin 26 and measure the voltage at line 22 (Va) and line 262 (Vb). EWtilt63 = Va-Vb <div style="text-align: center;"> </div>	EWTILT:111111

Corner Distortion Compensation

Input signal		Symbol	Test point	Input signal	Test method	Bus conditions
East/West parabolic corner	TOP	EWcortop	26	Y IN: Horizontal, vertical sync signal	Monitor the East/West output (parabolic wave output) of pin 26 and measure the voltage at line 22 under conditions of CORTOP: 1111 (Va) and CORTOP: 0000 (Vb). EWcortop = Va-Vb <div style="text-align: center;"> </div>	CORTOP: 1111-0000
	BOTTOM	EWcorbot			Monitor the East/West output (parabolic wave output) of pin 26 and measure the voltage at line 262 under conditions of CORBOT: 1111 (Va) and CORBOT: 0000 (Vb). EWcorbot = Va-Vb <div style="text-align: center;"> </div>	CORBOTTOM: 1111-0000

Continued on next page.

LA76835NM

Control Register Bit Allocation Map

Sub address	MSB		Data bits					LSB	
	DA0	DA1	DA2	DA3	DA4	DA5	DA6	DA7	
00000000	T_Disable	AFC gain&gate	H.FREQ						
	1	0	1	1	1	1	1	1	
00001	Vtrans	Audio.Mute	Video.Mute	H.PAHSE					
	0	0	0	1	0	0	0	0	
00010	Sync.Kill	V.SIZE							
	0	1	0	0	0	0	0	0	
00011	VSEPUP	V.KILL	V.POSI						
	0	0	1	0	0	0	0	0	
00100	V.TEST		COUNT.DWN.MOD	V.LIN TOP					
	0	0	0	1	0	0	0	0	
00101	V.COMP			V.LIN BOTTOM					
	1	1	1	1	0	0	0	0	
00110	*	*	*	V.SC					
	(0)	(0)	(0)	0	1	0	1	1	
00111	R.BIAS								
	0	0	0	0	0	0	0	0	
01000	G.BIAS								
	0	0	0	0	0	0	0	0	
01001	B.BIAS								
	0	0	0	0	0	0	0	0	
01010	*	R.DRIVE							
	(0)	1	0	0	0	0	0	0	
01011	Drive.Test	Half tone		Half tone Def	G.DRIVE				
	0	0	1	1	1	0	1	0	
01100	*	B.DRIVE							
	(0)	1	0	0	0	0	0	0	
01101	Blank.Def	Sub.Bright							
	0	1	0	0	0	0	0	0	
01110	*	Bright							
	(0)	1	0	0	0	0	0	0	
01111	*	Contrast							
	(0)	1	0	1	1	0	1	0	

Continued on next page.

* Operated on HV_{CC}

LA76835NM

Continued from preceding page.

Sub address	MSB			Data bits				LSB
	DA0	DA1	DA2	DA3	DA4	DA5	DA6	DA7
00010000	OSD Cnt.Test	*	*	ODS Contrast				
	0	(0)	(0)	1	0	0	0	0
10001	Coring Gain (W/Defeat)		Sharpness					
	0	0	0	0	0	0	0	0
10010	Tint.Test	Tint						
	0	1	0	0	0	0	0	0
10011	Color.Test	Color						
	0	1	0	0	0	0	0	0
10100	Video SW	*	*	*	*	Filter.Sys		
	0	(0)	(0)	(0)	(0)	0	0	0
10101	Gray Mode	Cross B/W		CbCr_IN	G-Y Angle	Color Killer ope,		
	0	0	0	0	(0)	0	0	0
10110	*	FBPBLK.SW	(Fsc Csync)	Y.APF	C.BPF Test		WPL Ope.Point (W/Defeat)	
	(0)	1	0	(0)	1	0	0	0
10111	Y Gamma Start		DC.Rest		Blk.Str.Shart (W/Defeat)		Blk.Str.Gain	
	0	0	0	0	1	1	0	0
11000	Auto.Flesh	C.Ext	C.Bypass	C_Kill ON	C_Kill OFF	*	*	*
	0	0	1	0	0	(0)	(0)	(0)
11001	Cont.Test	Digital OSD	Brt.Abl.Def	Mid.Stp.Def	.	Bright.Abl.Threshold		
	0	0	0	0	(0)	1	0	0
11010	*	*	*	*	R-Y/B-Y Angle			
	(0)	(0)	(0)	(0)	1	0	0	0
11011	Cb DC Offset				Cr DC Offset			
	1	0	0	0	1	0	0	0
11100	Audio SW	Volume						
	0	0	0	0	0	0	0	0
11101	*	VOL.FIL	RF.AGC					
	(0)	0	1	0	0	0	0	0
11110	FM.Mute	*	*	VIF.Sys.SW	*	*	*	IF.AGC
	0	(0)	(0)	(0)	(0)	(0)	(0)	0
11111	VIDEO.LEVEL			*	*	*	*	*
	1	0	0	(0)	(0)	(0)	(0)	(0)

Continued on next page.

LA76835NM

Continued from preceding page.

Sub address	MSB		Data bits					LSB	
	DA0	DA1	DA2	DA3	DA4	DA5	DA6	DA7	
00100000	*	*	East/West DC						
	(0)	(0)	1	0	0	0	0	0	
100001	*	*	East/West Amp						
	(0)	(0)	1	0	0	0	0	0	
100010	*	Tint. Through	East/West Tilt						
	(0)	0	1	0	0	0	0	0	
100011	East/West Corner Bottom			East/West Corner TOP					
	0	0	0	0	0	0	0	0	
100100	EW_Cor.SW	*	East/West Test			H.Size.Comp			
	0	(0)	0	0	0	1	1	1	
100101	H Phase Bow Correction			H Phase Angle Correction					
	1	0	0	0	1	0	0	0	
100110	Pre-Shoot Adjustment		Over-Shoot Adjustment		Chroma Trap Fil Test			*	
	0	0	0	0	1	0	0	(0)	
100111	H BLK K			H BLK R					
	1	0	0	0	1	0	0	0	
101000	Sync Sep Sens.			VM GAIN			YCMIX_SW	*	
	1	0	0	1	0	0	0	(0)	
101001	VSIZE75	Raster cut	V BLK Select		*	*	*	*	
	0	0	0	0	(0)	(0)	(0)	(0)	
101010	*	*	*	*	Y TH		Y GAIN		
	(0)	(0)	(0)	(0)	0	0	0	0	
101011	R Width		R Offset		B Width		B Offset		
	0	0	0	0	0	0	0	0	

BUS Control Register Bit Allocation Map

	MSB		Data bits					LSB	
	DA0	DA1	DA2	DA3	DA4	DA5	DA6	DA7	
2nd Byte	X.Ray	*	H.Lock	RF.AGC	KILLER	V.TRI	*	ST/NONST	
	*	(0)	*	*	*	*	(0)	*	

LA76835NM

Initial Conditions

Register	
T.Disable	1HEX
AFC.gain&gate	0HEX
H.FREQ	3FHEX
Vtrans	0HEX
Audio.Mute	0HEX
Video.Mute	0HEX
H.PHASE	10HEX
Sync.kill	0HEX
V.SIZE	40HEX
V.SEPUP	0HEX
V.KILL	0HEX
V.POSI	20HEX
V.TEST	0HEX
CD.MODE	0HEX
V.LIN.TOP	10HEX
V.COMP	7HEX
V.LIN.BOTTOM	10HEX
V.SC	BHEX
R.BIAS	0HEX
G.BIAS	0HEX
B.BIAS	0HEX
R.DRIVE	40HEX
G.DRIVE	AHEX
B.DRIVE	40HEX
Drive.Test	0HEX
Half.tone	1HEX
Half.tone.Def	1HEX
Blank.Def	0HEX
Sub.Bias	40HEX
Bright	40HEX
Contrast	40HEX
OSD.Contrast	10HEX
OSD.Cnt.Test	0HEX
Coring.Gain	0HEX
Sharpness	0HEX
Tint	40HEX
Tint.Test	0HEX
Color	40HEX
Color.Test	0HEX
Video.SW	0HEX
Filter.SYS	0HEX
Gray.Mode	0HEX
Cross.B/W	0HEX
CbCr.IN	0HEX
G-Y.Angle.SW	0HEX
Color.kill.ope	0HEX
FBPBLK.SW	1HEX
(fsc.or.Csync)	0HEX
Y.APF	0HEX
C.BPF.TEST	2HEX
WPL.Ope.Point	0HEX
Y.Gamma.Start	0HEX
DC.Rest	0HEX

Register	
Blk.Str.Start	3HEX
Blk.Str.Gain	0HEX
Auto.Flesh	0HEX
C.Ext	0HEX
C.Bypass	1HEX
C.Kill.ON	0HEX
C.Kill.OFF	0HEX
Cont.Test	0HEX
Digital.OSD	0HEX
Brт.Abl.Def	0HEX
Mid.Stp.def	0HEX
Bright.Abl.Threshold	4HEX
R-Y/B-y.Angle	8HEX
Cb.DC.Offset	8HEX
Cr.DC.Offset	8HEX
Audio.SW	0HEX
Volume	0HEX
S.TRAP.SW	0HEX
VOL.FIL	0HEX
RF.AGC	20HEX
FM.Mute	0HEX
VIF.Sys.SW	0HEX
IF.AGC	0HEX
VIDEO.LEVEL	4HEX
East/West.DC	20HEX
East/West.Amp	20HEX
East/West.Tilt	20HEX
Tint.Through	0HEX
East/West.Corner.Bottom	0HEX
East/West.Corner.TOP	0HEX
East/West.Corner.SW	0HEX
Hlock.Vdet	0HEX
East/West.Test	0HEX
H.Size.Comp	7HEX
H.Phase.Bow.Correction	8HEX
H.Phase.Angle.Correction	8HEX
Pre-Shoot.Adjustment	0HEX
Over-Shoot.Adjustment	0HEX
Chroma.Trap.Fil.Test	4HEX
H.BLK.L	8HEX
H.BLK.R	8HEX
Sync.Sep.Sence	4HEX
VM.Gain	4HEX
YCMIX.SW	0HEX
V.SIZE0.75	0HEX
Raster.cut	0HEX
V.BLK.Select	0HEX
Y.TH	0HEX
Y.GAain	0HEX
R.Width	0HEX
R.Offset	0HEX
B.Width	0HEX
B.Offset	0HEX

LA76835NM

Pin Assignment

Pin	Function	Pin	Function
1	F.GND	80	IF GND
2	F.GND	79	PIF Input1
3	F.GND	78	PIF Input2
4	F.GND	77	RF AGC Output
5	IF V _{CC}	76	PIF AGC
6	FM Filter	75	FM Output
7	AFT Output	74	FM&VOL V _{CC}
8	Bus Data	73	AUDIO Output
9	Bus Clock	72	NC
10	ABL	71	FM Noise Filter
11	Red Input	70	NC
12	Green Input	69	SIF Input
13	Blue Input	68	SIF APC Filter
14	Fast Blanking Input	67	SIF Output
15	HS	66	Ext. Audio Input
16	VS	65	APC Filter
17	RGB V _{CC}	64	F.GND
18	Red Output	63	F.GND
19	Green Output	62	F.GND
20	Blue Output	61	F.GND
21	F.GND	60	VCO Coil 1
22	F.GND	59	VCO Coil 2
23	F.GND	58	FLL Filter
24	F.GND	57	NC
25	V Size Comp input	56	Video Output
26	E/W Output	55	DC Rest & Black Level Detector
27	Vertical Output	54	Internal Video Input (S-C IN)
28	Ramp ALC Filter	53	Video/Vertical V _{CC}
29	Horizontal/BUS V _{CC}	52	External Video Input (Y IN)
30	Horizontal AFC Filter	51	NC
31	Horizontal Output	50	Selecterd Video Output
32	CPU V _{CC}	49	Video/Chroma/Vertical GND
33	Flyback pulse Input	48	VM Input
34	H VCO I ref	47	Clamp Filter
35	CPU Reset	46	3.58MHz Crystal
36	H.GND	45	Chroma APC Filter
37	VM Output	44	fsc (3.58MHz) Output
38	X-RAY	43	F.GND
39	Cb Input	42	F.GND
40	Cr Input	41	F.GND

- Specifications of any and all SANYO Semiconductor products described or contained herein stipulate the performance, characteristics, and functions of the described products in the independent state, and are not guarantees of the performance, characteristics, and functions of the described products as mounted in the customer's products or equipment. To verify symptoms and states that cannot be evaluated in an independent device, the customer should always evaluate and test devices mounted in the customer's products or equipment.
- SANYO Semiconductor Co., Ltd. strives to supply high-quality high-reliability products. However, any and all semiconductor products fail with some probability. It is possible that these probabilistic failures could give rise to accidents or events that could endanger human lives, that could give rise to smoke or fire, or that could cause damage to other property. When designing equipment, adopt safety measures so that these kinds of accidents or events cannot occur. Such measures include but are not limited to protective circuits and error prevention circuits for safe design, redundant design, and structural design.
- In the event that any or all SANYO Semiconductor products (including technical data, services) described or contained herein are controlled under any of applicable local export control laws and regulations, such products must not be exported without obtaining the export license from the authorities concerned in accordance with the above law.
- No part of this publication may be reproduced or transmitted in any form or by any means, electronic or mechanical, including photocopying and recording, or any information storage or retrieval system, or otherwise, without the prior written permission of SANYO Semiconductor Co., Ltd.
- Any and all information described or contained herein are subject to change without notice due to product/technology improvement, etc. When designing equipment, refer to the "Delivery Specification" for the SANYO Semiconductor product that you intend to use.
- Information (including circuit diagrams and circuit parameters) herein is for example only; it is not guaranteed for volume production. SANYO Semiconductor believes information herein is accurate and reliable, but no guarantees are made or implied regarding its use or any infringements of intellectual property rights or other rights of third parties.

This catalog provides information as of December, 2006. Specifications and information herein are subject to change without notice.