



TWO HOLE HYLUG™ CODE CONDUCTOR LONG BARREL

TYPES YA-2N, YA-2TC,
YA-4N

UL LISTED 90°C,
600 VOLT TO 35 KV ♦

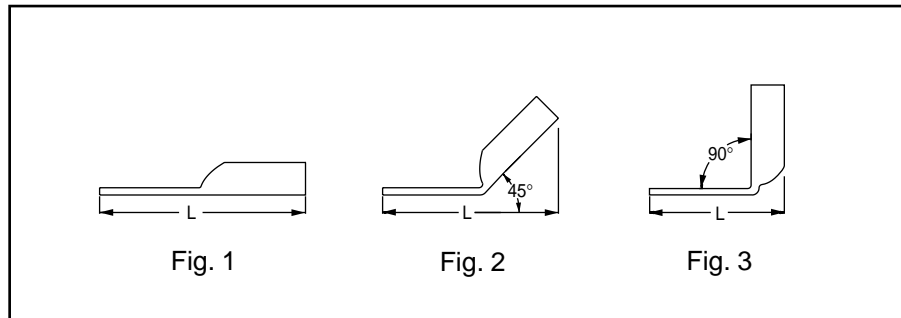
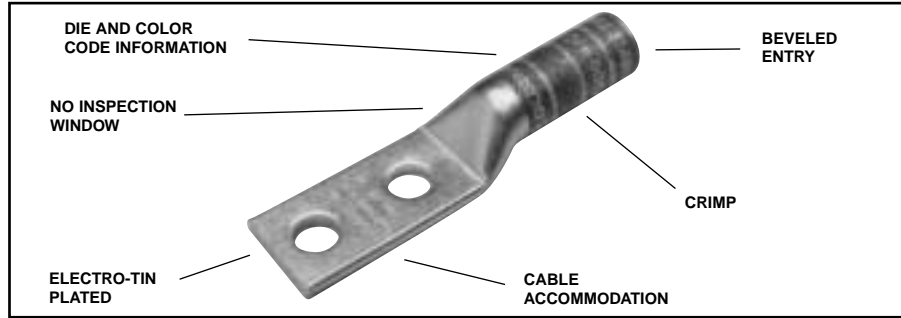
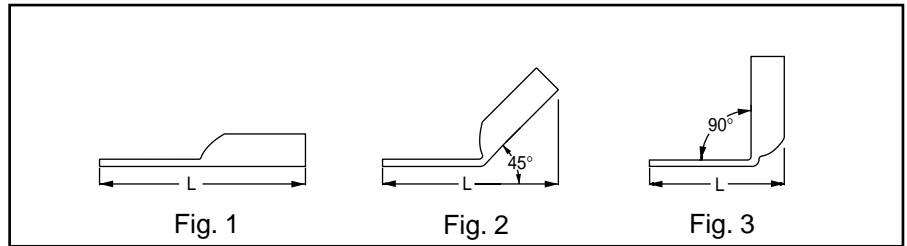

Fig Catalog Number	#	Conductor		Stud Hole Size	Stud Hole Spacing	L	Tongue Width	Tongue Angle	Installation Tooling						WIRE STRIP LENGTH		
		AWG	*** MM ²						Mechanical			Hydraulic		COLOR CODE		DIE INDEX	
									Y1MRTC Y2MR	MD7-34R	BCT500 Y500CT	Y750-2/Y46C* BAT-750C					
YA8C2TC14	1	#8 STR.	10	1/4"	5/8"	2.33"	.40"	Straight	Y2MR (2) Y1MRTC (2)	W8CVT (2) W8CRT (2) X8CRT (2)	W8CVT (2) W8CRT (2) X8CRT (2)	U8CRT (1)	Red	49	1"		
YA8C2TC14-45	2					2.20"	.40"	45 Degree									
YA8C2TC14-90	3					1.49"	.41"	90 Degree									
YA8C2TC14E2	1					2.45"	.41"	Straight									
YA8C2TC14E2-45	2					2.33"	.41"	45 Degree									
YA8C2TC14E2-90	3					1.62"	.41"	90 Degree									
YA8C2TC38	1					37/24	16	3/8"								1"	2.89"
YA8C2TC38-45	2	2.72"	.73"	45 Degree													
YA8C2TC38-90	3	2.05"	.73"	90 Degree													
YA6C2N	1	#6 AWG	16	1/2"	1-3/4"	4.40"	.81"	Straight	Y2MR (2) Y1MRTC (2)	W5CVT (2) W5CRT (2) X5CRT (2) X8CART (2)	W5CVT (2) W5CRT (2) X5CRT (2) X8CART (2)	U5CRT (2) U8CABT (2)	Blue	7	1-3/16"		
YA6C2N-45	2					4.29"	.81"	45 Degree									
YA6C2N-90	3					3.28"	.81"	90 Degree									
YA6C2TC14	1			1/4"	5/8"	1/4"	5/8"	2.65"								.45"	Straight
YA6C2TC14-45	2							2.45"								.45"	45 Degree
YA6C2TC14-90	3							1.51"								.45"	90 Degree
YA6C2TC14E1	1			1/4"	1"	1/4"	1"	3.03"								.45"	Straight
YA6C2TC14E1-45	2							2.83"								.45"	45 Degree
YA6C2TC14E1-90	3							1.88"								.45"	90 Degree
YA6C2TC14E2	1			1/4"	3/4"	1/4"	3/4"	2.78"								.45"	Straight
YA6C2TC14E2-45	2							2.58"								.45"	45 Degree
YA6C2TC14E2-90	3							1.63"								.45"	90 Degree
YA6C2TC38	1			3/8"	1"	3/8"	1"	3.22"								.63"	Straight
YA6C2TC38-45	2							2.97"								.63"	45 Degree
YA6C2TC38-90	3							2.06"								.63"	90 Degree
YA6C2TC38E2	1			3/8"	3/4"	3/8"	3/4"	2.97"								.63"	Straight
YA6C2TC38E2-45	2							2.72"								.63"	45 Degree
YA6C2TC38E2-90	3							1.81"								.63"	90 Degree
YA6C2TC38E6	1			3/8"	7/8"	3/8"	7/8"	2.99"								.63"	Straight
YA6C2TC38E6-45	2							2.75"								.63"	45 Degree
YA6C2TC38E6-90	3							1.83"								.63"	90 Degree

* Use P-UADP-1 adaptor with "U" -dies in Y46 HYPRESS™.
 ** P-RT die sets for use in Y46 HYPRESS™ only, P-UADP-1 adaptor not required.
 *** The MM² conductor sizes listed are the recommendations for Class 2 conductor.
 † Available undrilled. Add suffix "U" to catalog number. (Example: YA25U).
 ‡ See tooling section of this catalog for complete tool and die listings.
 ♦ For applications greater than 2000 Volts consult cable manufacturer for voltage stress relief instructions.



TWO HOLE HYLUG™ CODE CONDUCTOR LONG BARREL (CONTINUED)



Catalog Number	Fig #	Conductor		Stud Hole Size	Stud Hole Spacing	L	Tongue Width	Tongue Angle	Installation Tooling				WIRE STRIP LENGTH											
		AWG	*** MM ²						Mechanical		Hydraulic			COLOR CODE	DIE INDEX									
									Y1MRTC Y2MR	MD7-34R	BCT500 Y500CT	Y750-2/Y46C* BAT-750C												
YA5C2N	1	5 AWG	-	1/2"	1-3/4"	4.43"	.83"	Straight	Y2MR (2) Y1MRTC (2)	W5CRT (2) W5CVT (2) X5CRT (2)	X5CRT (2) X5CVT (2) W5CRT (2)	U5CRT (2)	Blue	7	1-3/16"									
YA5C2N-45	2					4.31"	.83"	45 Degree																
YA5C2N-90	3					3.28"	.83"	90 Degree																
YA4C2N	1	4 AWG	-	1/2"	1-3/4"	4.45"	.81"	Straight	Y2MR (4) Y1MRTC (4)	W4CVT (2) W4CRT (2) X4CRT (2)	W4CVT (2) W4CRT (2) X4CRT (2)	U4CRT (2) U6CABT (2)	Gray	8	1-3/16"									
YA4C2N-45	2					4.32"	.81"	45 Degree																
YA4C2N-90	3					3.30"	.81"	90 Degree																
YA4C2TC14	1			1/4"	5/8"	3/4"	2.70"	.50"								Straight								
YA4C2TC14-45	2						2.51"	.50"								45 Degree								
YA4C2TC14-90	3						1.54"	.50"								90 Degree								
YA4C2TC14E2	1			1/4"	3/4"	3/4"	2.83"	.50"								Straight								
YA4C2TC14E2-45	2						2.64"	.50"								45 Degree								
YA4C2TC14E2-90	3						1.66"	.50"								90 Degree								
YA4C2TC38	1			3/8"	1"	1"	3.26"	.56"								Straight								
YA4C2TC38-45	2						3.03"	.56"								45 Degree								
YA4C2TC38-90	3						2.09"	.56"								90 Degree								
YA3C2N	1	#3 STR #3 AWG #2 SOL	25	1/2"	1-3/4"	4.62"	.81"	Straight	Y1MRTC (4)	W3CRT (2)	W3CRT (2)	U3CRT (2)	White	9	1-5/16"									
YA3C2N-45	2					4.44"	.81"	45 Degree																
YA3C2N-90	3					3.32"	.81"	90 Degree																
YA3C2TC14	1			1/4"	5/8"	3/4"	2.87"	.55"								Straight								
YA3C2TC14-45	2						2.62"	.55"								45 Degree								
YA3C2TC14-90	3						1.55"	.55"								90 Degree								
YA3C2TC14E2	1			1/4"	3/4"	3/4"	2.99"	.55"								Straight								
YA3C2TC14E2-45	2						2.75"	.55"								45 Degree								
YA3C2TC14E2-90	3						1.68"	.55"								90 Degree								
YA3C2TC38	1			3/8"	1"	1"	3.43"	.58"								Straight								
YA3C2TC38-45	2						3.16"	.58"								45 Degree								
YA3C2TC38-90	3						2.11"	.58"								90 Degree								
YA3C2TC38E2	1			3/8"	3/4"	3/4"	3.18"	.58"								Straight								
YA3C2TC38E2-45	2						2.91"	.58"								45 Degree								
YA3C2TC38E2-90	3						1.86"	.58"								90 Degree								
YA2C2N	1			#2 AWG	35	1/2"	1-3/4"	4.64"								.81"	Straight	Y2MR (4) Y1MRTC (4)	W2CVT (2) W2CRT (2) X2CRT (2)	W2CVT (2) W2CRT (2) X2CRT (2)	U2CRT (2)	Brown	10	1-5/16"
YA2C2N-45	2							4.46"								.81"	45 Degree							
YA2C2N-90	3							3.34"								.81"	90 Degree							
YA2C2TC14	1	1/4"	5/8"			3/4"	2.86"	.60"	Straight															
YA2C2TC14-45	2						2.66"	.60"	45 Degree															
YA2C2TC14-90	3						1.58"	.60"	90 Degree															
YA2C2TC14E2	1	1/4"	3/4"			3/4"	2.98"	.60"	Straight															
YA2C2TC14E2-45	2						2.78"	.60"	45 Degree															
YA2C2TC14E2-90	3						1.71"	.60"	90 Degree															
YA2C2TC38E2	1	3/8"	3/4"			3/4"	3.17"	.60"	Straight															
YA2C2TC38E2-45	2						2.97"	.60"	45 Degree															
YA2C2TC38E2-90	3						1.90"	.60"	90 Degree															
YA2C2TC516E2	1	5/16"	3/4"			3/4"	3.05"	.60"	Straight															
YA2C2TC516E2-45	2						2.84"	.60"	45 Degree															
YA2C2TC516E2-90	3						1.77"	.60"	90 Degree															
YA2C2NTC38	1	3/8"	1-3/4"			1-3/4"	4.17"	.60"	Straight															
YA2C2NTC38-45	2						3.97"	.60"	45 Degree															
YA2C2NTC38-90	3						2.90"	.60"	90 Degree															

* Use P-UADP-1 adaptor with "U" -dies in Y46 HYPRESS™.
 ** P-RT die sets for use in Y46 HYPRESS™ only, P-UADP-1 adaptor not required.
 *** The MM² conductor sizes listed are the recommendations for Class 2 conductor.

" Available undrilled. Add suffix "U" to catalog number. (Example: YA25U).
 ▲ See tooling section of this catalog for complete tool and die listings.

◆ For applications greater than 2000 Volts consult cable manufacturer for voltage stress relief instructions.



TWO HOLE HYLUG™ CODE CONDUCTOR LONG BARREL (CONTINUED)

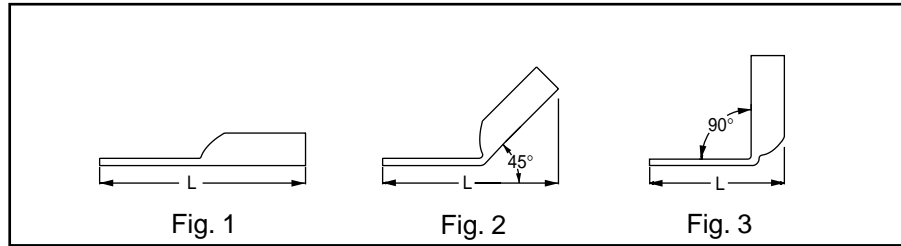

Catalog Number	Fig #	Conductor		Stud Hole Size	Stud Hole Spacing	L	Tongue Width	Tongue Angle	Installation Tooling				WIRE STRIP LENGTH											
		AWG	MM ²						Mechanical		Hydraulic			COLOR CODE	DIE INDEX									
									Y1MRTC Y2MR	MD7-34R	BCT500 Y500CT	Y750-2/Y46C* BAT-750C												
YA2C2TC38	1	#2 AWG	35	3/8"	1"	3.42"	.60"	Straight	Y2MR (4) Y1MRTC (4)	W2CVT (2) W2CRT (2) X2CRT (2)	W2CVT (2) W2CRT (2) X2CRT (2)	U2CRT (2)	Brown	10	1-5/16"									
YA2C2TC38-45	2					3.22"	.60"	45 Degree																
YA2C2TC38-90	3					2.14"	.60"	90 Degree																
YA2C2TC38E6	1			3/8"	7/8"	3.30"	.60"	Straight																
YA2C2TC38E6-45	2					3.10"	.60"	45 Degree																
YA2C2TC38E6-90	3					2.02"	.60"	90 Degree																
YA2C2TC516E2	1			5/16"	3/4"	3.05"	.60"	Straight																
YA2C2TC516E2-45	2					2.84"	.60"	45 Degree																
YA2C2TC516E2-90	3					1.77"	.60"	90 Degree																
YA1C2N	1	1 AWG	50	1/2"	1-3/4"	4.82"	.81"	Straight	Y1MRTC (4)	W1CVT (2) W1CRT-1 (2) X1CRT-1 (2)	W1CVT (2) W1CRT-1 (2) X1CRT-1 (2)	U1CRT-1 (2) U4CABT (2)	Green	11	1-1/2"									
YA1C2N-45	2					4.58"	.81"	45 Degree																
YA1C2N-90	3					3.36"	.81"	90 Degree																
YA1C2TC14	1			1/4"	5/8"	3.03"	.68"	Straight																
YA1C2TC14-45	2					2.76"	.68"	45 Degree																
YA1C2TC14-90	3					1.60"	.68"	90 Degree																
YA1C2TC14E2	1			1/4"	3/4"	3.15"	.75"	Straight																
YA1C2TC14E2-45	2					2.88"	.75"	45 Degree																
YA1C2TC14E2-90	3					1.73"	.75"	90 Degree																
YA1C2TC38	1			3/8"	1"	3.59"	.68"	Straight																
YA1C2TC38-45	2					3.32"	.68"	45 Degree																
YA1C2TC38-90	3					2.16"	.68"	90 Degree																
YA252N	1			1/0 AWG	-	1/2"	1-3/4"	4.81"								.81"	Straight	-	W25VT (4) W25RT (4) X25RT (4)	W25VT (4) W25RT (4) X25RT (4)	U25RT (2) U2CABT (2)	Pink	12	1-7/16"
YA252N-45	2							4.56"								.81"	45 Degree							
YA252N-90	3							3.38"								.81"	90 Degree							
YA252TC14	1	1/4"	5/8"			3.05"	.75"	Straight																
YA252TC14-45	2					2.82"	.75"	45 Degree																
YA252TC14-90	3					1.64"	.75"	90 Degree																
YA252TC14E2	1	1/4"	3/4"			3.18"	.75"	Straight																
YA252TC14E2-45	2					2.94"	.75"	45 Degree																
YA252TC14E2-90	3					1.76"	.75"	90 Degree																
YA252TC38	1	3/8"	1"			3.62"	.75"	Straight																
YA252TC38-45	2					3.38"	.75"	45 Degree																
YA252TC38-90	3					2.20"	.75"	90 Degree																
YA252TC516	1	5/16"	1"			3.49"	.75"	Straight																
YA252TC516-45	2					3.26"	.75"	45 Degree																
YA252TC516-90	3					2.08"	.75"	90 Degree																
YA252NTC38	1	3/8"	1-3/4"			4.37"	.75"	Straight																
YA252NTC38-45	2					4.13"	.75"	45 Degree																
YA252NTC38-90	3					2.95"	.75"	90 Degree																
YA262N	1	2/0 AWG	70			1/2"	1-3/4"	4.97"	.83"	Straight	-	W26VT (4) W26RT (4) X26RT (4)	W26VT (4) W26RT (4) X26RT (4)	U26RT (2)	Black	13	1-9/16"							
YA262N-45	2							4.69"	.83"	45 Degree														
YA262N-90	3							3.41"	.83"	90 Degree														
YA262TC14	1			1/4"	5/8"	3.22"	.83"	Straight																
YA262TC14-45	2					2.94"	.83"	45 Degree																
YA262TC14-90	3					1.66"	.83"	90 Degree																
YA262TC14E2	1			1/4"	3/4"	3.34"	.83"	Straight																
YA262TC14E2-45	2					3.06"	.83"	45 Degree																
YA262TC14E2-90	3					1.79"	.83"	90 Degree																

* Use P-UADP-1 adaptor with "U" -dies in Y46 HYPRESS™.
 ** P-RT die sets for use in Y46 HYPRESS™ only, P-UADP-1 adaptor not required.
 *** The MM² conductor sizes listed are the recommendations for Class 2 conductor.

" Available undrilled. Add suffix "U" to catalog number. (Example: YA25U).
 ▲ See tooling section of this catalog for complete tool and die listings.

◆ For applications greater than 2000 Volts consult cable manufacturer for voltage stress relief instructions.



TWO HOLE HYLUG™ CODE CONDUCTOR LONG BARREL (CONTINUED)

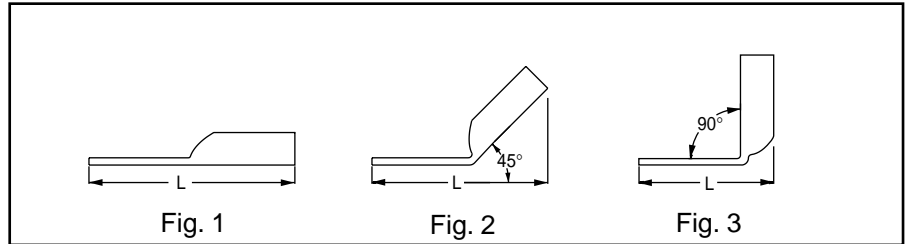

Catalog Number	Fig #	Conductor				Installation Tooling									WIRE STRIP LENGTH									
		AWG	*** MM ²	Stud Hole Size	Stud Hole Spacing	L	Tongue Width	Tongue Angle	Mechanical			Hydraulic		COLOR CODE		DIE INDEX								
									Y1MRTC Y2MR	MD7-34R	BCT500 Y500CT	Y750-2/Y46C* BAT-750C												
YA262TC38	1	2/0 AWG	70	3/8"	1"	3.78"	.83"	Straight	-	W26VT (4) W26RT (4) X26RT (4)	W26VT (4) W26RT (4) X26RT (4)	U26RT (2)	Black	13	1-9/16"									
YA262TC38-45	2					3.50"	.83"	45 Degree																
YA262TC38-90	3					2.22"	.83"	90 Degree																
YA272N	1	3/0 AWG	95	1/2"	1-3/4"	5.01"	.91"	Straight	-	W27VT (4) W27RT (4) X27RT (6)	W27VT (4) W27RT (4) X27RT (6)	U27RT (2)	Orange	14	1-9/16"									
YA272N-45	2					4.73"	.91"	45 Degree																
YA272N-90	3					3.44"	.91"	90 Degree																
YA272TC14E2	1			3.38"	.91"	Straight																		
YA272TC14E2-45	2			3.10"	.91"	45 Degree																		
YA272TC14E2-90	3			1.82"	.91"	90 Degree																		
YA272TC38	1			3.82"	.90"	Straight																		
YA272TC38-45	2			3.54"	.90"	45 Degree																		
YA272TC38-90	3			2.25"	.90"	90 Degree																		
YA282N	1	4/0 AWG	-	1/2"	1-3/4"	5.17"	1.02"	Straight	-	W28VT (4) W28RT (4) X28RT (6)	W28VT (4) W28RT (4) X28RT (6)	U28RT (2)	Purple	15	1-11/16"									
YA282N-45	2					4.88"	1.02"	45 Degree																
YA282N-90	3					3.49"	1.02"	90 Degree																
YA282TC38	1			3.99"	1.02"	Straight																		
YA282TC38-45	2			3.69"	1.02"	45 Degree																		
YA282TC38-90	3			2.30"	1.02"	90 Degree																		
YA282TC14E2	1			3.55"	1.02"	Straight																		
YA282TC14E2-45	2			3.25"	1.02"	45 Degree																		
YA282TC14E2-90	3			1.86"	1.02"	90 Degree																		
YA282NTC38	1			4.74"	1.02"	Straight																		
YA282NTC38-45	2			4.44"	1.02"	45 Degree																		
YA282NTC38-90	3			3.05"	1.02"	90 Degree																		
YA292N	1			250 kcmil	120	1/2"	1-3/4"	5.21"								1.11"	Straight	-	W29VT (4) X29RT (8)	W29VT (4) W29RT (4) X29RT (8)	U29RT (2)	Yellow	16	1-11/16"
YA292N-45	2							4.94"								1.11"	45 Degree							
YA292N-90	3							3.52"								1.11"	90 Degree							
YA292TC38	1	4.02"	1.10"			Straight																		
YA292TC38-45	2	3.75"	1.10"			45 Degree																		
YA292TC38-90	3	2.34"	1.10"			90 Degree																		
YA302TC38	1	300 kcmil	150	3/8"	1"	4.45"	1.20"	Straight	-	W30VT (4)	W30VT (4) W30RT (4)	U30RT (4) U28ART (4)	White	17	2"									
YA302TC38-45	2					4.07"	1.20"	45 Degree																
YA302TC38-90	3					2.37"	1.20"	90 Degree																
YA302N	1			5.64"	1.20"	Straight																		
YA302N-45	2			5.26"	1.20"	45 Degree																		
YA302N-90	3			3.56"	1.20"	90 Degree																		
YA312N	1			350 kcmil	185	1/2"	1-3/4"	5.68"								1.29"	Straight	-	W31VT (4)	W31VT (4) W31RT (4)	U31RT (4) U29ART (4)	Red	18	2-1/16"
YA312N-45	2							5.31"								1.29"	45 Degree							
YA312N-90	3							3.60"								1.29"	90 Degree							
YA312TC14E2	1	4.05"	1.29"			Straight																		
YA312TC14E2-45	2	3.68"	1.29"			45 Degree																		
YA312TC14E2-90	3	1.97"	1.29"			90 Degree																		
YA312TC38	1	4.49"	1.29"			Straight																		
YA312TC38-45	2	4.12"	1.29"			45 Degree																		
YA312TC38-90	3	2.41"	1.29"			90 Degree																		
YA322N	1	400 kcmil	-	1/2"	1-3/4"	5.85"	1.38"	Straight	-	W32VT (4)	W32VT (4) W32RT (4)	U32RT (4) U30ART (4)	Blue	19	2-3/16"									
YA322N-45	2					5.47"	1.38"	45 Degree																
YA322N-90	3					3.64"	1.38"	90 Degree																

* Use P-UADP-1 adaptor with "U" dies in Y46 HYPRESS™.
 ** P-RT die sets for use in Y46 HYPRESS™ only, P-UADP-1 adaptor not required.
 *** The MM² conductor sizes listed are the recommendations for Class 2 conductor.

* Available undrilled. Add suffix "U" to catalog number. (Example: YA25U).
 ▲ See tooling section of this catalog for complete tool and die listings.

◆ For applications greater than 2000 Volts consult cable manufacturer for voltage stress relief instructions.



TWO HOLE HYLUG™ CODE CONDUCTOR LONG BARREL (CONTINUED)

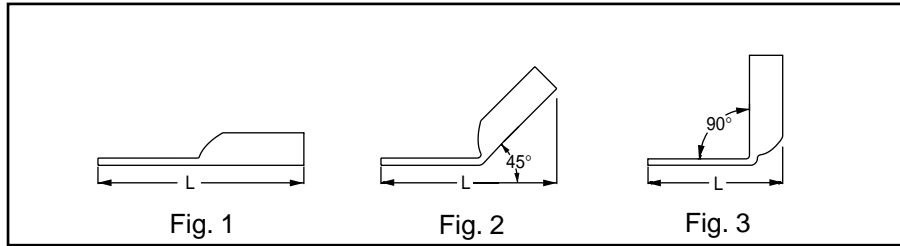

Catalog Number	Fig #	Conductor		Stud Hole Size	Stud Hole Spacing	L	Tongue Width	Tongue Angle	Installation Tooling						WIRE STRIP LENGTH		
		AWG	*** MM²						Mechanical		Hydraulic		COLOR CODE	DIE INDEX			
									Y1MRTC Y2MR	MD7-34R	BCT500 Y500CT	Y750-2/Y46C* BAT-750C					
YA322TC38	1	450 kcmil	-	3/8"	1"	4.66"	1.38"	Straight	-	W32VT (4)	W32VT (4) W32RT (4)	U32RT (4) U30RT (4)	Blue	19	2-3/16"		
YA322TC38-45	2					4.28"	1.38"	45 Degree									
YA322TC38-90	3					2.46"	1.38"	90 Degree									
YA332N	1	450 kcmil	-	1/2"	1-3/4"	5.93"	1.48"	Straight	-	W33VT (4)	W33VT (4) W33RT (4)	U33RT	Gray	326	2-5/16"		
YA332N-45	2					5.57"	1.48"	45 Degree									
YA332N-90	3					3.70"	1.48"	90 Degree									
YA342N	1	500 kcmil	240	1/2"	1-3/4"	6.06"	1.52"	Straight	-	W34VT (4)	W34VT (4) W34RT (4)	U34RT (4) U31ART (4)	Brown	20	2-1/2"		
YA342N-45	2					5.72"	1.52"	45 Degree									
YA342N-90	3					3.73"	1.52"	90 Degree									
YA342TC14E2	1			500 kcmil	240	1/4"	3/4"	4.46"								1.55"	Straight
YA342TC14E2-45	2							4.09"								1.55"	45 Degree
YA342TC14E2-90	3					2.10"	1.55"	90 Degree									
YA342TC38	1					3/8"	1"	4.90"								1.55"	Straight
YA342TC38-45	2							4.53"								1.55"	45 Degree
YA342TC38-90	3			2.54"	1.55"			90 Degree									
YA352N	1	550 kcmil	-	1/2"	1-3/4"	6.49"	1.65"	Straight	-	-	-	U35RT (4)	Yellow	21	2-11/16"		
YA352N-45	2					6.06"	1.65"	45 Degree									
YA352N-90	3					3.77"	1.65"	90 Degree									
YA362N	1	600 kcmil	300	1/2"	1-3/4"	6.59"	1.69"	Straight	-	-	-	U36RT (4) U32ART (4)	Green	22	2-3/4"		
YA362N-45	2					6.17"	1.69"	45 Degree									
YA362N-90	3					3.81"	1.69"	90 Degree									
YA362TC38	1			3/8"	1"	5.59"	1.74"	Straight									
YA362TC38-45	2					5.17"	1.74"	45 Degree									
YA362TC38-90	3					2.81"	1.74"	90 Degree									
YA372N	1	650 kcmil	-	1/2"	1-3/4"	6.74"	1.80"	Straight	-	-	-	U37RT (4)	Orange	23	2-7/8"		
YA372N-45	2					6.29"	1.80"	45 Degree									
YA372N-90	3					3.84"	1.80"	90 Degree									
YA382N	1	700 kcmil	-	1/2"	1-3/4"	6.77"	1.84"	Straight	-	-	-	U38RT (4)	Pink	400	2-7/8"		
YA382N-45	2					6.29"	1.84"	45 Degree									
YA382N-90	3					3.84"	1.84"	90 Degree									
YA382TC38	1			3/8"	1"	5.76"	1.84"	Straight									
YA382TC38-45	2					5.29"	1.84"	45 Degree									
YA382TC38-90	3					2.84"	1.84"	90 Degree									
YA392N	1	750 kcmil	-	1/2"	1-3/4"	6.87"	1.89"	Straight	-	-	-	U39RT (4) P39RT (4) **	Black	24	2-3/4"		
YA392N-45	2					6.38"	1.89"	45 Degree									
YA392N-90	3					3.87"	1.89"	90 Degree									
YA392NT38	1			3/8"	1"	5.87"	1.63"	Straight									
YA392NT38-45	2					5.38"	1.63"	45 Degree									
YA392NT38-90	3					2.87"	1.63"	90 Degree									
YA392TC38	1			3/8"	1"	5.87"	1.91"	Straight									
YA392TC38-45	2					5.38"	1.91"	45 Degree									
YA392TC38-90	3					2.87"	1.91"	90 Degree									
YA402N	1	800 kcmil	400	1/2"	1-3/4"	6.95"	1.95"	Straight	-	-	-	P40RT (4) **	Orange	25	3"		
YA402N-45	2					6.50"	1.95"	45 Degree									
YA402N-90	3					3.91"	1.95"	90 Degree									
YA412N	1	850 kcmil	-	1/2"	1-3/4"	6.96"	2.01"	Straight	-	-	-	-	Gold	26	3"		
YA412N-45	2					6.52"	2.01"	45 Degree									
YA412N-90	3					3.93"	2.01"	90 Degree									

* Use P-UADP-1 adaptor with "U" -dies in Y46 HYPRESS™.
 ** P-RT die sets for use in Y46 HYPRESS™ only, P-UADP-1 adaptor not required.
 *** The MM² conductor sizes listed are the recommendations for Class 2 conductor.

" Available undrilled. Add suffix "U" to catalog number. (Example: YA25U).
 ▲ See tooling section of this catalog for complete tool and die listings.

◆ For applications greater than 2000 Volts consult cable manufacturer for voltage stress relief instructions.



TWO HOLE HYLUG™ CODE CONDUCTOR LONG BARREL (CONTINUED)

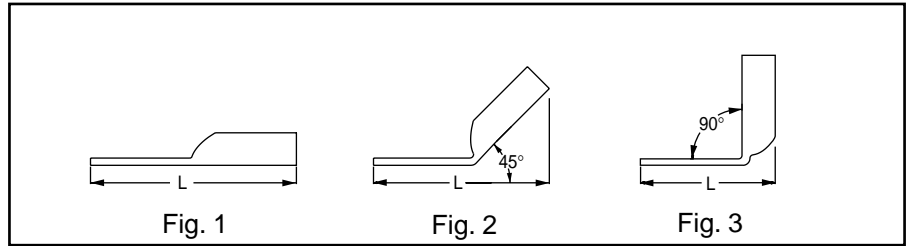

Catalog Number	Fig #	Conductor		Stud Hole Size	Stud Hole Spacing	L	Tongue Width	Tongue Angle	Installation Tooling				WIRE STRIP LENGTH		
		AWG	*** MM ²						Mechanical		Hydraulic			COLOR CODE	DIE INDEX
									Y1MRTC Y2MR	MD7-34R	BCT500 Y500CT	Y750-2/Y46C* BAT-750C			
YA442N	1	1000 kcmil	500	1/2"	1-3/4"	7.14"	2.17"	Straight	-	-	-	P44RT (4)	White	27	3-1/16"
YA442N-45	2					6.71"	2.17"	45 Degree							
YA442N-90	3					4.02"	2.17"	90 Degree							
YA442TC38	1			3/8"	1"	6.14"	2.19"	Straight							
YA442TC38-45	2					5.71"	2.19"	45 Degree							
YA442TC38-90	3					3.02"	2.19"	90 Degree							
YA-452N	1	1250 kcmil	-	1/2"	1-3/4"	7.44"	2.46"	Straight	-	-	-	P45RT (6) **	Yellow	29	3-1/4"
YA-452N-45	2					7.03"	2.46"	45 Degree							
YA-452N-90	3					4.13"	2.46"	90 Degree							
YA-4532N	1	1300 kcmil	-	1/2"	1-3/4"	7.48"	2.53"	Straight	-	-	-	-	Orange	30	2-1/16"
YA-4532N-45	2					7.07"	2.53"	45 Degree							
YA-4532N-90	3					4.16"	2.53"	90 Degree							
YA462N	1	1500 kcmil	-	1/2"	1-3/4"	7.55"	2.67"	Straight	-	-	-	P46RT (6) **	Green	31	3-1/4"
YA462N-45	2					7.15"	2.67"	45 Degree							
YA462N-90	3					4.22"	2.67"	90 Degree							
YA472N	1	1750 kcmil	-	1/2"	1-3/4"	7.89"	2.90"	Straight	-	-	-	-	Gray	33	3-1/2"
YA472N-45	2					7.45"	2.90"	45 Degree							
YA472N-90	3					4.30"	2.90"	90 Degree							
YA482N	1	2000 kcmil	-	1/2"	1-3/4"	7.98"	3.10"	Straight	-	-	-	-	Brown	34	3-1/2"
YA482N-45	2					7.60"	3.10"	45 Degree							
YA482N-90	3					4.40"	3.10"	90 Degree							

* Use P-UADP-1 adaptor with "U" -dies in Y46 HYPRESS™.
 ** P-RT die sets for use in Y46 HYPRESS™ only, P-UADP-1 adaptor not required.
 *** The MM² conductor sizes listed are the recommendations for Class 2 conductor.
 " Available undrilled. Add suffix "U" to catalog number. (Example: YA25U).
 ▲ See tooling section of this catalog for complete tool and die listings.
 ◆ For applications greater than 2000 Volts consult cable manufacturer for voltage stress relief instructions.