

ROTARY DIP SWITCHES

A-25-31

DR Series/Rotary Dip Switch • RR Series/Rotary Dip Switch w/Integral Resistors
RA/C Series/Rotary Dip Switch with Integral Diodes

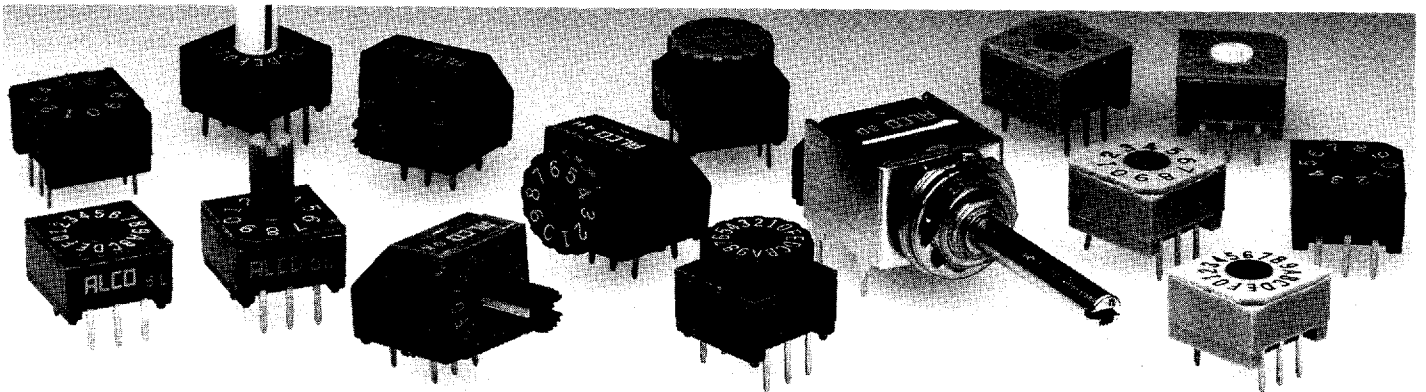

SPECIFICATIONS

ELECTRICAL

Contact Rating 0.4VA at 20VDC max.
Initial Contact Resistance 50 milliohms max. at 20VDC
Insulation Resistance 1,000 megohms min. at 100VDC
Dielectric Strength 300VAC RMS at sea level

MECHANICAL

Operating Force 6 oz.-in. nom.
Surface Mount Operating Force 3 oz.-in. nom.
Life Expectancy 10,000 Rotations
Actuator Strength (DRM) 5.0 lbs. max. lateral force

MATERIALS

Base, Rotor and Case glass-filled PBT resin
Contact/Terminals gold flashed brass
Movable Contact gold flashed Beryllium copper
Ball Support Plate phosphor bronze
Detent Spring stainless steel (spring)
Bushing (DRS) zinc die-casting
Shaft (DRS) nickel plated brass

ENVIRONMENTAL

Operating Temperature -30°C to +85°C
Storage Temperature -45°C to +100°C
Vibration Resistance subjected to vibration of 10-55hz per second with a total amplitude of .06 in. in 3 mutually perpendicular directions for 2 hours each.

Shock Resistance will withstand 50G acceleration in 3 different planes for a period of 11 milliseconds

Salt Spray Test withstands an atmosphere of 5% salt water at temperature of 50°C

Hydrogen Sulfide Test withstands an atmosphere of 15-20 PPM hydrogen sulfide gas at temperature of 40°C for 240 hours

Atmospheric Test withstands an atmosphere of 30-50 PPM sulfite gas at a temperature of 40°C for 240 hours

Solder Heat Resistance withstands 5 sec. flow solder bath of 285°C when mounted on a .06" thick PC board

Cleaning Test withstands ultrasonic cleaning in a 10% flux contaminated solvent solution

TRUTH TABLES

Terminal Identification
(view from bottom of the switch)

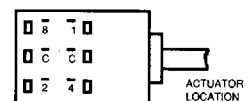
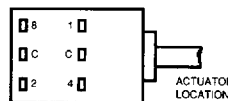
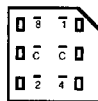
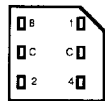

FOR HYBRID VERSIONS, COMMON BETWEEN TERMINALS 1 AND 4 IS RESISTOR OR DIODE COMMON.

10 - POSITION, BCD (red)

Pos.	0	1	2	3	4	5	6	7	8	9
C	X	X	X	X	X	X	X	X	X	X
1		X		X		X		X		X
2			X	X			X	X		
4					X	X	X	X		
8									X	X

16 - POSITION, HEXADECIMAL (black)

Pos.	0	1	2	3	4	5	6	7	8	9	A	B	C	D	E	F
C	X	X	X	X	X	X	X	X	X	X	X	X	X	X	X	X
1		X		X		X		X		X		X		X		X
2			X	X			X	X			X	X			X	X
4					X	X	X	X					X	X	X	X
8									X	X	X	X	X	X	X	X

BCD COMPLEMENT (orange)

Pos.	0	1	2	3	4	5	6	7	8	9
C	X	X	X	X	X	X	X	X	X	X
1	X		X		X		X		X	
2	X	X			X	X			X	X
4	X	X	X	X					X	X
8	X	X	X	X	X	X	X	X		

16 - POSITION HEXADECIMAL (black)

Pos.	0	1	2	3	4	5	6	7	8	9	A	B	C	D	E	F
C	X	X	X	X	X	X	X	X	X	X	X	X	X	X	X	X
1	X		X		X		X		X		X		X		X	
2	X	X			X	X			X	X			X	X		
4	X	X	X	X					X	X	X	X				
8	X	X	X	X	X	X	X	X								

NOTE: COMMON TERMINALS ARE CONNECTED INTERNALLY, EXCEPT ON HYBRID VERSIONS.

SPECIFICATIONS SUBJECT TO CHANGE WITHOUT NOTICE.



Alcoswitch®

1551 Osgood Street

N. Andover, MA 01845 USA

Tel: (508)685-4371

FAX: (508)686-9545

TLX: 275423

DR, RR & RA/C SERIES

Rotary Dip Switches

A-25-31

"D" FLUSH ACTUATOR

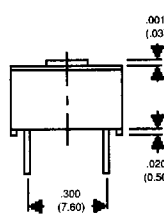
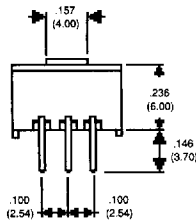
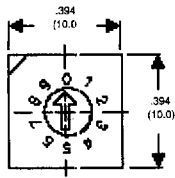

SURFACE MOUNT TERMINATIONS

S

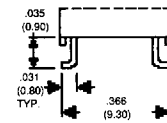

SA

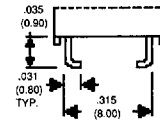

SB

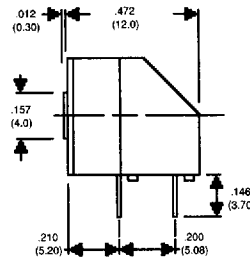
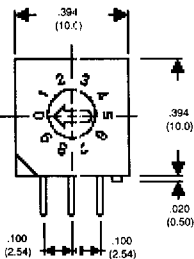
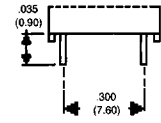

SURFACE MOUNT TERMINATIONS

RAS

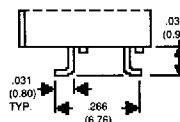

RASA

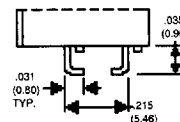

RASB

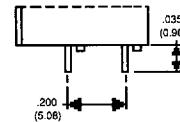

"M" MINI-SHAFT ACTUATOR

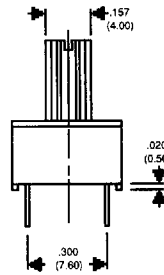
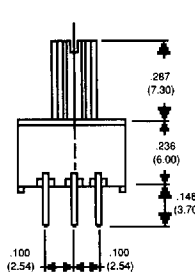
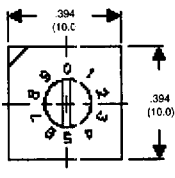

SURFACE MOUNT TERMINATIONS

S

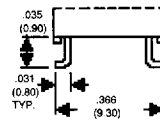

SA

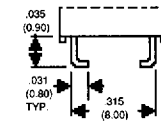

SB

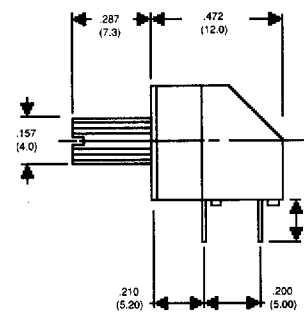
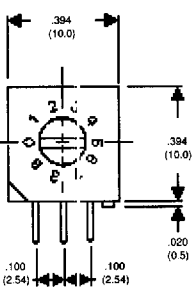
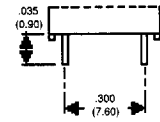

SURFACE MOUNT TERMINATIONS

RAS

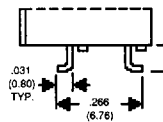

RASA

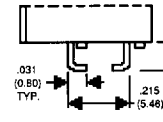

RASB

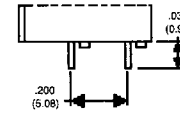

PAD LAYOUTS

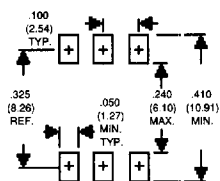

S
OUTSIDE 'L'

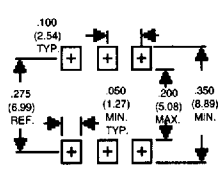

SA
INSIDE 'L'

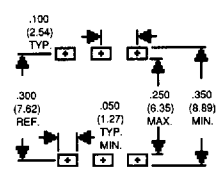

SB
BUTT

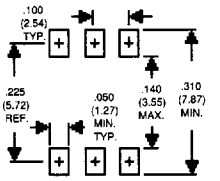

RAS
OUTSIDE 'L'

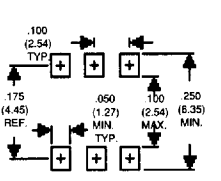

RASA
INSIDE 'L'

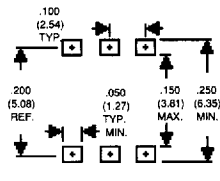

RASB
BUTT

SPECIFICATIONS SUBJECT TO CHANGE WITHOUT NOTICE.



Alcoswitch®

1551 Osgood Street

N. Andover, MA 01845 USA

Tel: (508)685-4371

FAX: (508)686-9545

TLX: 275423

DR, RR & RA/C SERIES

Rotary Dip Switches

A-25-31

"S" METAL SHAFT ACTUATOR

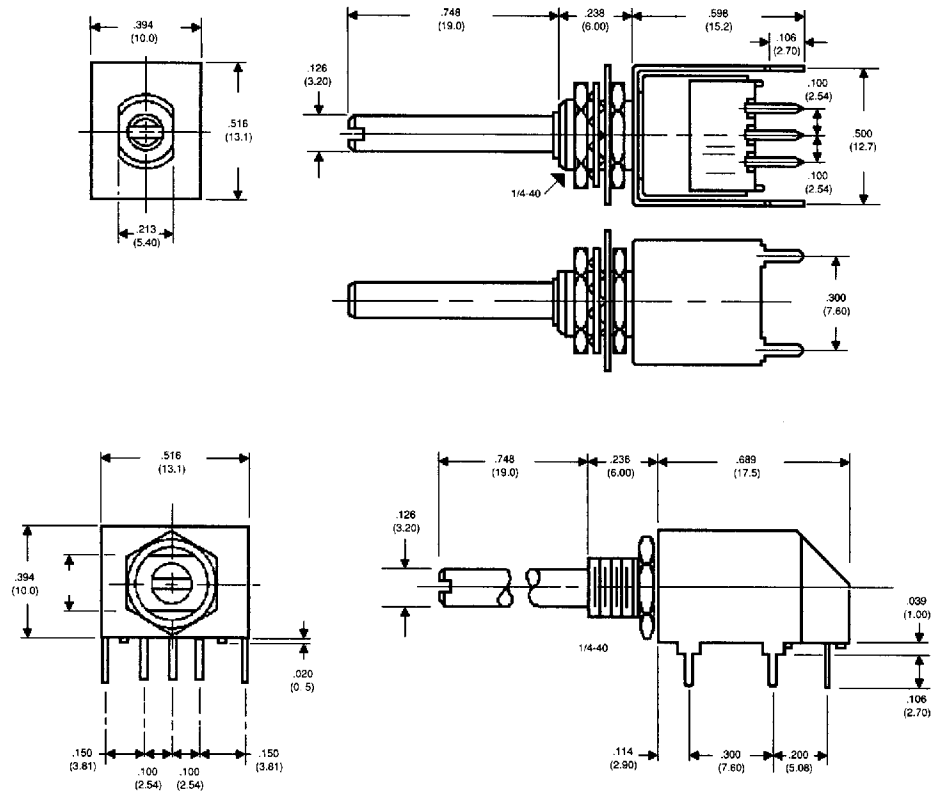

"W" WHEEL ACTUATOR

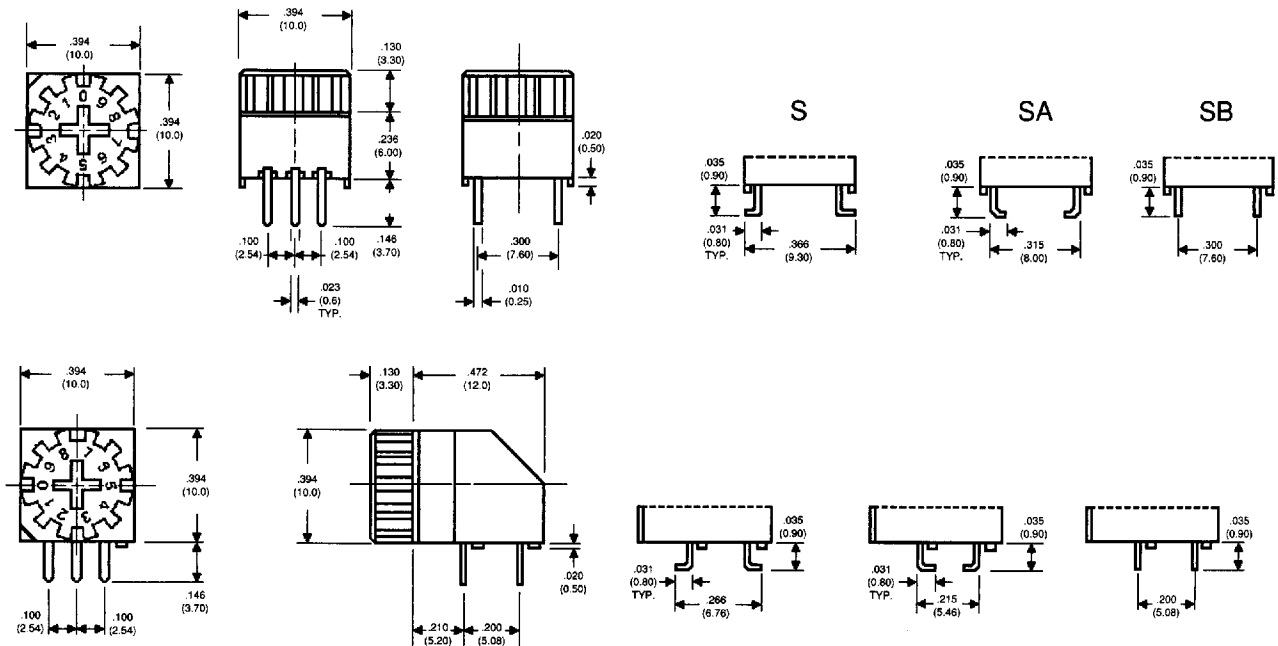

SPECIFICATIONS SUBJECT TO CHANGE WITHOUT NOTICE.

SOLDERING PROCESS RECOMMENDATION GUIDE

AUGAT/ INTCON PRDT GP

49E D ■ 1095335 0001533 628 ■ AUIP ○

The majority of customers utilizing miniature or sub miniature switches in the industry today have a great concern about the switches capabilities during their soldering and cleaning cycles. This concern centers around the introduction of contaminants into the switch contact area which could cause the switch to experience various failure modes either immediately or during the life cycle of the switches usage. These failure modes can show in a number of manners. The following are just a few examples: high contact resistance, open contacts, low dielectric strength breakdown, and high actuation forces causing use related applications to malfunction. Since most fluxes become active with the introduction of the high temperatures used in all soldering techniques, the switch must either prevent these fluxes from entering into its contact area or allow cleaning techniques to carry flux particles out. It must be understood that switch contamination can occur during any procedure: from hand soldering to the new age Surface Mount systems using vapor phase, I.R., or Convection chambers for solder reflow.

We at Augat/Alcoswitch offer a wide range of switches to handle any soldering operations. However, certain soldering conditions will not apply to all switches. The following conditions and charts should help assist you in the soldering of our switches in your application. If you need additional information, feel free to contact the factory.

SOLDERING TYPES

A. Wave Soldering:

Top & Bottom board preheats: 200°F(93°C) for approximately 3 to 4 minutes.
Solder Temperature and Dwell Time: 500°F(260°C) for approximately 3 to 5 seconds.

B. Hand Soldering

1. 500°F-600°F(260°C-316°C)utilizing a controlled 40 Watt iron for 3 to 5 seconds maximum.
2. 500°F(260°C) utilizing a controlled 30 Watt iron for 10 seconds maximum.

C. Dip Soldering

Solder Temperature & Dwell Time: 500°F(260°C) for 10 seconds maximum.

D.Surface Mount

1. Convection IR
Zone 1 = 212°F(100°C) for 120 seconds maximum.
Zone 2 = 419°F(215°C) is reaches in approximately 160 seconds after zone 1, and held at that temperature for approximately 10 seconds.
2. Radiant IR
Zones 1 & 2 combined = 330°F(166°C) maximum with a total run of 210°C(99°C) seconds.
Zone 3 & 4 combined = 460°F(238°C) is reached in approximately 30 seconds after zones 1 & 2 and held at that temperature for approximately 10 seconds.
3. Vapor Phase
Zone 1 = 140°F (60°C) for 15 seconds.
Zone 2 = 419°F(215°C) for 30 seconds.

CLEANING TYPES

- A. Solvent Wash (1.1.1 Trichlorethylene, T.M.S., T.M.C.)
- B. Vapor Degreasing
- C. Solvent Immersion
- D. Aqueous Cleaning

SPECIFICATIONS SUBJECT TO CHANGE WITHOUT NOTICE.

SOLDERING PROCESS RECOMMENDATION GUIDE

SWITCH SERIES	SOLDERING TYPE			SURFACE MOUNT PROCESS			CLEANING PROCESSES			
	Wave	Hand	Dip*	Convection I.R.	Radiant I.R.	Vapor Phase	Solvent Wash	Vapor Degrease	Solvent Immerse	Aqueous Clean
ALCO ®										
AP, AT, AS SERIES	X	X	X				X			X
ALE,ATLE,ATE,APBE	X	X	X				X	X	X	X
ASE & F	X	X	X	X	X	X	X	X	X	X
COMMAND SERIES, PC	X	X								
COMMAND SERIES, LUGS		X								
CST/CSS SERIES	X	X	X				X	X	X	X
DIP ROT.: DR,RR &RA/C	X	X	X				X	X	X	X
DIP ROT.: DRS SERIES	X	X	X				X	X		X
DIPS:AD,AR,AA/C,ATT	X	X	X	X		X	X	X	X	X
DIPS:DP SERIES W/O TAPE		X	X				X			
DIPS:DP SERIES W/TAPE	X	X	X				X	X	X	X
DIPS:DTS WITH TAPE	X	X	X				X	X	X	X
DIPS:DTS,DYS W/O TAPE		X	X				X			
DIPS:S SERIES SIPS	X	X	X	X		X	X	X	X	X
DIPS:DPT WITH TAPE	X	X	X				X	X	X	X
DIPS:DPU WITHOUT TAPE		X	X							
DIPS:DSS101	X	X	X							
FSB1, FSB2		X	X							
FSM SERIES		X								
FT2D,FT1D	X	X	X				X	X	X	X
GEMINI: A SERIES	X	X	X				X			
GEMINI: AE SERIES	X	X	X				X	X	X	X
GREEN SERIES: ALL MT VERSIONS		X	X				X	X		
GREEN SERIES: ALL MT VERSIONS PC	X	X	X				X			
GREEN SERIES: MHV,MRV,MLD		X	X				X	X		
GREEN SERIES: MPA-6,MPG,MPN,MPE		X	X				X	X		
GREEN SERIES: MTE		X	X				X	X		
LVP/LHP SERIES	X	X	X							
MAS SERIES		X	X					X	X	
MHS SERIES	X	X	X				X	X	X	X
MKS SERIES	X	X	X				X	X	X	
MLP SERIES		X	X				X			
MM-9 SERIES		X	X							
MMS SERIES		X	X				X	X		
MPA-3 SERIES		X	X				X	X		
MPA-6 SERIES		X	X				X			
MPB SERIES		X	X				X	X		
MPN SERIES		X	X				X			
MPS SERIES		X	X				X	X		
MRBA SERIES		X	X				X	X		
MRC SERIES		X	X				X	X		
MRJ SERIES	X	X	X				X			
MRJE/MRJB SERIES	X	X	X				X	X	X	X
MRS SERIES	X	X	X				X	X		X

SPECIFICATIONS SUBJECT TO CHANGE WITHOUT NOTICE.



SOLDERING PROCESS RECOMMENDATION GUIDE

SWITCH SERIES	SOLDERING TYPE			SURFACE MOUNT PROCESS			CLEANING PROCESSES			
	Wave	Hand	Dip*	Convection I.R.	Radiant I.R.	Vapor Phase	Solvent Wash	Vapor Degrease	Solvent Immerse	Aqueous Clean
MRS-RA SERIES	X	X	X				X	X		
MRSB SERIES	X	X	X				X	X	X	X
MRSK SERIES		X	X				X	X		
MSP-3 /MSPS SERIES		X	X							
MSP-5 SERIES		X	X				X	X		
MSPF SERIES		X	X				X	X		
MSPM SERIES		X	X				X	X		
MSS SERIES	X	X	X				X	X	X	X
MSSA SERIES	X	X	X				X	X	X	X
MSSA-01 & 04	X	X	X				X	X	X	X
PBL SERIES	X									X
PUSHWHEELS, CARD EDGE		X								
PUSHWHEELS, PC PINS	X	X	X							
QAS SERIES		X	X				X			
SC CIRCUIT BREAKERS	X	X								
SDS SERIES	X	X	X				X	X	X	X
SE SERIES	X	X	X				X	X	X	X
SKC SERIES		X								
SKF SERIES		X								
SKFC1		X	X				X	X		
SKFC2L		X								
SKT SERIES		X	X				X	X		
SL SERIES	X	X	X				X	X	X	
SLS/SLSA SERIES	X	X	X				X	X	X	
SMT/SMP:PC,PCV,RA,VRA	X	X	X				X	X	X	X
SMT/SMP:SPC,SRA,SRAB				X	X	X	X	X	X	X
SSA/SSJ SERIES	X	X	X				X	X		
SSB SERIES	X	X	X				X	X	X	X
SSM SERIES	X	X	X				X	X	X	X
STS SERIES	X	X	X				X	X	X	X
SWK SERIES		X								
TP SERIES: ALL PC/BLUE CASES	X									
TP SERIES:TP-ES	X	X	X				X	X	X	X
TP SERIES:W/TACT. FEEL & PROC. SEAL	X	X	X				X	X	X	X
TP SERIES:TPC,TPD,TPF,TP-N		X	X				X	X		
TP200 SERIES:TP1M,TP1L,TP2M,TP2L		X	X				X	X		
TR SERIES	X	X	X				X			
TRD	X	X	X				X			
TRD W/L.E.D.		X	X							
TS SERIES	X	X	X				X	X	X	X
TSS-PC, TSS-RA	X	X					X			
TT ALL PC/BLUE CASES	X	X					X			
TT,TTE-ES,TT-RA	X	X	X				X	X	X	X
TT,TTETT,TTE,TTN-WIRE LUG		X	X				X			
XR110, XR210, XRM		X								

SPECIFICATIONS SUBJECT TO CHANGE WITHOUT NOTICE.



Alcoswitch® 1551 Osgood Street N. Andover, MA 01845 USA Tel: (508)685-4371 FAX: (508)686-9545 TLX: 275423