

Product data sheet

Specifications



current measurement relay RM4-J - range 3..1000 mA - 24..240 V AC DC

RM4JA31MW

⚠ Discontinued on: Jan 23, 2021

⚠ Discontinued

Main

Range Of Product	Harmony Relay
Product Or Component Type	Industrial measurement and control relays
Relay Type	Current measurement relay
Relay Name	RM4J
Relay Monitored Parameters	Overcurrent or undercurrent detection
Time Delay	Adjustable 0.05...30 s
Maximum Power Consumption In Va	3.3 VA AC
Measurement Range	0.3...30 mA current DC 10...100 mA current DC 100...1000 mA current DC 0.3...30 mA current AC 10...100 mA current AC 100...1000 mA current AC
Contacts Type And Composition	2 C/O

Complementary

Maximum Switching Voltage	440 V AC
[Us] Rated Supply Voltage	24...240 V AC 50/60 Hz +/- 5 % 24...240 V DC
Operating Voltage Tolerance	0.85...1.1 Uc
Maximum Power Consumption In W	1.2 W DC
Output Contacts	2 C/O
Maximum Measuring Cycle	80 ms
Internal Input Resistance	10 Ohm 33 Ohm 1 Ohm
Permissible Continuous Overload	0.15 A 1.5 A 0.05 A
Permissible Non Repetitive Overload	5 A 0.2 A 0.5 A
Setting Accuracy Of The Switching Threshold	+/-5 %
Switching Threshold Drift	<= 0.06 % per degree centigrade depending permissible ambient air temperature <= 0.5 % within the supply voltage range (0.85...1.1 Un)
Setting Accuracy Of Time Delay	10 P

Price is "List Price" and may be subject to a trade discount – check with your local distributor or retailer for actual price.

Time Delay Drift	<= 0.07 % per degree centigrade depending on temperature <= 0.5 % within the supply voltage range (0.85...1.1 Un)
Hysteresis	5...30 % adjustable current threshold setting
Marking	CE : EMC 89/336/EEC CE : LVD 73/23/EEC
Overvoltage Category	III IEC 60664-1
[Ui] Rated Insulation Voltage	500 V IEC
Supply Disconnection Value	> 0.1 Uc
Operating Position	Any position without derating
Connections - Terminals	Screw terminals, 2 x 1.5 mm ² flexible with cable end Screw terminals, 2 x 2.5 mm ² flexible without cable end
Tightening Torque	5.31...9.74 lbf.in (0.6...1.1 N.m)
Mechanical Durability	30000000 cycles
[Ith] Conventional Free Air Thermal Current	8 A
[Ie] Rated Operational Current	2 A 24 V DC-13 158 °F (70 °C) IEC 60947-5-1/1991 2 A 24 V DC-13 158 °F (70 °C) VDE 0660 3 A 115 V AC-15 158 °F (70 °C) IEC 60947-5-1/1991 3 A 115 V AC-15 158 °F (70 °C) VDE 0660 3 A 24 V AC-15 158 °F (70 °C) IEC 60947-5-1/1991 3 A 24 V AC-15 158 °F (70 °C) VDE 0660 3 A 250 V AC-15 158 °F (70 °C) IEC 60947-5-1/1991 3 A 250 V AC-15 158 °F (70 °C) VDE 0660 0.1 A 250 V DC-13 158 °F (70 °C) IEC 60947-5-1/1991 0.1 A 250 V DC-13 158 °F (70 °C) VDE 0660 0.3 A 115 V DC-13 158 °F (70 °C) IEC 60947-5-1/1991 0.3 A 115 V DC-13 158 °F (70 °C) VDE 0660
Switching Capacity In Ma	10 mA 12 V
Switching Voltage	250 V AC
Contacts Material	90/10 silver nickel contacts
Number Of Cables	2
Width	0.91 in (23 mm)
Height	3.07 in (78 mm)
Depth	3.15 in (80 mm)
Terminals Description Iso N°1	(25-26-28)OC (C-B1-B2-B3)CO (15-16-18)OC (A1-A2)CO
Output Relay State	Tripped if A measured > A set Tripped if V measured > V set
9 Mm Pitches	2.5
Net Weight	0.38 lb(US) (0.172 kg)

Environment

Electromagnetic Compatibility	Electrostatic discharge - test level: 6 kV level 3 (contact discharge) conforming to IEC 61000-4-2 Electrostatic discharge - test level: 8 kV level 3 (air discharge) conforming to IEC 61000-4-2
Standards	EN/IEC 60255-6
Product Certifications	CSA GL UL
Ambient Air Temperature For Storage	-40...185 °F (-40...85 °C)

Ambient Air Temperature For Operation	-4...149 °F (-20...65 °C)
Environmental Characteristic	3K3
Relative Humidity	15...85 % IEC 60721-3-3
Shock Resistance	15 gn 11 ms IEC 60255-21-1
Ip Degree Of Protection	IP20 IEC 60529 terminals) IP50 IEC 60529 casing)
Pollution Degree	3 IEC 60664-1
Dielectric Test Voltage	2.5 kV
Non-Dissipating Shock Wave	4.8 kV
Resistance To Electrostatic Discharge	6 kV contact IEC 61000-4-2 level 3 8 kV air IEC 61000-4-2 level 3
Resistance To Electromagnetic Fields	9.14 V/m (10 V/m) IEC 61000-4-3 level 3
Resistance To Fast Transients	2 kV IEC 61000-4-4 level 3
Protection Against Electric Shocks	2 kV level 3 IEC 61000-4-5
Disturbance Radiated/Conducted	CISPR 22 - class A CISPR 11 group 1 - class A

Ordering and shipping details

Category	22376-RELAYS-MEASUREMENT(RM4)
Discount Schedule	CP2
Gtin	00785901195092
Returnability	No
Country Of Origin	ID

Packing Units

Unit Type Of Package 1	PCE
Number Of Units In Package 1	1

Contractual warranty

Warranty	18 months
-----------------	-----------

Dimensions

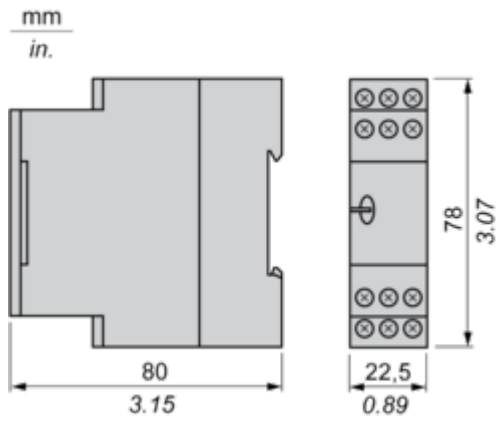

Current Measurement Relays

Rail mounting

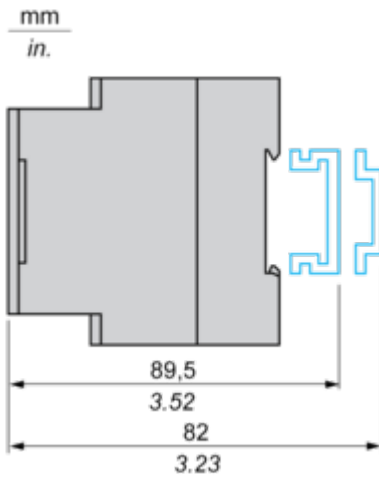

Screw fixing

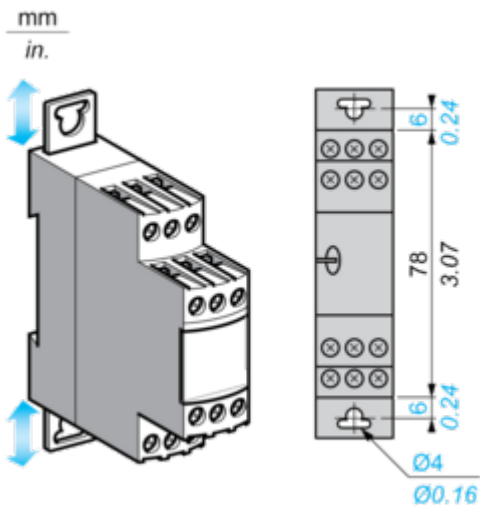

Current Measurement Relays

RM4JA01 Wiring Diagram

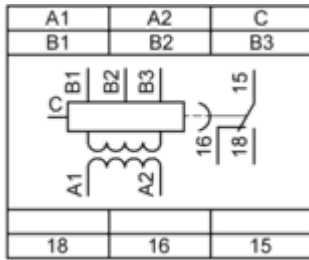

A1-A2 Supply voltage

B1, B2, B3, C Currents to be measured (see table below)

Connection and current values to be measured	
B1-C	3...30 mA
B2-C	10...100 mA
B3-C	0.1...1 A

RM4JA31 Wiring Diagram

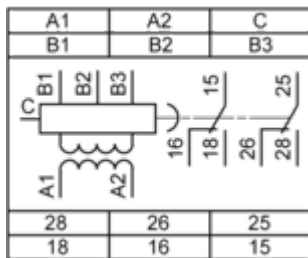

A1-A2 Supply voltage

B1, B2, B3, C Currents to be measured (see table below)

Connection and current values to be measured	
B1-C	3...30 mA
B2-C	10...100 mA
B3-C	0.1...1 A

RM4JA32 Wiring Diagram

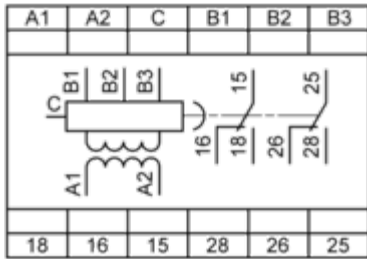

A1-A2 Supply voltage

B1, B2, B3, C Currents to be measured (see table below)

Connection and current values to be measured	
B1-C	0.3...1.5 A
B2-C	1...5 A
B3-C	3...15 A

Application Schemes

Example: Detection of Blockage on a Crusher (Overcurrent Function)

Current measured ≤ 15 A

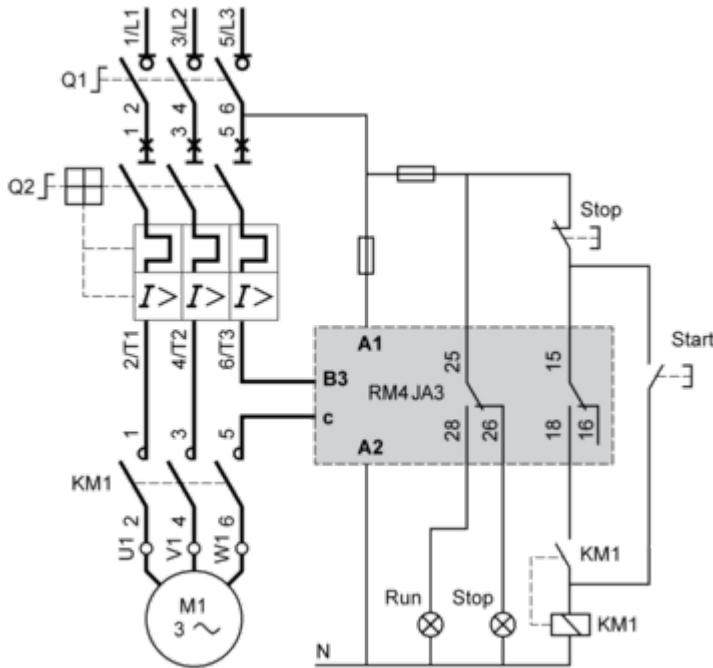

Current measured > 15 A

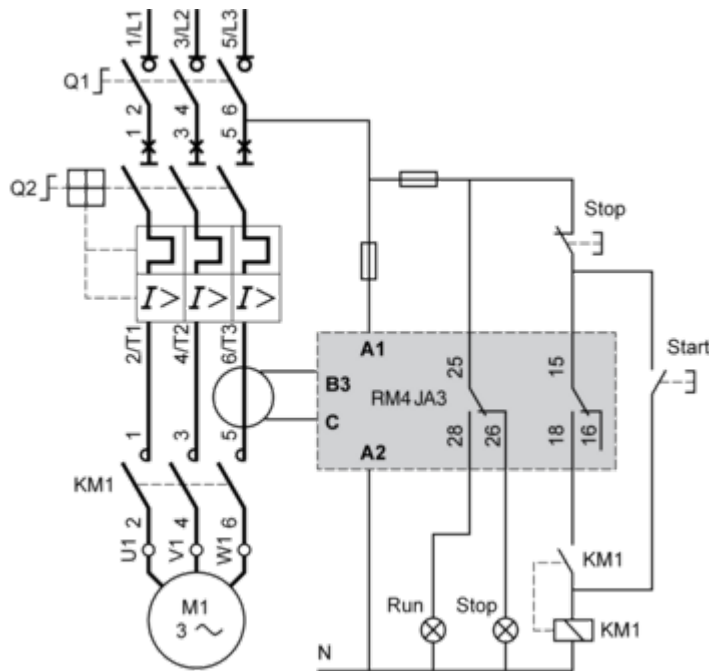

Performance Curves

Electrical Durability and Load Limit Curves

AC Load

Curve 1: Electrical durability of contacts on resistive load in millions of operating cycles

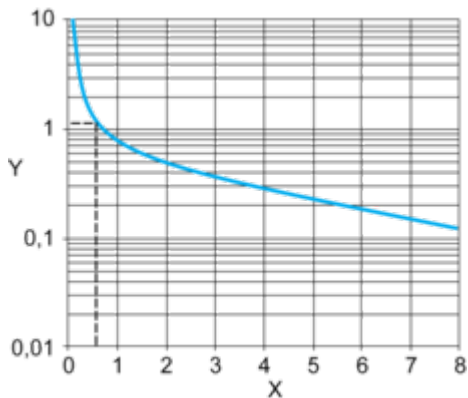

X Current broken in A

Y Millions of operating cycles

Curve 2: Reduction factor k for inductive loads (applies to values taken from durability Curve 1)

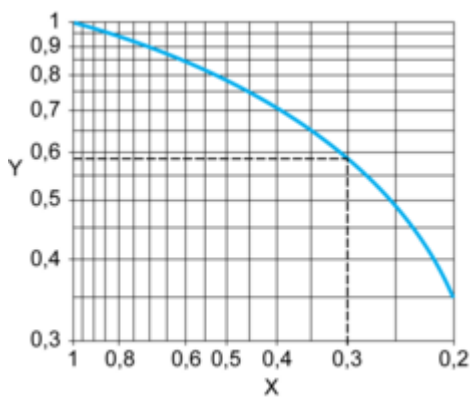

X Power factor on breaking ($\cos \varphi$)

Y Reduction factor K

DC Load

Load limit curve

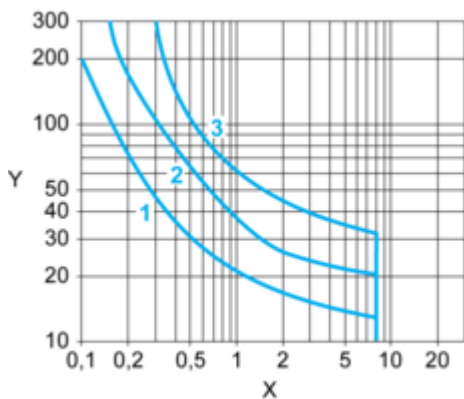

X Current in A

Y Voltage in V

1 L/R = 20 ms

2 L/R with load protection diode

3 Resistive load

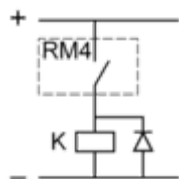

Function Diagram

Overcurrent Detection

Function ">"

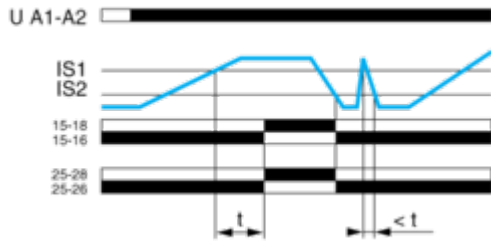

Legend

t Time delay

U A1-A2 Supply voltage

IS1 Setting current threshold

IS2 Current measured

15-18, 15-16; 25-28, 25-26 Output relays connections

Relay status: black color = energized.

Function Diagram

Undercurrent Detection

Function “<”

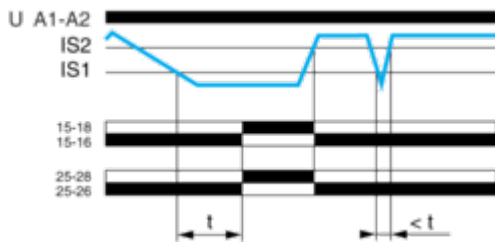

Legend

t Time delay

U A1-A2 Supply voltage

IS1 Setting current threshold

IS2 Current measured

15-18, 15-16; 25-28, 25-26 Output relays connections

Relay status: black color = energized.