

EC11 Series

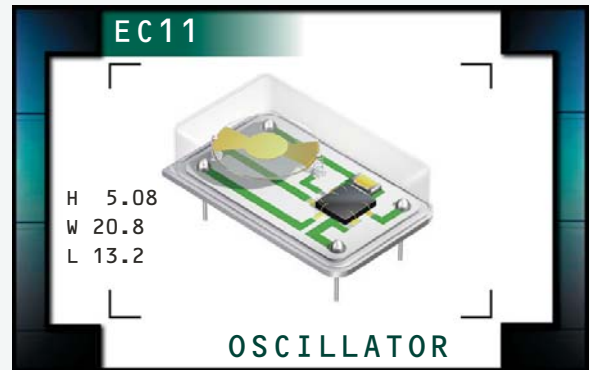

ECLIPTEK[®]
CORPORATION

- RoHS Compliant (Pb-free)
- HCMOS/TTL output
- 5.0V supply voltage
- 14 pin DIP package
- Stability to ± 20 ppm
- Custom lead length, gull wing options available



ELECTRICAL SPECIFICATIONS

Frequency Range (MHz)		0.250MHz to 106.250MHz
Operating Temperature Range		0°C to 70°C or -40°C to 85°C
Storage Temperature Range		-55°C to 125°C
Supply Voltage (V_{DD})		5.0V _{DC} $\pm 10\%$
Input Current	250.000kHz to 24.000MHz	45mA Maximum
	24.001MHz to 50.000MHz	55mA Maximum
	50.001MHz to 66.667MHz	65mA Maximum
	66.668MHz to 106.250MHz	85mA Maximum
Frequency Tolerance / Stability	Inclusive of Operating Temperature Range, Supply Voltage, and Load	± 100 ppm, ± 50 ppm, ± 25 ppm, or ± 20 ppm Max. (0°C to 70°C Only)
Output Voltage Logic High (V_{OH})	w/TTL Load	2.4V _{DC} Minimum
	w/HCMOS Load	$V_{DD} - 0.5V_{DC}$ Minimum
Output Voltage Logic Low (V_{OL})	w/TTL Load	0.4V _{DC} Maximum
	w/HCMOS Load	0.5V _{DC} Maximum
Rise Time / Fall Time	0.4V _{DC} to 2.4V _{DC} w/TTL Load; 20% to 80% of Waveform w/HCMOS Load	6 nSeconds Maximum
Duty Cycle	at 1.4V _{DC} w/TTL Load; at 50% of Waveform w/HCMOS Load	50 ± 10 (%) (Standard)
	at 1.4V _{DC} w/TTL Load or w/HCMOS Load ≤ 70.000 MHz	50 ± 5 (%) (Optional)
	at 50% of Waveform w/TTL Load or w/HCMOS Load > 70.000 MHz	50 ± 5 (%) (Optional)
Load Drive Capability	250.000kHz to 24.000MHz	10TTL Load or 50pF HCMOS Load
	24.001MHz to 70.000MHz	10TTL Load or 15pF HCMOS Load
	70.001MHz to 106.250MHz	10LSTTL Load or 15pF HCMOS Load
Tri-State Input Voltage	V_{IH} : No Connection	Enables Output
	V_{IH} : $\geq 2.2V_{DC}$	Enables Output
	V_{IL} : $\leq 0.8V_{DC}$	Disables Output: High Impedance
Aging (at 25°C)		± 5 ppm / year Maximum
Start Up Time		10mSeconds Maximum
Period Jitter: Absolute		± 100 pSeconds Maximum
Period Jitter: One Sigma		± 25 pSeconds Maximum

MANUFACTURER
ECLIPTEK CORP.

CATEGORY
OSCILLATOR

SERIES
EC11

PACKAGE
14 pin DIP

VOLTAGE
5.0V

CLASS
OS04

REV. DATE
08/06

PART NUMBERING GUIDE

EC11 00 ETTTS - 60.000M - G

FREQUENCY TOLERANCE / STABILITY

00=±100ppm Max. (Standard), 45=±50ppm Max.
25=±25ppm Max., 20=±20ppm Max.

OPERATING TEMP. RANGE

Blank=0°C to 70°C (Standard), ET=-40°C to 85°C

DUTY CYCLE

Blank=50 ±10(%) (Standard), T=50 ±5(%)

AVAILABLE OPTIONS

Blank=None (Standard)
CLXXX=Custom Lead Length (See Page 133)
G=Full Size Gull Wing (See Page 132)

FREQUENCY

K=kHz, M=MHz

OUTPUT CONTROL FUNCTION

Blank=None (No Connection on Pin 1)
TS=Tri-State Enable High

NOTES

MECHANICAL DIMENSIONS
ALL DIMENSIONS IN MILLIMETERS

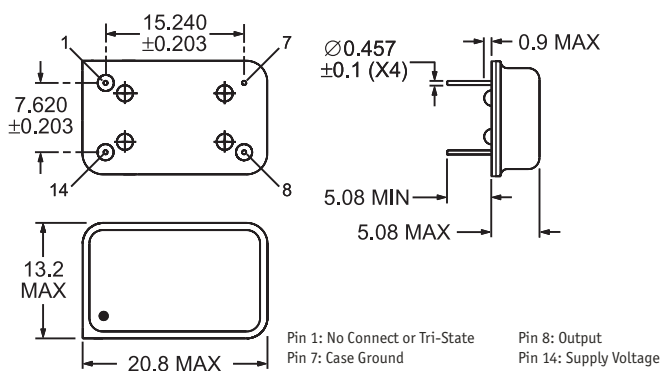

MARKING SPECIFICATIONS

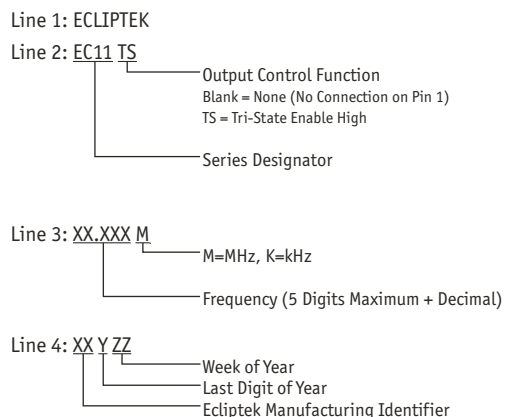

Note: Pin 1 shall be designated with a dot

ENVIRONMENTAL/MECHANICAL SPECIFICATIONS

Characteristic	Specification
Fine Leak Test	MIL-STD-883, Method 1014, Condition A
Gross Leak Test	MIL-STD-883, Method 1014, Condition C
Mechanical Shock	MIL-STD-202, Method 213, Condition C
Vibration	MIL-STD-883, Method 2007, Condition A
Lead Integrity	MIL-STD-883, Method 2004

Characteristic	Specification
Solderability	MIL-STD-883, Method 2002
Temperature Cycling	MIL-STD-883, Method 1010
Resistance to Soldering Heat	MIL-STD-883, Method 210
Resistance to Solvents	MIL-STD-883, Method 215

MANUFACTURER	CATEGORY	SERIES	PACKAGE	VOLTAGE	CLASS	REV. DATE
ECLIPTEK CORP.	OSCILLATOR	EC11	14 pin DIP	5.0V	OS04	08/06

EC11 Series

- RoHS Compliant (Pb-free)
- HCMOS/TTL output
- 5.0V supply voltage
- 8 pin DIP package
- Stability to ± 20 ppm
- Custom lead length, gull wing options available



ECLIPTEK[®]
CORPORATION

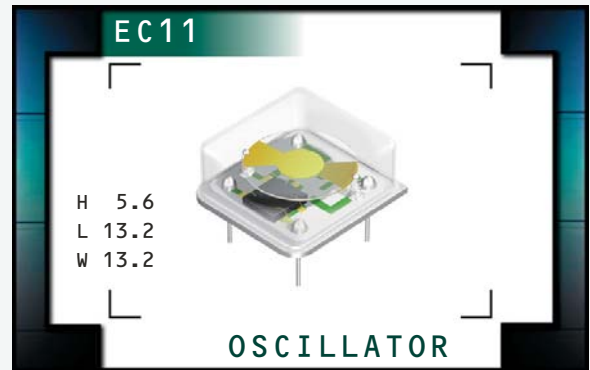

ELECTRICAL SPECIFICATIONS

Frequency Range (MHz)		0.250MHz to 106.250MHz
Operating Temperature Range		0°C to 70°C or -40°C to 85°C
Storage Temperature Range		-55°C to 125°C
Supply Voltage (V_{DD})		5.0V _{DC} $\pm 10\%$
Input Current	250.000kHz to 24.000MHz	45mA Maximum
	24.001MHz to 50.000MHz	55mA Maximum
	50.001MHz to 66.667MHz	65mA Maximum
	66.668MHz to 106.250MHz	85mA Maximum
Frequency Tolerance / Stability	Inclusive of Operating Temperature Range, Supply Voltage, and Load	± 100 ppm, ± 50 ppm, ± 25 ppm, or ± 20 ppm Max. (0°C to 70°C Only)
Output Voltage Logic High (V_{OH})	w/TTL Load	2.4V _{DC} Minimum
	w/HCMOS Load	$V_{DD} - 0.5V_{DC}$ Minimum
Output Voltage Logic Low (V_{OL})	w/TTL Load	0.4V _{DC} Maximum
	w/HCMOS Load	0.5V _{DC} Maximum
Rise Time / Fall Time	0.4V _{DC} to 2.4V _{DC} w/TTL Load; 20% to 80% of Waveform w/HCMOS Load	6 nSeconds Maximum
Duty Cycle	at 1.4V _{DC} w/TTL Load; at 50% of Waveform w/HCMOS Load	50 ± 10 (%) (Standard)
	at 1.4V _{DC} w/TTL Load or w/HCMOS Load ≤ 70.000 MHz	50 ± 5 (%) (Optional)
	at 50% of Waveform w/TTL Load or w/HCMOS Load > 70.000 MHz	50 ± 5 (%) (Optional)
Load Drive Capability	250.000kHz to 24.000MHz	10TTL Load or 50pF HCMOS Load
	24.001MHz to 70.000MHz	10TTL Load or 15pF HCMOS Load
	70.001MHz to 106.250MHz	10LSTTL Load or 15pF HCMOS Load
Tri-State Input Voltage	V_{IH} : No Connection	Enables Output
	$V_{IH} \geq 2.2V_{DC}$	Enables Output
	$V_{IL} \leq 0.8V_{DC}$	Disables Output: High Impedance
Aging (at 25°C)		± 5 ppm / year Maximum
Start Up Time		10mSeconds Maximum
Period Jitter: Absolute		± 100 pSeconds Maximum
Period Jitter: One Sigma		± 25 pSeconds Maximum

MANUFACTURER
ECLIPTEK CORP.

CATEGORY
OSCILLATOR

SERIES
EC11

PACKAGE
8 pin DIP

VOLTAGE
5.0V

CLASS
OS05

REV. DATE
08/06

PART NUMBERING GUIDE

EC11 00 HS ETTS - 60.000M - G TR

FREQUENCY TOLERANCE / STABILITY

00=±100ppm Max. (Standard), 45=±50ppm Max.
25=±25ppm Max., 20=±20ppm Max.

PACKAGE

HS=Half Size 8 Pin DIP

OPERATING TEMP. RANGE

Blank=0°C to 70°C (Standard), ET=-40°C to 85°C

DUTY CYCLE

Blank=50 ±10(%) (Standard), T=50 ±5(%)

OUTPUT CONTROL FUNCTION

Blank=None (No Connection on Pin 1), TS=Tri-State Enable High

PACKAGING OPTIONS

Blank=Bulk (Standard)
TR=Tape & Reel (only offered with
Half Size G and Half Size G2 Options)

AVAILABLE OPTIONS

Blank=None (Standard)
CLXXX=Custom Lead Length (See Page 133)
G=Half Size Gull Wing (See Page 132)
G2=Half Size Gull Wing (See Page 132)

FREQUENCY

K=kHz, M=MHz

MECHANICAL DIMENSIONS ALL DIMENSIONS IN MILLIMETERS

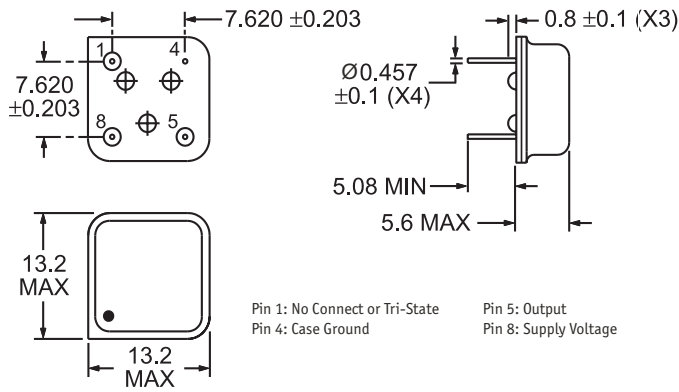

TAPE AND REEL DIMENSIONS ALL DIMENSIONS IN MILLIMETERS

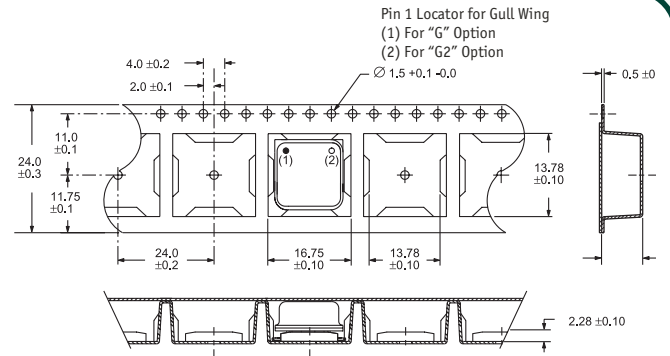

MARKING SPECIFICATIONS

Line 1: ECLIPTEK

Line 2: EC11 TS

Output Control Function
Blank = None (No Connection on Pin 1)
TS = Tri-State Enable High

Series Designator

Line 3: XX.XXX M

M=MHz, K=kHz

Frequency (5 Digits Maximum + Decimal)

Line 4: XX Y ZZ

Week of Year

Last Digit of Year

Ecliptek Manufacturing Identifier

Note: Pin 1 shall be designated with a dot

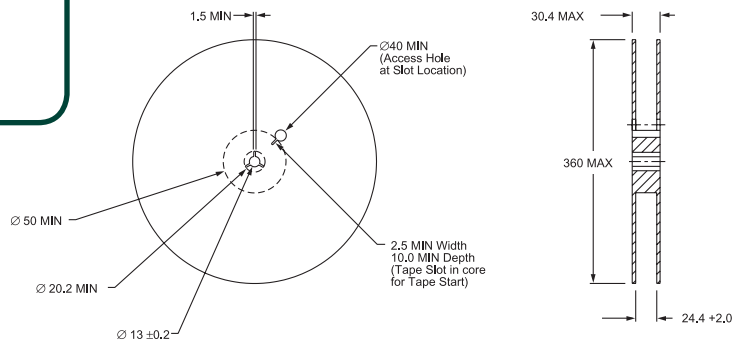

700 Pieces Per Reel
Compliant to EIA-481A

ENVIRONMENTAL/MECHANICAL SPECIFICATIONS

Characteristic	Specification
Fine Leak Test	MIL-STD-883, Method 1014, Condition A
Gross Leak Test	MIL-STD-883, Method 1014, Condition C
Mechanical Shock	MIL-STD-202, Method 213, Condition C
Vibration	MIL-STD-883, Method 2007, Condition A
Lead Integrity	MIL-STD-883, Method 2004
Solderability	MIL-STD-883, Method 2002
Temperature Cycling	MIL-STD-883, Method 1010
Resistance to Soldering Heat	MIL-STD-883, Method 210
Resistance to Solvents	MIL-STD-883, Method 215

MANUFACTURER	CATEGORY	SERIES	PACKAGE	VOLTAGE	CLASS	REV. DATE
ECLIPTEK CORP.	OSCILLATOR	EC11	8 pin DIP	5.0V	OS05	08/06