



# PG150~PG1510

## GLASS PASSIVATED JUNCTION PLASTIC RECTIFIER

**VOLTAGE** 50 to 1000 Volt **CURRENT** 1.5 Ampere

**DO-15** Unit: inch(mm)

### FEATURES

- Plastic package has Underwriters Laboratories Flammability Classification 94V-O utilizing Flame Retardant Epoxy Molding Compound.
- Exceeds environmental standards of MIL-S-19500/228
- Low leakage.
- Lead free in compliance with EU RoHS 2011/65/EU directive

### MECHANICAL DATA

- Case: Molded plastic, DO-15
- Terminals: Axial leads, solderable to MIL-STD-750, Method 2026
- Polarity: Color Band denotes cathode end
- Mounting Position: Any
- Weight: 0.014 ounce, 0.397 gram

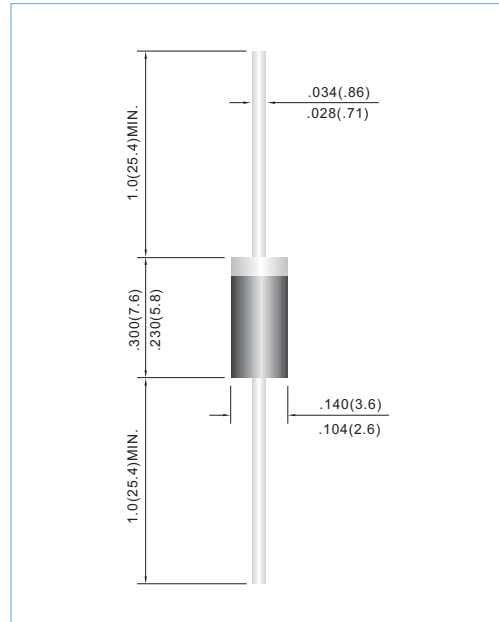

### MAXIMUM RATINGS AND ELECTRICAL CHARACTERISTICS

Ratings at 25°C ambient temperature unless otherwise specified. Resistive or inductive load, 60Hz, Single phase, half wave, For capacitive load, derate current by 20%

PARAMETER	SYMBOL	PG150	PG151	PG152	PG154	PG156	PG158	PG1510	UNITS
Maximum Recurrent Peak Reverse Voltage	$V_{RRM}$	50	100	200	400	600	800	1000	V
Maximum RMS Voltage	$V_{RMS}$	35	70	140	280	420	560	700	V
Maximum DC Blocking Voltage	$V_{DC}$	50	100	200	400	600	800	1000	V
Maximum Average Forward Current .375"(9.5mm) lead length at $T_A=60^\circ\text{C}$	$I_{F(AV)}$	1.5							A
Peak Forward Surge Current :8.3ms single half sine-wave superimposed on rated load(JEDEC method)	$I_{FSM}$	50							A
Maximum Forward Voltage at 1.5A	$V_F$	1.1							V
Maximum DC Reverse Current $T_J=25^\circ\text{C}$ at Rated DC Blocking Voltage $T_J=100^\circ\text{C}$	$I_R$	1.0 50.0							$\mu\text{A}$
Typical Junction capacitance (Note 1)	$C_J$	25							pF
Typical Thermal Resistance(Note 2)	$R_{\theta JA}$	45							$^\circ\text{C} / \text{W}$
Operating Junction and Storage Temperature Range	$T_J, T_{STG}$	-55 to +150							$^\circ\text{C}$

NOTES: 1. Measured at 1 MHz and applied reverse voltage of 4.0 VDC

2. Thermal resistance from junction to ambient and from junction to lead length 0.375"(9.5mm) P.C.B. mounted



# PG150~PG1510

## RATING AND CHARACTERISTIC CURVES

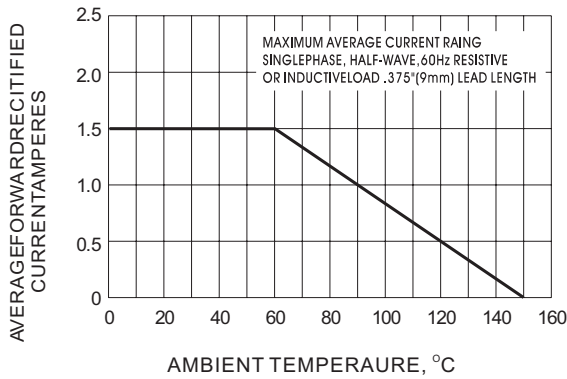

Fig.1- FORWARD CURRENT DERATING CURVE

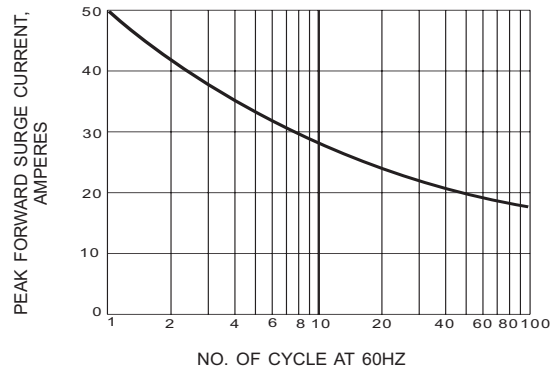

Fig.2- MAXIMUM OVERLOAD SURGE CURRENT

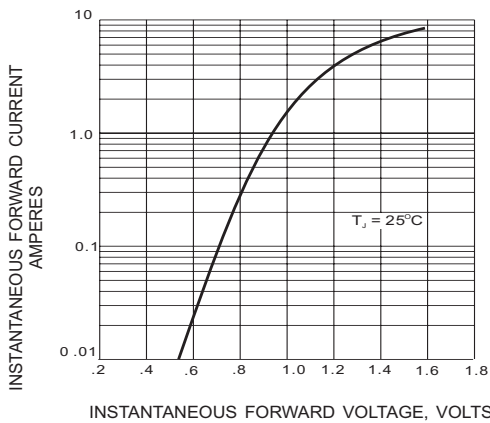

Fig.3- TYPICAL FORWARD CHARACTERISTIC

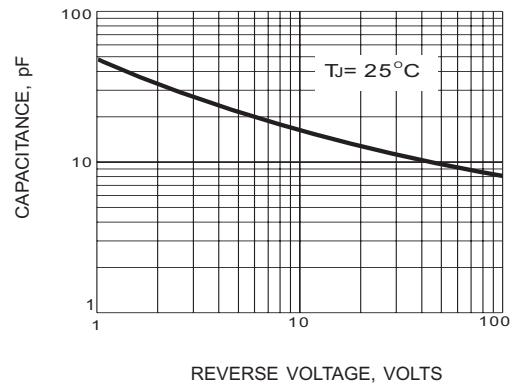

Fig.4- TYPICAL JUNCTION CAPACITANCE

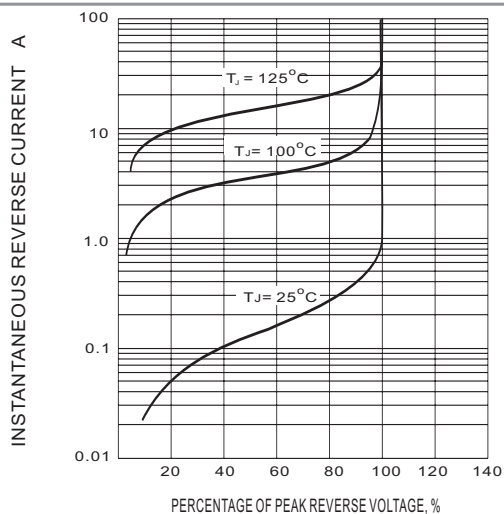

Fig.5- TYPICAL REVERSE CHARACTERISTIC



# PG150~PG1510

## Part No\_packing code\_Version

PG150\_AY\_00001  
 PG150\_AY\_10001  
 PG150\_B0\_00001  
 PG150\_B0\_10001  
 PG150\_R2\_00001  
 PG150\_R2\_10001

For example :

**RB500V-40\_R2\_00001**

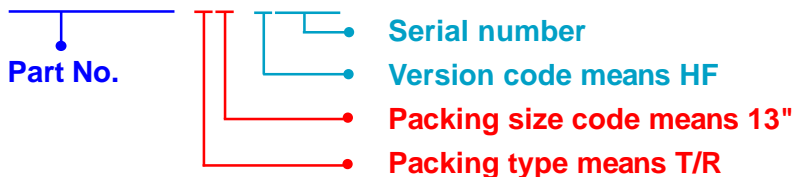

Packing Code <b>XX</b>				Version Code <b>XXXXX</b>		
Packing type	1 <sup>st</sup> Code	Packing size code	2 <sup>nd</sup> Code	HF or RoHS	1 <sup>st</sup> Code	2 <sup>nd</sup> ~5 <sup>th</sup> Code
Tape and Ammunition Box (T/B)	<b>A</b>	N/A	<b>0</b>	<b>HF</b>	<b>0</b>	serial number
Tape and Reel (T/R)	<b>R</b>	7"	<b>1</b>	<b>RoHS</b>	<b>1</b>	serial number
Bulk Packing (B/P)	<b>B</b>	13"	<b>2</b>			
Tube Packing (T/P)	<b>T</b>	26mm	<b>X</b>			
Tape and Reel (Right Oriented) (TRR)	<b>S</b>	52mm	<b>Y</b>			
Tape and Reel (Left Oriented) (TRL)	<b>L</b>	PANASERT T/B CATHODE UP (PBCU)	<b>U</b>			
FORMING	<b>F</b>	PANASERT T/B CATHODE DOWN (PBCD)	<b>D</b>			



## PG150~PG1510

---

### Disclaimer

- Reproducing and modifying information of the document is prohibited without permission from Panjit International Inc..
- Panjit International Inc. reserves the rights to make changes of the content herein the document anytime without notification. Please refer to our website for the latest document.
- Panjit International Inc. disclaims any and all liability arising out of the application or use of any product including damages incidentally and consequentially occurred.
- Panjit International Inc. does not assume any and all implied warranties, including warranties of fitness for particular purpose, non-infringement and merchantability.
- Applications shown on the herein document are examples of standard use and operation. Customers are responsible in comprehending the suitable use in particular applications. Panjit International Inc. makes no representation or warranty that such applications will be suitable for the specified use without further testing or modification.
- The products shown herein are not designed and authorized for equipments requiring high level of reliability or relating to human life and for any applications concerning life-saving or life-sustaining, such as medical instruments, transportation equipment, aerospace machinery et cetera. Customers using or selling these products for use in such applications do so at their own risk and agree to fully indemnify Panjit International Inc. for any damages resulting from such improper use or sale.
- Since Panjit uses lot number as the tracking base, please provide the lot number for tracking when complaining.

# Mouser Electronics

Authorized Distributor

Click to View Pricing, Inventory, Delivery & Lifecycle Information:

[Panjit:](#)

[PG152\\_R2\\_00001](#) [PG152\\_AY\\_00001](#) [PG152\\_B0\\_10001](#) [PG152\\_R2\\_10001](#) [PG152\\_B0\\_00001](#) [PG152\\_AY\\_10001](#)