

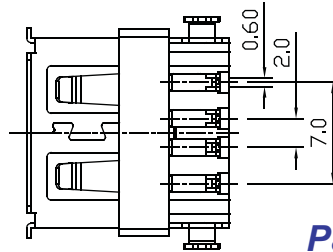

## USB Female Reverse Flat Dip 90° A Type

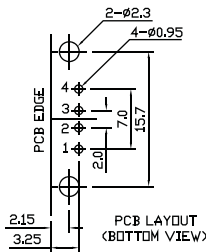
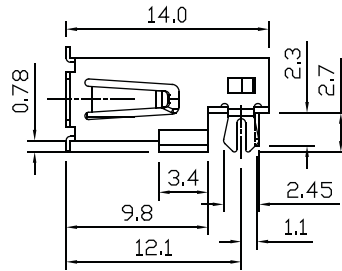
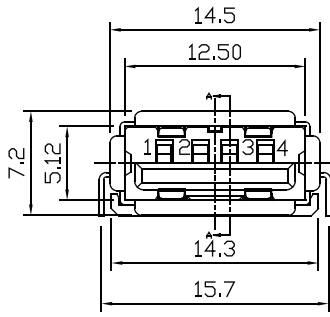

Part No.:USB-001RD-A1□-L

B:Black W:White

No.	Name	Material	Finish	Q'TY	Remark
1	Housing	PBT G.F.	Black/White	1	
2	Terminal	Phos. Bronze T=0.25	Gold/Tin Plated	4	Gold:1~3 μm; Ni:40~60 μm; Tin:120 μm (100% pure Tin of lead free plating)
3	Shell	Brass T=0.3	Nickel Plated	1	Ni:80~120u"

## USB Male Break SMT / Y Leg A Type

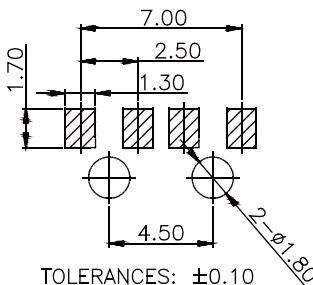
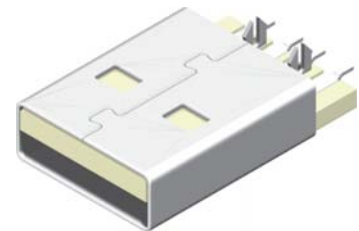
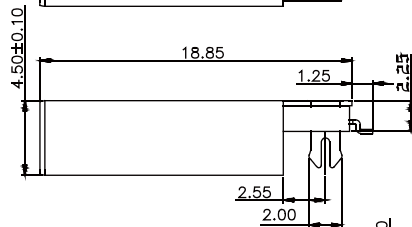
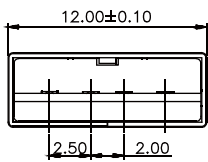
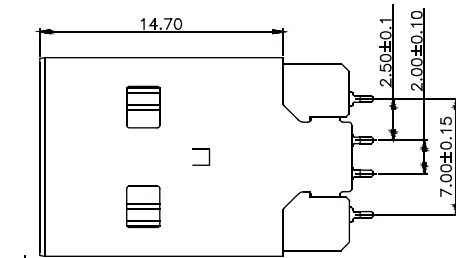

TOLERANCES: ±0.10  
RECOMMEND PCB LAYOUT

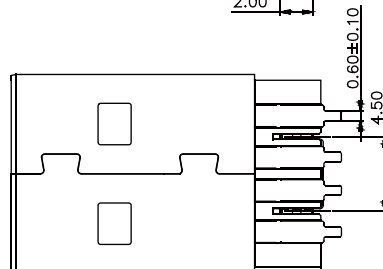

Part No.:USB-001Y-AW-U

W:White

No.	Name	Q'ty	Material	Remarks & Thickness	Finish
1	Housing	1	Nylon		White
2	Pin Term.	4	Copper Alloy	Ni:1~1.5u;Tin:3u. Gold:1~3u"	Gold/Tin Plated
3	Shell	1	Copper Alloy	Ni:2~3u	Nickel Plated

USB Conn. Series



ROHS