

FEATURES

- Transmit and Receive filters with half-channel compromise equalizers
- Call Progress Mode Answer/Originate mode switching
- Bell 212A, CCITT V.22 and V.22bis compatible with V.22 notch filters
- Analog Loopback capability

GENERAL DESCRIPTION

The SC11000, SC11001 and SC11005 modem filters are monolithic CMOS switched-capacitor filter circuits designed for use in full duplex 1200 and 2400 Bit Per Second modems. They meet the requirements of the Bell 212A, CCITT V.22 and V.22bis specifications and include high-band (2400 Hz) and low-band (1200 Hz) filters, half-channel compromise amplitude and group delay equalizers and smoothing filters for both bands. For CCITT V.22 and V.22bis applications, a notch filter is included that can be programmed for either 550 Hz or 1800 Hz. Also included in the filters are two uncommitted operational amplifiers that can be used for anti-aliasing filters or for gain control.

The SC11000 is pin and function compatible to the AMI S35212 and the Reticon R5632. Like the S35212, the high-band filter in the SC11000 can be scaled down by a factor of 6 so that it can be used to monitor call progress tones in an intelligent modem.

The SC11005 is pin and function compatible to the AMI S35212A. It contains all of the features of the SC11000, and like the S35212A, it contains an analog loopback mode—ALB (pin 14)—for testing the signal path.

The SC11001 is an enhanced version of the SC11005. In addition to all of the features of the SC11005, it

24-PIN DIP PACKAGE

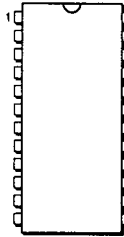

28-PIN PLCC PACKAGE

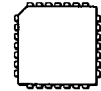

SC11001CV
SC11005CV

SC11000CN
SC11001CN
SC11005CN

contains two additional control pins, CPM (pin 12) and NFI (pin 13) that allow more accurate call progress monitoring and easier V.22 implementation without the need for external multiplexers or logic. Besides being able to scale the high-band filter by a factor of six, the low-band filter can be scaled by a factor of 2.5 for better centering over the call progress frequency range of 300 to 660 Hz. It also allows the unscaled high-band filter to be used for monitoring the modem answer tone, simplifying the design of full auto-dial/auto-answer modems.

SC11000/SC11001/SC11005 212A/V.22/V.22bis Modem Filters



BLOCK DIAGRAM

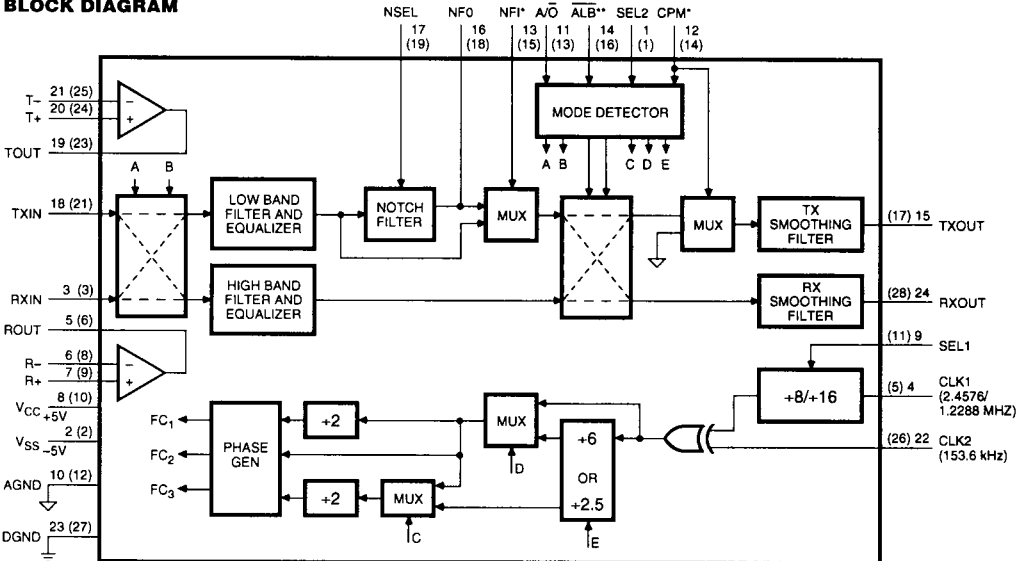

NOTES: NUMBERS NEXT TO SIGNAL NAMES ARE DIP PACKAGE PINS; NUMBERS IN () ARE PLCC PINS. PLCC PINS (4), (7), (20), & (22) ARE NOT CONNECTED.

PINS 1, 4, 11, 12*, 13*, 17 AND 22 HAVE INTERNAL PULL-DOWN REGISTERS TO GROUND. PIN 14 HAS AN INTERNAL PULL-UP TO V_{CC}.

* FOR SC11001. PINS NOT CONNECTED ON SC11000 AND SC11005.

** FOR SC11001 AND SC11005. PINS NOT CONNECTED ON SC11000.

PIN DESCRIPTIONS

PIN NO.	PIN NAME	DESCRIPTION
1 (1)	SEL2	Call progress mode selection; SEL2 low for normal operation, SEL2 High scales down the high-band, filter by 6 for call progress monitoring
2 (2)	V _{SS}	Negative supply
3 (3)	RXin	Receive signal input
4 (5)	CLK1	Clock input 1; 2.4576 MHz with SEL1 high, or 1.2288 MHz with SEL1 low
5 (6)	Rout	Output of the R amplifier
6 (8)	R-	Inverting input to the R amplifier
7 (9)	R+	Noninverting input to the R amplifier
8 (10)	V _{CC}	Positive supply
9 (11)	SEL1	Selects clock frequency into pin 4; low for 1.2288 MHz, high for 2.4576 MHz
10 (12)	AGND	Analog ground
11 (13)	A/ \bar{O}	Answer/originate mode selection; high for answer, low for originate
12 (14)	CPM	Enhanced call progress mode selection; CPM low for normal operation; CPM high scales down the low-band filter by 2.5 for enhanced call progress monitoring
13 (15)	NFI	Notch filter insert; low for notch filter bypass, high for inserting
14 (16)	\bar{ALB}	Analog loopback; high for normal operation, low to loopback TXin to RXout
15 (17)	TXout	Transmit signal output
16 (18)	NFO	Notch filter output
17 (19)	NSEL	Notch filter selection; low for 550 Hz, high for 1800 Hz
18 (21)	TXin	Transmit signal input
19 (23)	Tout	Output of the T amplifier
20 (24)	T+	Noninverting input to the T amplifier
21 (25)	T-	Inverting input to the T amplifier
22 (26)	CLK2	Clock input 2; 153.6 kHz
23 (27)	DGND	Digital ground
24 (28)	RXout	Receive signal output

Note: Pin numbers in () refer to 28-lead PLCC pinout.

FUNCTIONAL DESCRIPTION

Low-Band Filter

The low-band filter is a 10th order switched-capacitor band-pass filter with a center frequency of 1200 Hz. See Figure 3 for the amplitude response of this filter. In the originate mode this filter is used in the transmit direction; in the answer mode it is used in the receive direction. When analog loopback is used in the originate mode, this filter, together with the low-band delay equalizer, will be in the test loop. In the Call Progress Monitoring mode with SEL2 (pin 1) high and CPM (pin 12) low, the center frequency of this filter is shifted down by a factor of 6 to 200 Hz. If pin 12 (CPM) is high, then the filter response will be scaled down by 2.5, moving the center frequency to 480 Hz.

Low-Band Delay Equalizer

The low-band delay equalizer is a 10th order switched-capacitor all-pass filter that compensates for the group delay variation of the low-band filter and half of the compromise line characteristics, producing a flat delay response within the pass-band. See Figure 4 for the group delay response of the low-band filter cascaded with the low-band delay equalizer.

High-Band Filter

The high-band filter is a 10th order switched-capacitor band-pass filter with a center frequency of 2400 Hz. See Figure 5 for the amplitude response of this filter. In the answer mode, this filter is used in the transmit direction; in the originate mode, it is used in the receive direction. When analog loopback is used in the answer mode, this filter, together with the high-band delay equalizer, will be in the test loop. In the Call Progress Monitoring mode, with SEL2 (pin 1) high and CPM (pin 12) low, the center frequency will be shifted down by a factor of 6 to 400 Hz. If pin 1 is low or pin 12 is high, this filter operates in the normal data mode.

High-Band Delay Equalizer

The high-band delay equalizer is a 10th order switched-capacitor all-pass filter that compensates for the group delay variation of the high-band filter and half of the compromise line characteristics, producing a flat delay response within the pass-band. See Figure 6 for the group delay response of the high-band filter cascaded with the high-band delay equalizer.

Transmit Smoothing Filter

The transmit smoothing filter is a first order low-pass switched-capacitor filter.

Receive Smoothing Filter

The Receive Smoothing Filter consists of a 2nd order low-pass switched-capacitor filter cascaded with a 2nd order, active RC, low-pass filter.

V.22 Notch Filter

The V.22 Notch Filter is a 2nd order switched-capacitor notch filter. The center frequency of the filter is at 550 Hz when NSEL (pin 17) is low and is shifted to 1800 Hz when NSEL is high. This filter is bypassed in the low-band if NFI (pin 13) is low. Its output, however, will always be available at pin 16 (NFO).

Uncommitted Operational Amplifiers

Two operational amplifiers—called the R amplifier and the T amplifier—are included as part of the SC11001 and SC11005. They are not used by the filter circuit and can be used, for example, as anti-aliasing filters or gain stages in a complete 212A modem circuit.

Analog Loop-Back

When $\overline{\text{ALB}}$ (pin 14) is low, the signal transmitted by the modem, TXin, is looped back to the modem through the RXout pin. If the low (high)-band filter/equalizer is to be

tested, the $\overline{\text{A/O}}$ pin should be low (high). The receive smoothing filter is in this loop regardless of the $\overline{\text{A/O}}$ level. An internal pull up resistor keeps this pin high when it is not connected externally.

Answer/Originate Mode Selection

When $\overline{\text{A/O}}$ (pin 11) is low, the modem operates in the originate mode, transmitting in the low-band and receiving in the high-band. If $\overline{\text{A/O}}$ is high, the modem operates in the answer mode, transmitting in the high-band and receiving in the low-band. An internal pull down resistor keeps this pin low when it is not connected externally.

Clock Selection

SEL1 (pin 9) is used to select the correct internal divider, depending on the frequency of the external clock. SEL1 is set high for use with a 2.4576 MHz clock input on CLK1 (pin 4), and set low for a 1.2288 MHz input on CLK1 (pin 4). If a 153.6 kHz clock is used on CLK2 (pin 22), CLK1 (pin 4) and SEL1 (pin 9) should be left open.

Normal/Call Progress Mode

When SEL2 (pin 1) and CPM (pin 12) are low, the filter operates in the normal data mode—the modem mode. When either pin is high, the filter operates in the Call Progress Monitoring mode. When SEL2 is high and CPM is low, the center frequencies of both the low-band and the high-band filters are shifted down to one sixth of the frequencies used in the normal data mode. SEL2 is internally pulled down to keep it at a low level when it is not connected externally.

When CPM is high, the low-band filter is scaled down by a factor of 2.5 (Figure 7) and RXout is either the output of the scaled low-band filter, or the unscaled high-band filter, depending on the logic levels at $\overline{\text{ALB}}$ (pin 14) and $\overline{\text{A/O}}$ (pin 11) as shown in Table 1.

Transmit Squelch in Call Progress Mode

When CPM is high—Call Progress Mode—the input of the transmit smoothing filter is disconnected and shorted to ground, squelching the transmitter. In the handshake sequence of a 212A modem, this feature can be used to eliminate any

transmit signal output. An internal pull down resistor keeps the CPM pin low when it is not connected externally.

SEL2 (pin 1), CPM (pin 12), ALB (pin 14), and A/O (pin 11) control the modes of operation of the filter as shown in Table 1. For each combination of these pins, the table

shows to which filter each input or output is connected. "L" refers to the low-band filter with the response shown in Figure 2. "H" is used to denote the high-band filter as characterized in Figure 2. When L or H are divided by a factor (6 or 2.5), this is indicated as L/6, H/6, etc., meaning the frequency response is scaled down by 6.

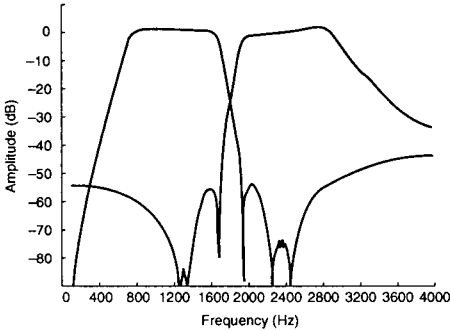

Figure 2. Low-Ban and High-Band Amplitude Response—Normalized

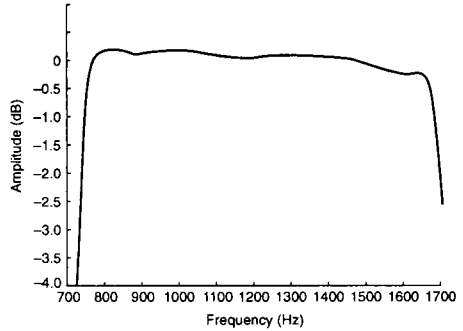

Figure 3. Low-Band Response—Normalized

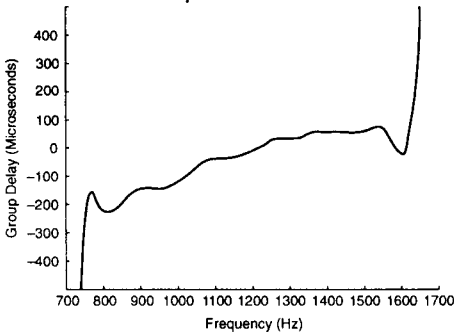

Figure 4. Low-Band Group Delay

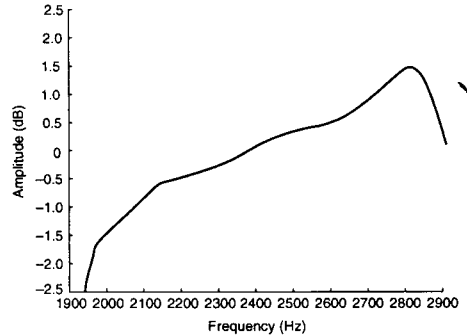

Figure 5. High-Band Response—Normalized

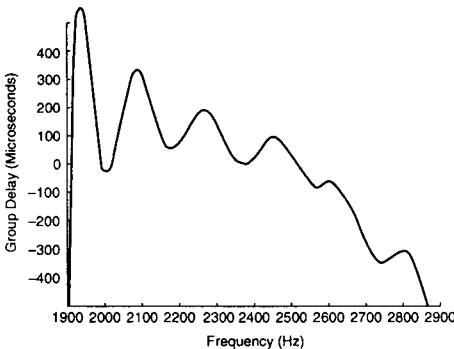

Figure 6. High-Band Group Delay (Hz)

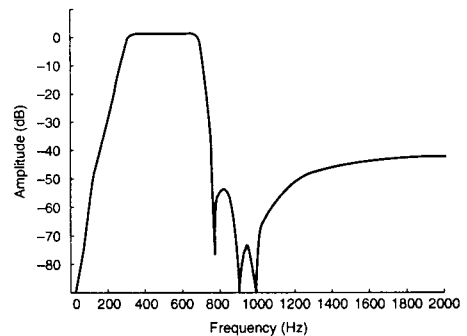

Figure 7. Low-Band Divided by 2.5 Amplitude Response—Normalized

Mode	CPM	SEL2	$\overline{\text{ALB}}$	$\overline{\text{A/O}}$	TXin	TXout	RXin	RXout
0	0	0	1	0	L	L	H	H
1	0	0	1	1	H	H	L	L
2	0	0	0	0	L	L	H	L
3	0	0	0	1	H	H	L	H
4	0	1	1	0	L/6	L/6	H/6	H/6
5	0	1	1	1	H/6	H/6	L/6	L/6
6	0	1	0	0	L/6	L/6	H/6	L/6
7	0	1	0	1	H/6	H/6	L/6	H/6
8	1	X	1	0	—	SQT	(L/2.5 + H)	H
9	1	X	1	1	H	SQT	L/2.5	L/2.5
10	1	X	0	0	—	SQT	(L/2.5 + H)	L/2.5
11	1	X	0	1	H	SQT	L/2.5	H

Note: SQT means the transmitter output is squelched.

"L" refers to center frequency of 1200 Hz.

"H" refers to center frequency of 2400 Hz.

— means no filter connection

+ means connection to both filters

X means "don't care"

By switching between modes 8 and 10, the filter can be used to detect reception of the call progress tones in the L/2.5 band as well as the answer tone in the H band.

Table 1. Operating Modes

ABSOLUTE MAXIMUM RATINGS (Note 1)

Supply Voltage, V_{CC}	7 V
Supply Voltage, V_{SS}	-7 V
Input Voltage-Analog Signals (Pins 3, 6, 7, 18, 20, 21)	$V_{CC} + 0.6$ V $V_{SS} - 0.6$ V
Input Voltage-Digital Signals (Pins 1, 4, 9, 11, 12, 13, 14, 17, 22)	$V_{CC} + 0.6$ V $V_{SS} - 0.6$ V
Storage Temperature Range	-65 to +150°C
Maximum Power Dissipation @ 25°C (Note 2)	500 mW
Lead Temperature (Soldering, 10 sec)	300°C
Operating Temperature Range (Plastic)	0 to +70°C

Note 1. "Absolute Maximum Ratings" are those values beyond which the safety of the device cannot be guaranteed. Except for "Operating Temperature Range", the device should not be operated at these limits. The table of "Electrical Characteristics" provides actual operating limits.

2. Power dissipation temperature derating—plastic "N" package: -12 mW/°C from 65°C to 85°C.

DC ELECTRICAL CHARACTERISTICS**T_A = 0°C to 70°C, V_{CC} = +5 V ±10%, V_{SS} = -5 V ±10%**

PARAM.	DESCRIPTION	CONDITIONS	MIN	TYP	MAX	UNITS
V _{CC}	Positive Supply Voltage		4.5	5.0	5.5	V
V _{SS}	Negative Supply Voltage		-4.5	-5.0	-5.5	V
I _{CC}	Quiescent Current	No Load		7.5	15	mA
I _{SS}	Quiescent Current	No Load		7.5	15	mA
V _{IH}	High Level Input Voltage; Digital Signal Pins 1, 4, 9, 11, 12, 13, 14, 17, 22		2.0			V
V _{IL}	Low Level Input Voltage; Digital Signal Pins 1, 4, 9, 11, 12, 13, 14, 17, 22				0.8	V
V _{OMAX}	Output Signals, Pins 5, 15, 16, 19, 24	V _{CC} = +5 V, V _{SS} = -5 V R _L = 10 kΩ (Pins 5, 19) R _L = 20 kΩ (Pins 15, 16, 24)	±3			V

PERFORMANCE CHARACTERISTICS**T_A = 25°C, V_{CC} = +5 V, V_{SS} = -5 V**

PARAMETER	CONDITIONS	MIN	TYP	MAX	UNITS
Output Noise RXout, TXout			30	33	dBrnCo
Crosstalk		55	60		dB
Total Harmonic Distortion			0.3		%
Dynamic Range			70		dB
Adjacent Channel Rejection Low band High band		55 55	65 75		dB dB
Passband Gain at Center Frequency (1200 Hz, 2400 Hz)		-1		+1	dB
Relative Gain—Low Band Reference = 1200 Hz	@ 400 Hz @ 800 Hz @ 1600 Hz @ 1800 Hz @ 2000 Hz @ 2400 Hz @ 2800 Hz	-1 -1.5		-35 +1 +1 -18 -48 -55 -50	dB dB dB dB dB dB dB
Relative Gain—High Band Reference = 2400 Hz	@ 800 Hz @ 1200 Hz @ 1600 Hz @ 2000 Hz @ 2800 Hz @ 3200 Hz @ 3500 Hz	-2.5 0		-50 -53 -50 +0.5 +2.5 -10 -20	dB dB dB dB dB dB dB
Relative Gain—Low Band NFI = High	@ 550 Hz, NSEL = Low @ 1800 Hz, NSEL = High			-40 -40	dB dB

APPLICATIONS

Modes of Operation

The SC11000, SC11001 and SC11005 filters can be operated in three basic modes—a normal data mode, a test mode and a call progress monitor mode.

Normal Data Mode

Figures 8 through 11 illustrate the signal flow diagrams for the filter in the normal data mode for either a 212A or a V.22 modem. In the originate mode, the transmit signal goes through the low-band filter and the receive signal goes through the high-band filter. In the answer mode, the transmit signal goes through the high-band filter and the receive signal goes through the low-band filter.

Test Mode

The filter can be tested by entering the analog loopback mode as illustrated in Figures 12 and 13. In this mode, the transmit signal is looped back to the RXout pin after going through either the low-band filter or the high-band filter, depending on originate or answer mode selec-

tion. The analog loopback mode facilitates testing of the modem locally, without having to make a data call.

Call Progress Monitor Mode

The filter operates in one of two different call progress monitor modes, depending on whether the SEL2 or CPM pin is taken high. If SEL2 is taken high, the center frequency of both the low-band and high-band filters is shifted down by a factor of 6 and the bandwidth of the filters is also reduced by a factor of 6. Thus the high-band filter is shifted down to 400 Hz \pm 80 Hz while the low-band filter is shifted down to 200 Hz \pm 80 Hz. By selecting the originate mode, the receive signal will go through the modified high-band filter which now has a pass-band of approximately 300 Hz to 480 Hz. This allows precision dial tone of 350/440 Hz as well as audible ringing tone of 440/480 Hz to pass. However, only a portion of the busy or reorder tone of 480/620 Hz will pass through. An external energy detector circuit, combined with a method of cadence and timing determination, distinguishes between different conditions on the

line during establishing a call.

The SC11001 features an additional mode for monitoring the call progress tones. This mode is initiated by taking the CPM pin high. Two deficiencies, inherent in the first mode described above, are overcome in this enhanced mode. First, the pass-band is more accurately centered over the call progress tone frequencies because the low-band filter is scaled down by a factor of 2.5. The low-band filter thus has a pass-band of 290 Hz to 670 Hz which allows the busy tone to pass through completely. Secondly, since the high-band filter is not scaled, answer tone can be easily monitored. The receive signal is connected to both the high-band filter and the scaled low-band filter. By toggling the ALB pin between high and low levels, either the answer tone or the call progress tone can be monitored on the RXout pin.

Figures 14 and 15 show the signal flow diagrams in the call progress monitor mode. A method for determining conditions on the line during establishing a call is described in the following section.

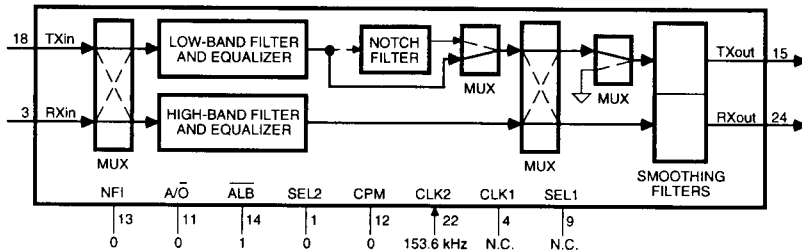

Figure 8. 212A Originate Mode

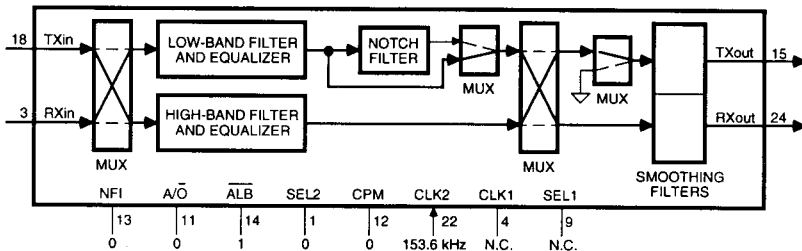

Figure 9. 212A Answer Mode

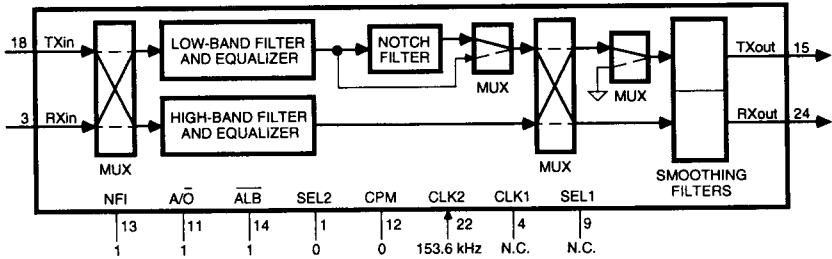

Figure 10. V.22 Answer Mode

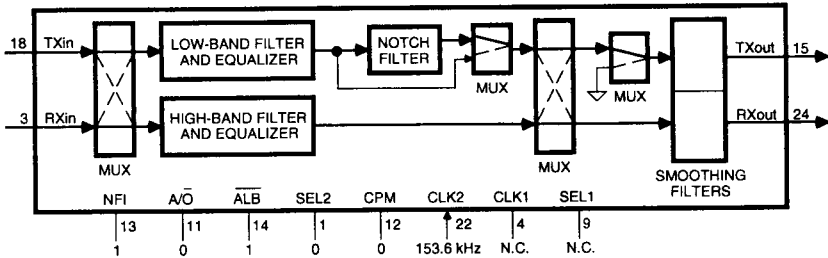

Figure 11. V.22 Originate Mode

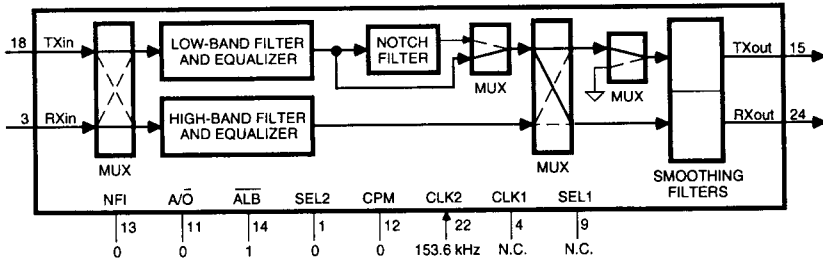

Figure 12. 212A Analog Loopback Mode Using Low-Band Filter (Originate Mode)

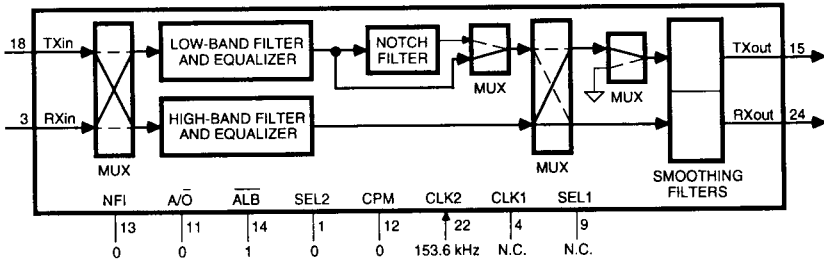

Figure 13. 212A Analog Loopback Mode Using High-Band Filter (Answer Mode)

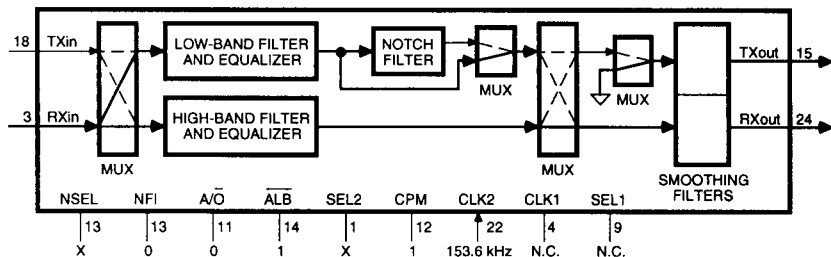

Figure 14. Call Progress Monitor Mode: Monitoring Answer Tone/Voice

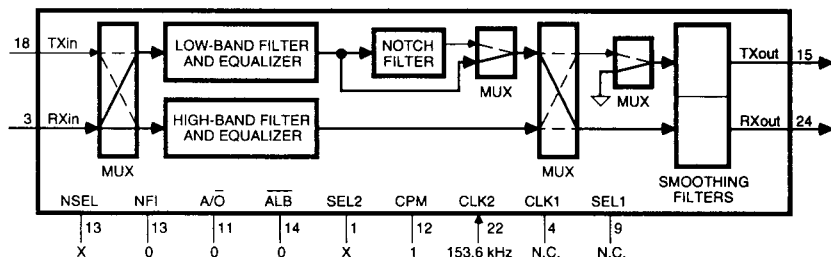

Figure 15. Call Progress Monitor Mode: Monitoring Call Progress Tones

Circuit Description

In the circuit of Figure 16, op amps U_1 and U_2 and resistors R_8 thru R_{13} form a 2 to 4 wire converter that separates the line signal into the transmit and receive components. The receive signal is connected to the RXin input of the SC11001 filter. In the call originate mode, it goes through the high-band filter and comes out on the RXout pin. For call progress monitoring the low-band filter operates in the scaled mode, thus filtering the receive signal over the range of 290 Hz to 670 Hz. Op amps U_3 and U_4 , comparator U_5 and associated discrete components form the energy detector. U_3 operates as a full wave rectifier. U_4 is a buffer that drives a low pass filter formed by R_{18} and C_4 . The filtered signal is compared to a level set by R_{19} and R_{20} . The output of U_5 goes high if the signal level exceeds the level set by R_{19} and R_{20} . This output corresponds to the cadence infor-

mation in the call progress tone signals and can be sampled by the controller according to the detection algorithm.

The rest of the circuitry in Figure 16 performs the functions of the DAA. Transformer T_1 provides isolation and sinks the line current in the off hook state. R_1 , R_2 , V_1 , Z_3 and Z_4 provide surge protection. Relay KR_1 and transistor Q_1 control on hook/off hook condition. C_1 , R_3 , Z_1 , Z_2 , D_1 and OC_1 's internal diode limit and rectify the high voltage AC ringing signal. OC_1 provides isolation. R_4 and C_2 filter the rectified ring signal and Schmidt Trigger IC. U_6 converts it into a logic level for the controller.

A Call Progress Monitoring Application

Figure 16 shows a schematic for using the SC11001 filter in a call progress monitoring application.

Specifically, this arrangement is well suited for implementing an intelligent 212A or V.22 modem. The modem can be designed to be either stand-alone with RS-232 interface to DTE or integrated in a computer with a parallel bus interface. It is assumed that a controller is available that can control the various operating modes of the filter, monitor the output of the energy detector and ring indicator, and control the switch-hook relay in the Data Access Arrangement (DAA). This application illustrates how the modem filter can be used with minimum of external circuitry to implement a fully automatic call establishment procedure.

Table 2 summarizes various call progress tone frequencies and their cadences. A call progress monitoring algorithm based on timing and cadence characteristics is described in the flow chart of Figure 17.

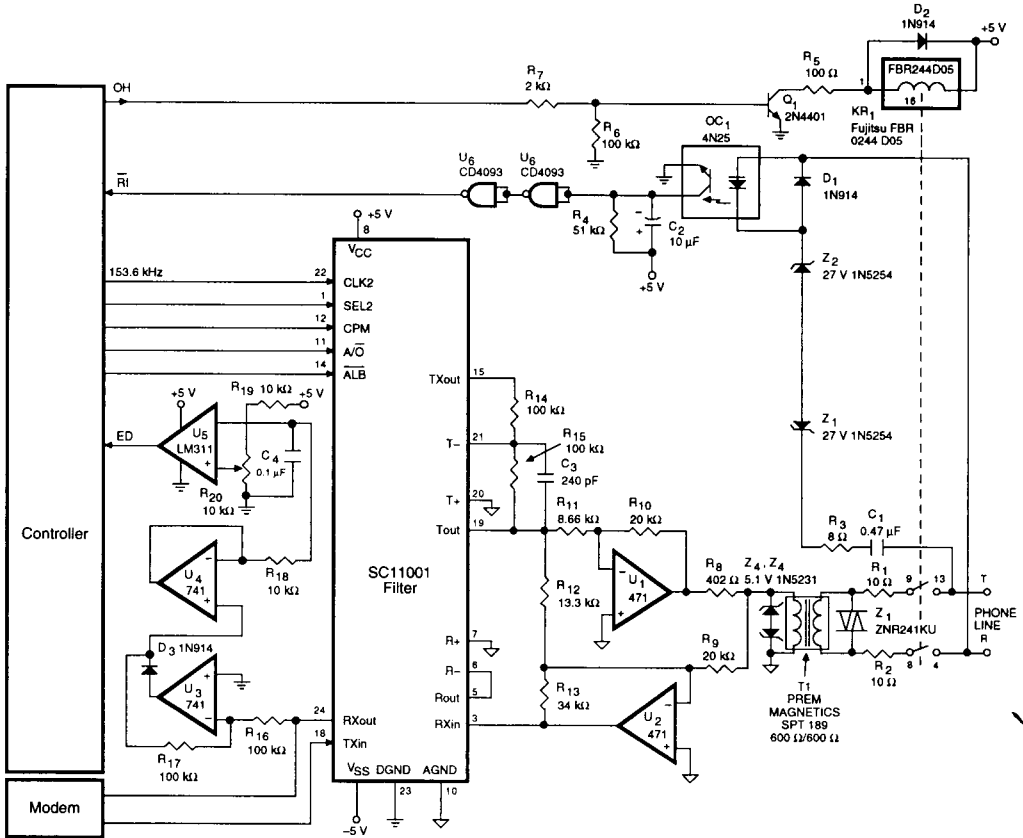

Figure 16. A Call Progress Monitoring Application

Call Progress Tone	Frequency (Hz)	Cadence
Dial tone	350 + 440* 400, 425 600 x 120 IPS**	Continuous steady tone
Audible ring	440 + 480* 400, 450 420 x 40 IPS 400 x 25 IPS	2 s on/4 s off 1 s on/3 s off
Busy (station)	480 + 620* 400, 425, 450 600 x 120 IPS	0.5 s on/0.5 s off
Busy (circuit)	Same as above	0.25 s on/0.25 s off
Off hook alert	Multifrequency	1 s on/1 s off

*Precision tone specified by AT&T

**IPS means interruptions per second

Table 2. Call Progress Tone Characteristics

Detection Algorithm

Figure 17 shows the flowchart of a detection algorithm that utilizes the features provided in the SC11001 filter and that uses the cadence information contained in the call progress tones to determine the status of the line. The main criterion in this algorithm was the high degree of reliability it provides, rather than the speed in which it executes. For instance, dial tone is detected only when the output of the energy

detector is continuously high for at least one second. If dial tone is not detected within 5 seconds of going off hook, the call is aborted. Many dialers do not wait for the initial dial tone and begin dialing as soon as going off hook. This is termed blind dialing and is avoided by this algorithm.

Once dial-tone is detected, the first digit is dialed using the tone mode. Provision is made to check the absence of the dial-tone after the digit

is dialed. If dial-tone remains on the line, the controller can either hang up the line or try to dial using rotary pulse dialing. If dial-tone is absent, the rest of the digits can be pulse dialed.

The algorithm waits for 1 second after dialing is done to monitor the energy detector. This insures that any clicks on the line will not cause a false detection. The ALB pin of the filter is then toggled at a 100 ms rate and the energy detector output is

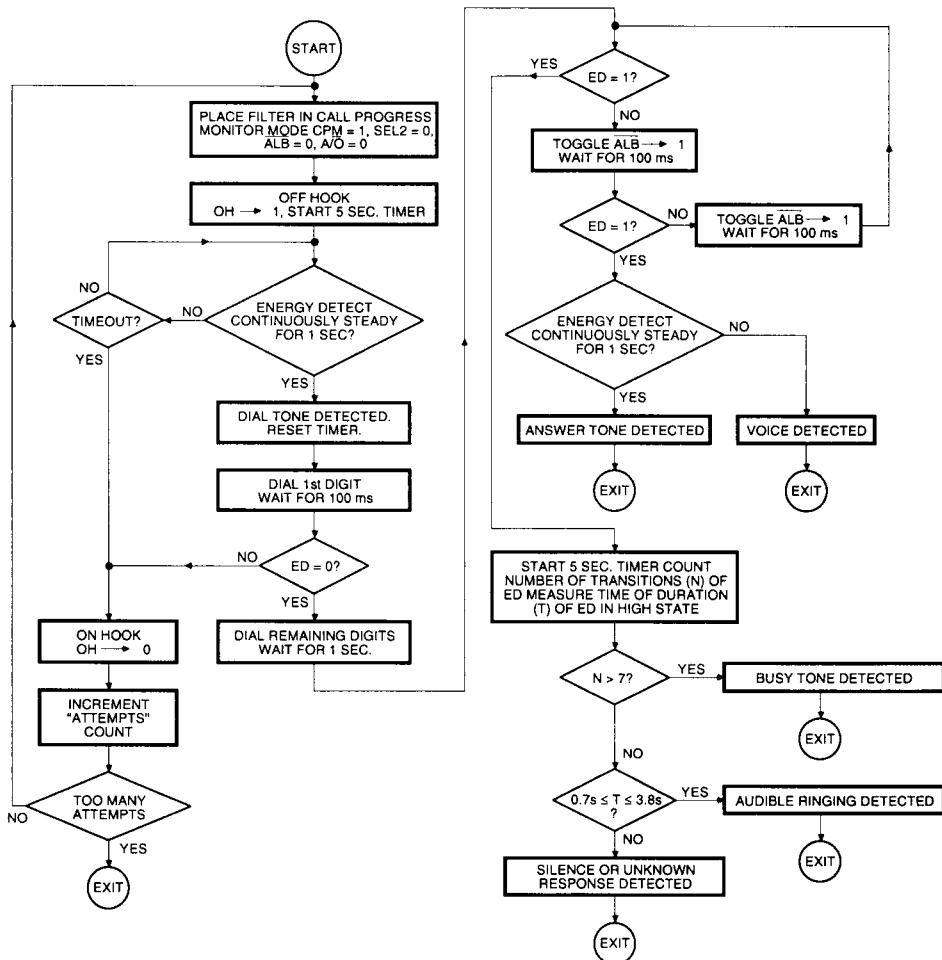

Figure 17. Call Progress Monitoring Algorithm



sampled to see if there is energy in the call progress band or in the voice band. If energy is detected in the call progress band, a 5 second timer is started and the number of transitions of the ED output are counted (N). The cumulative duration in which the ED output is in the high state is also measured (T).

The algorithm makes a determination of various conditions based on N and T. The line is determined to be busy if N exceeds 7. If N is less than 7 and T is in the range of 0.7

seconds to 3.8 seconds, the signal is determined to be audible ringing. The controller can then count the ring cycles or start a timer. It can choose to hang up if the timer overflows or if the number of ring cycles exceeds a preset value. Any other value of N or T is classified as unknown response and it is left to the controller to take the next action.

If energy is detected in the high band, ED output is monitored to see if it is continuously high for at least one second. If so, this is interpreted

as the distant modem answer tone, indicating that the connection is made. If not, it indicates either silence or voice. In either case the controller can terminate the call and take the next step. Minor variations of this algorithm or fine tuning of the decision values can provide the designer with the flexibility he needs to deal with different situations. It should be emphasized that the algorithm does not stand alone and must be integrated in the application software for satisfactory performance.