

MODEL 830-004

Power Supply Module

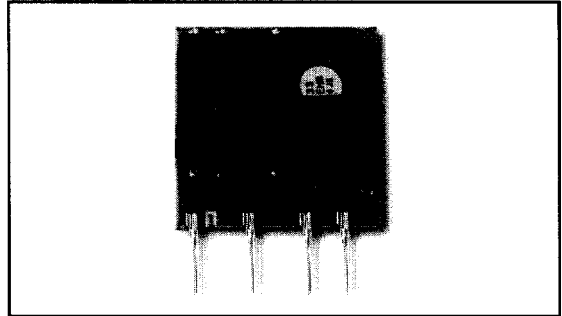

DESCRIPTION

The 830-004 is a single output isolated DC/DC converter with an input range of 110 to 375 Vdc. This allows the module to operate from any rectified 80 to 265 Vac line, corresponding to line voltages found worldwide. Different fixed output voltages between 5

to 18 Vdc are available to suit a variety of applications. Low cost, high reliability and small dimensions are the main characteristics of this design. The use of an advanced PWM provides for stable and efficient operation over a wide load range.

FEATURES

- Continuous 6 watts of output power without use of a heat sink
- Wide input voltage range from 110 Vdc to 375 Vdc
- Single fixed regulated output, voltages available from 5 Vdc to 18 Vdc
- Full isolation (2,500 V) from input to output
- Sustains continuous short circuit
- Two sided layout design and SIP package minimized board space requirement
- Efficient circuit design constructed on a thermally conductive ceramic substrate

APPLICATIONS

- Provides DC power for PWM and control circuitry for off-line switching power suppliers
- Provides isolated low DC voltages from AC line voltage levels (rectifier external)
- Stand-alone power supply for small electronics and μ P controlled appliances
- Replacement for wall mount transformers and linear regulators

Specifications subject to change without notice.

TYPICAL CONFIGURATION

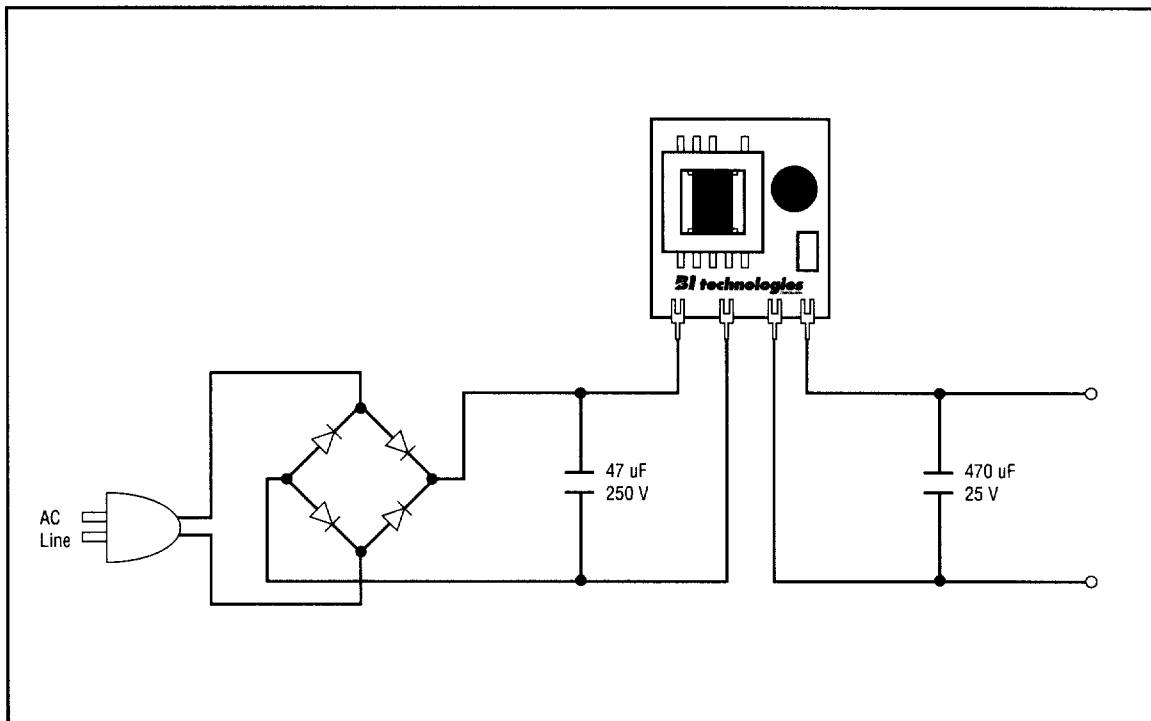

APPLICATION NOTES

Model 830-004 is a complete DC/DC module based on a flyback circuit topology.

Most applications require the addition of output capacitance.

The capacitor's voltage rating should be selected in correlation to the output voltage of the 830-004. Choose sufficient capacitance to reduce the output ripple to an acceptable level for the application.

A 470 µF electrolytic should generally be suitable. Locate close to the output pins.

To operate from an AC line, a bridge rectifier must be added.

A DB104 bridge rectifier or four IN4005 configured as pictured.

Diodes should be 600 volts, 1 amp and should be used in conjunction with a 47 µF input capacitor.

Choose the voltage rating appropriately.

For example, 117 Vac generates 165 volts peak. At a 1.5 x derating, use a 250 volt capacitor.

ELECTRICAL

| PARAMETER | CONDITIONS | MIN. | TYP. | MAX. | UNITS |
|-----------------------|--|------|------|------|------------------|
| Input Voltage | | 110 | | 375 | Vdc |
| Output Voltage, Nom.* | 50% Rated Output Power | -5% | * | +5% | Vdc |
| Load Regulation | 20%-80% Rated Output Power | -8% | | +8% | % chg. from Nom. |
| Line Regulation | Vin min. to max. 50% Rated Output Power | | | 50 | Δ mV |
| Output Ripple | See Typical Configuration | | | 250 | mVpp |
| Efficiency | 20% Rated Power | | 55 | | % |
| | 50% Rated Power | | 70 | | % |
| | 100% Rated Power | | 75 | | % |
| Operating Frequency | | | 500 | | KHz |
| Output Power | | | | 6 | W |
| Operating Temperature | | 0 | | 70 | $^{\circ}$ C |

* Standards available in 1 volt increments from 5 V to 18 V. Order as 830-004-VXX.
Nonstandard voltages available upon request.

ELECTRICAL CURVES

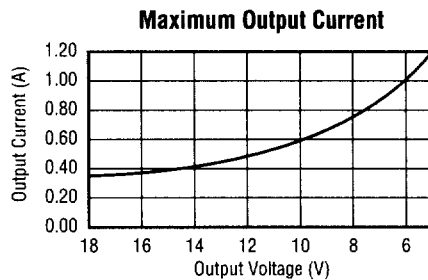
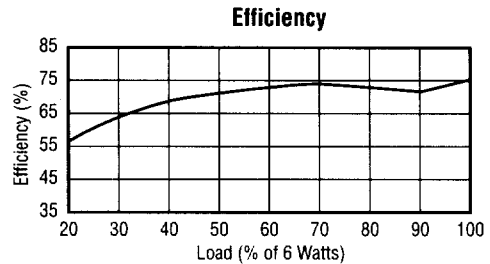
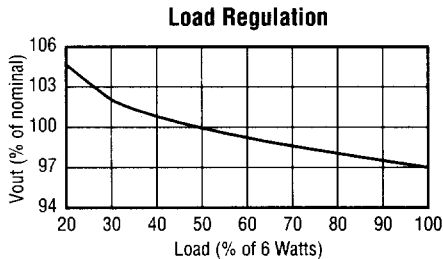

OUTLINE DIMENSIONS (Inch)

Vertical Mounting, Through-Hole, SIP

This module is produced in a 4 lead SIP package to achieve a maximum reduction of required board space.

Leads:
 1: Vin+ 3: Vout-
 2: Vin- 4: Vout+

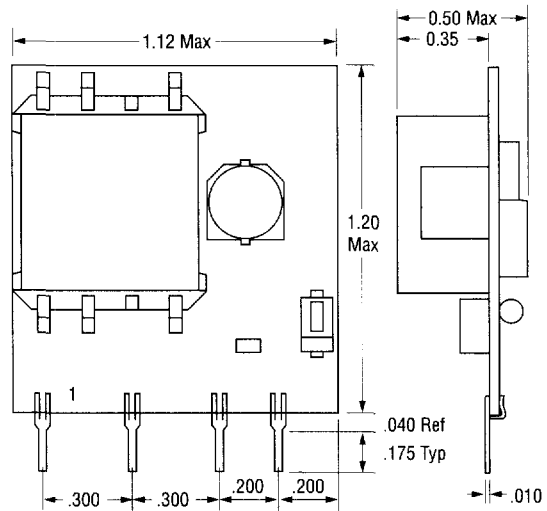

Horizontal Mounting, Through-Hole, SIP

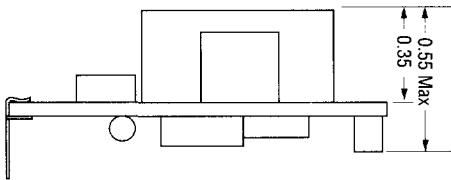

Horizontal Mounting, Surface Mount, SIP

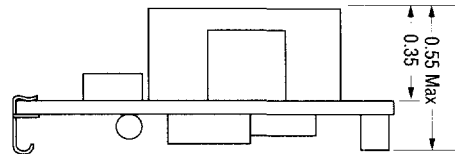

ORDERING INFORMATION

