

The RF Line UHF Power Amplifiers

Capable of wide power range control as encountered in portable cellular radio applications (30 dB typical).

- MHW803-2 806-870 MHz
- Specified 7.5 Volt Characteristics
 - RF Input Power = 1 mW (0 dBm)
 - RF Output Power = 2 Watts
 - Minimum Gain ($V_{Control} = 4 V$) = 33 dB
 - Harmonics = -45 dBc Max @ $2 f_o$
- 50 Ω Input/Output Impedance
- Guaranteed Stability and Ruggedness
- Epoxy Glass PCB Construction Gives Consistent Performance and Reliability
- Circuit board photomaster available upon request by contacting RF Tactical Marketing in Phoenix, AZ.

MHW803-2

**2 W, 806 to 905 MHz
UHF POWER
AMPLIFIERS**

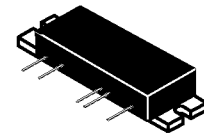

CASE 301E-04, STYLE 1

MAXIMUM RATINGS (Flange Temperature = 25°C)

Rating	Symbol	Value	Unit
DC Supply Voltage (Pins 2,3,4)	$V_{s1,2,3}$	10	Vdc
DC Control Voltage (Pin 1)	V_{Cont}	4	Vdc
RF Input Power	P_{in}	3	mW
RF Output Power ($V_{s1} = V_{s2} = V_{s3} = 10 V$)	P_{out}	3	W
Operating Case Temperature Range	T_C	-30 to +100	°C
Storage Temperature Range	T_{stg}	-30 to +100	°C

ELECTRICAL CHARACTERISTICS $V_{s1} = V_{s2} = V_{s3} = 7.5 Vdc$, (Pins 2,3,4), $T_C = 25^\circ C$, 50 Ω System

Characteristic	Symbol	Min	Max	Unit
Frequency Range	—	806	870	MHz
Control Voltage ($P_{out} = 2 W$, $P_{in} = 1 mW$) (1)	V_{Cont}	0	4	Vdc
Quiescent Current (V_{s1} , Pin 2 = 7.5 Vdc) (2)	$I_{s1(q)}$	—	65	mA
Power Gain ($P_{out} = 2 W$, $V_{Cont} = 4 Vdc$)	G_p	33	—	dB
Efficiency ($P_{out} = 2 W$, $P_{in} = 1 mW$) (1)	η	37	—	%
Harmonics ($P_{out} = 2 W$) (1) $2 f_o$ ($P_{in} = 1 mW$) $3 f_o$	—	—	-45 -55	dBc
Input VSWR ($P_{out} = 2 W$, $P_{in} = 1 mW$), 50 Ω Ref. (1)	—	—	2.0:1	—
Noise power 30 kHz Bandwidth, 45 MHz above f_o ($P_{out} = 2 W$) (1) $T_C = +25^\circ C$ ($P_{in} = 1 mW$) $T_C = +100^\circ C$	— —	— —	-85 -82	dBm dBm
Load Mismatch ($V_{s1} = V_{s2} = V_{s3} = 10 Vdc$) VSWR = 10:1, $P_{out} = 3 W$, $P_{in} = 3 mW$ (1)				No Degradation in Power Output
Stability ($P_{in} = 0.5-2 mW$, $V_{s1} = V_{s2} = V_{s3} = 6-9 Vdc$) P_{out} between 0 mW and 2 W (1) Load VSWR = 6:1, Source VSWR = 3:1)				All spurious outputs more than 60 dB below desired signal

NOTES:

1. Adjust V_{cont} for specified P_{out} .
2. $V_{Cont} = 0 Vdc$.

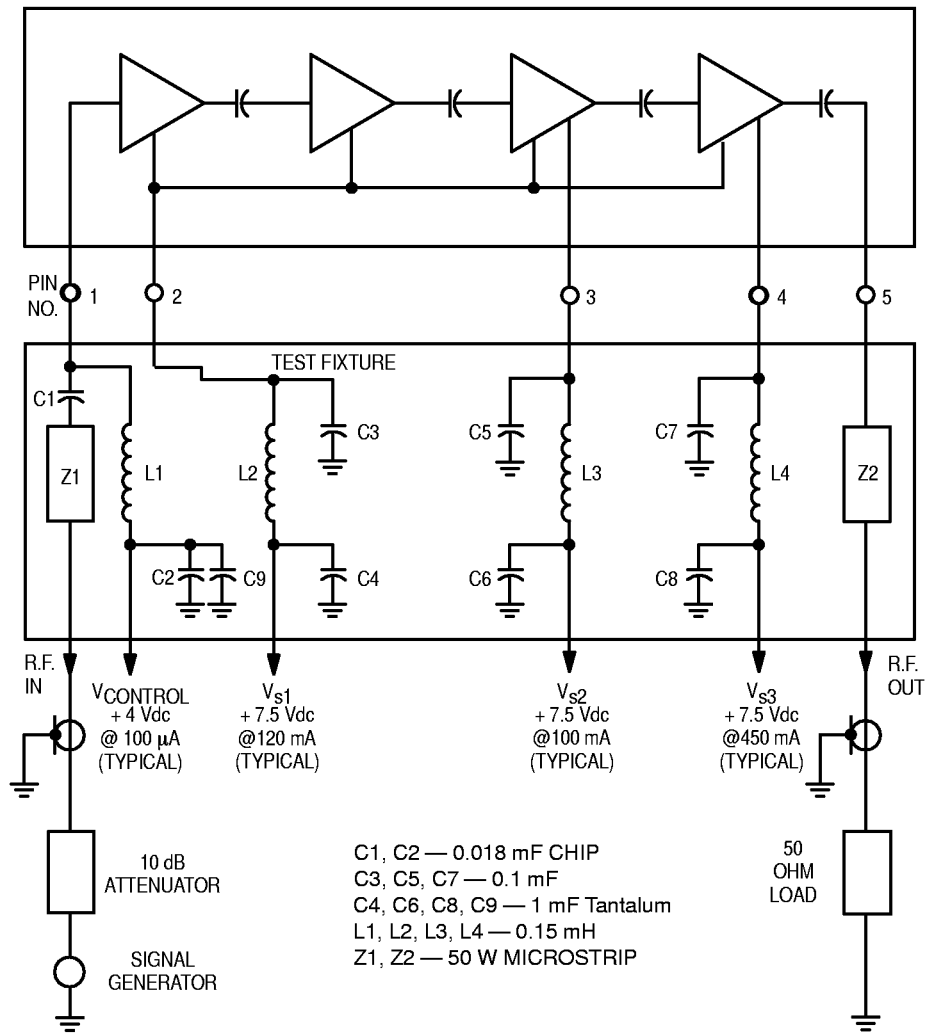

Figure 1. Power Module Test System Block Diagram

TYPICAL CHARACTERISTICS

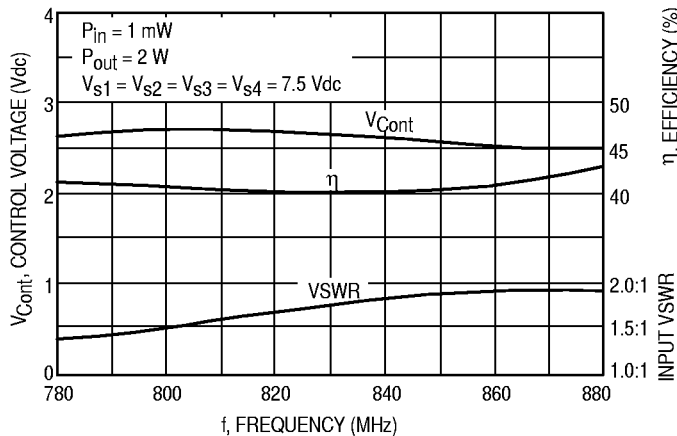

Figure 2. Control Voltage, Efficiency and VSWR versus Frequency

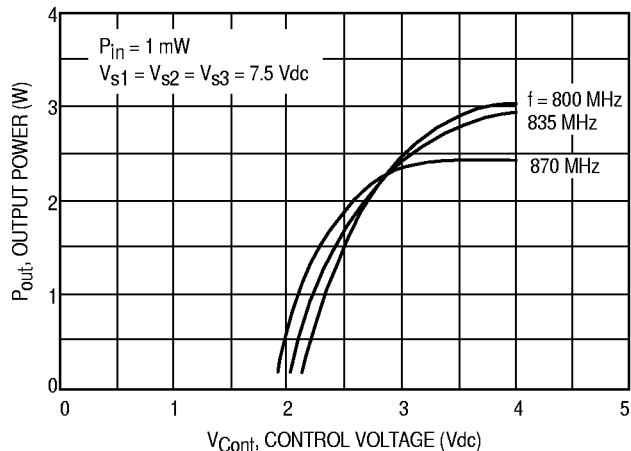

Figure 3. Output Power versus Control Voltage

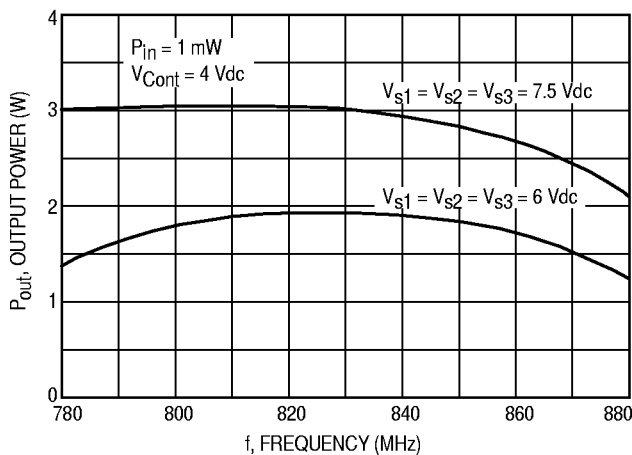

Figure 4. Output Power versus Frequency

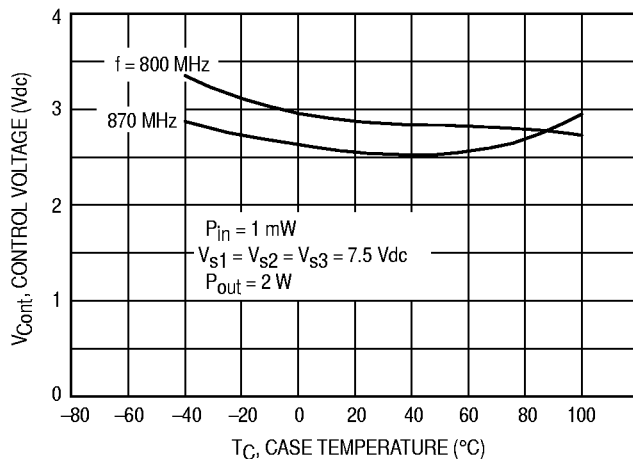

Figure 5. Control Voltage versus Case Temperature

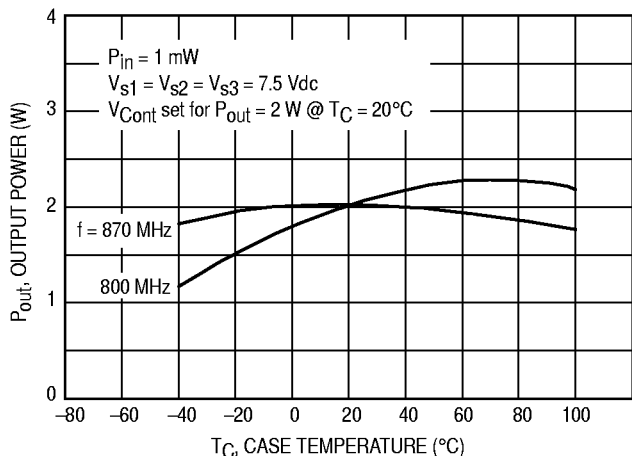

Figure 6. Output Power versus Case Temperature

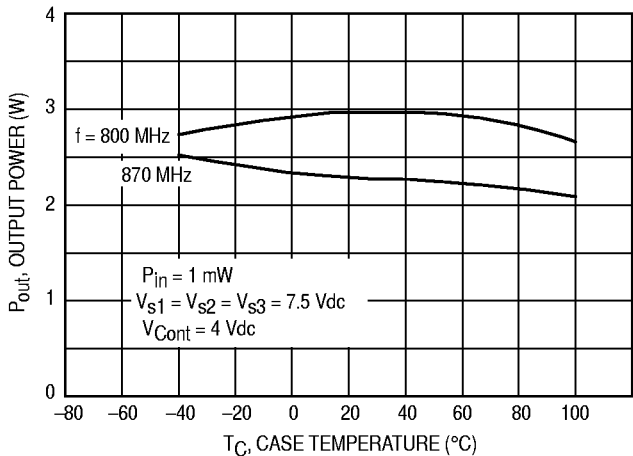

Figure 7. Output Power versus Case Temperature at Maximum Control Voltage

APPLICATIONS INFORMATION

NOMINAL OPERATION

All electrical specifications are based on the nominal conditions of $V_{S1} = V_{S2} = V_{S3} = 7.5$ Vdc (Pins 2, 3, 4) and P_{Out} equal to 2 watts. With these conditions, maximum current density on any device is 1.5×10^5 A/cm² and maximum die temperature with 100°C case operating temperature is 165°C. While the modules are designed to have excess gain margin with ruggedness, operation of these units outside the limits of published specifications is not recommended unless prior communications regarding intended use have been made with the factory representative.

GAIN CONTROL

The module output should be limited to 2 watts. The preferred method of power output control is to fix $V_{S1} = V_{S2} = V_{S3} = 7.5$ Vdc (Pins 2, 3, 4), P_{In} (Pin 1) at 1 mW, and vary V_{Cont} (Pin 1) voltage.

DECOUPLING

Due to the high gain of the three stages and the module size limitation, external decoupling networks require careful consideration. Pins 2, 3 and 4 are internally bypassed with a 0.018 μ F chip capacitor which is effective for frequencies from 5 MHz through 905 MHz. For bypassing frequencies below 5 MHz, networks equivalent to that shown in Figure 1 are recommended. Inadequate decoupling will result in spurious outputs at certain operating frequencies and certain phase angles of input and output VSWR.

LOAD MISMATCH

During final test, each module is load mismatch tested in a fixture having the identical decoupling networks described in Figure 1. Electrical conditions are $V_{S1} = V_{S2} = V_{S3}$ equal to 10 Vdc, VSWR equal to 10:1, and output power equal to 3 watts.

PACKAGE DIMENSIONS

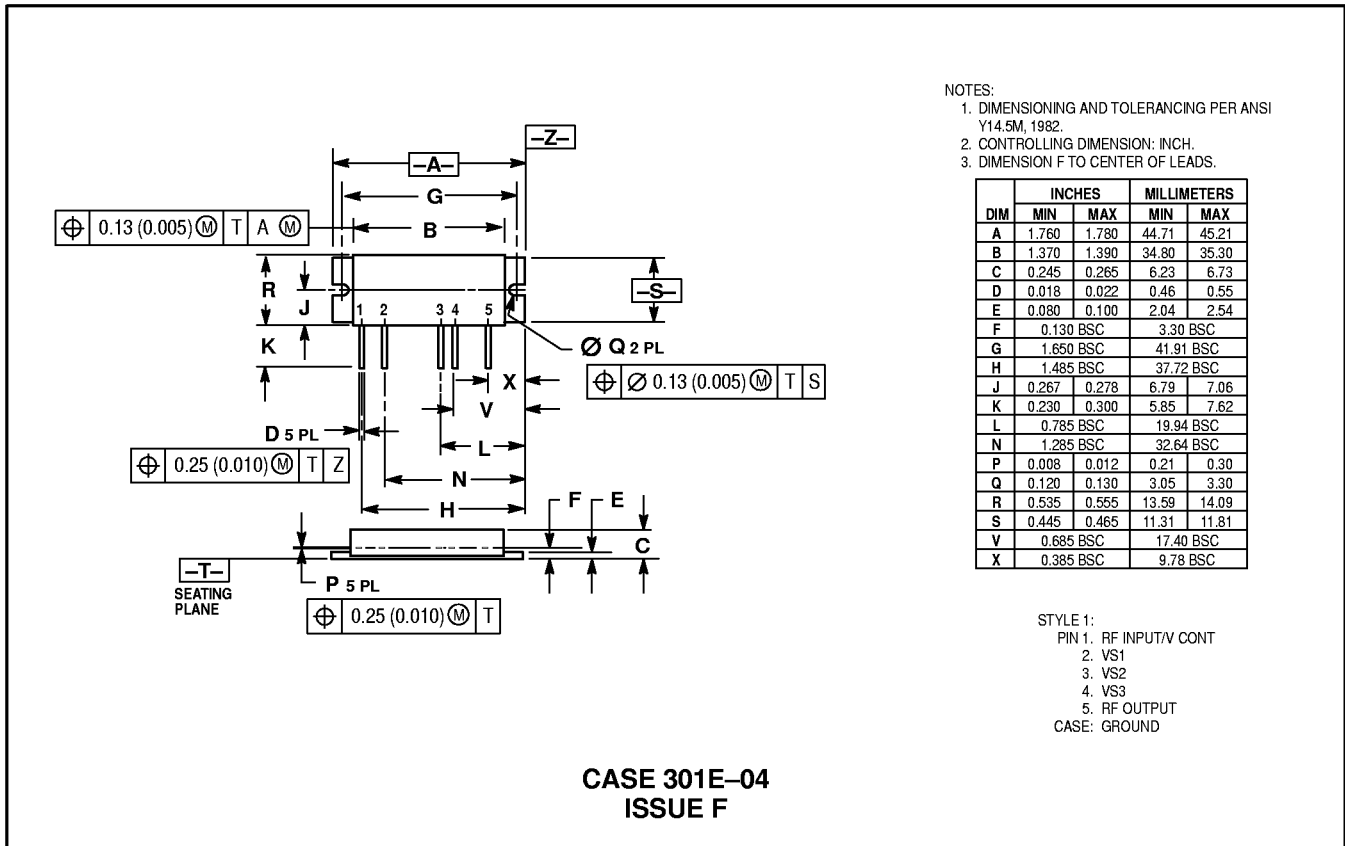

Motorola reserves the right to make changes without further notice to any products herein. Motorola makes no warranty, representation or guarantee regarding the suitability of its products for any particular purpose, nor does Motorola assume any liability arising out of the application or use of any product or circuit, and specifically disclaims any and all liability, including without limitation consequential or incidental damages. "Typical" parameters which may be provided in Motorola data sheets and/or specifications can and do vary in different applications and actual performance may vary over time. All operating parameters, including "Typicals" must be validated for each customer application by customer's technical experts. Motorola does not convey any license under its patent rights nor the rights of others. Motorola products are not designed, intended, or authorized for use as components in systems intended for surgical implant into the body, or other applications intended to support or sustain life, or for any other application in which the failure of the Motorola product could create a situation where personal injury or death may occur. Should Buyer purchase or use Motorola products for any such unintended or unauthorized application, Buyer shall indemnify and hold Motorola and its officers, employees, subsidiaries, affiliates, and distributors harmless against all claims, costs, damages, and expenses, and reasonable attorney fees arising out of, directly or indirectly, any claim of personal injury or death associated with such unintended or unauthorized use, even if such claim alleges that Motorola was negligent regarding the design or manufacture of the part. Motorola and are registered trademarks of Motorola, Inc. Motorola, Inc. is an Equal Opportunity/Affirmative Action Employer.

Mfax is a trademark of Motorola, Inc.

How to reach us:

USA / EUROPE / Locations Not Listed: Motorola Literature Distribution;
 P.O. Box 5405, Denver, Colorado 80217. 303-675-2140 or 1-800-441-2447

JAPAN: Nippon Motorola Ltd.: SPD, Strategic Planning Office, 4-32-1,
 Nishi-Gotanda, Shinagawa-ku, Tokyo 141, Japan. 81-3-5487-8488

Mfax™: RMFAX0@email.sps.mot.com - TOUCHTONE 602-244-6609
 - US & Canada ONLY 1-800-774-1848

ASIA / PACIFIC: Motorola Semiconductors H.K. Ltd.; 8B Tai Ping Industrial Park,
 51 Ting Kok Road, Tai Po, N.T., Hong Kong. 852-26629298

INTERNET: <http://motorola.com/sps>

