

4026B, 4033B  
**CD4026B, CD4033B Types**

**CMOS  
 Decade Counters/Dividers**

High-Voltage Types (20-Volt Rating)  
 With Decoded 7-Segment Display Outputs and:  
 Display Enable – CD4026B  
 Ripple Blanking – CD4033B

The RCA-CD4026B and CD4033B each consist of a 5-stage Johnson decade counter and an output decoder which converts the Johnson code to a 7-segment decoded output for driving one stage in a numerical display.

These devices are particularly advantageous in display applications where low power dissipation and/or low package count are important.

Inputs common to both types are CLOCK, RESET, & CLOCK INHIBIT; common outputs are CARRY OUT and the seven decoded outputs (a, b, c, d, e, f, g). Additional inputs and outputs for the CD4026B include DISPLAY ENABLE input and DISPLAY ENABLE and UNGATED "C" SEGMENT" outputs. Signals peculiar to the CD4033B are RIPPLE-BLANKING INPUT AND LAMP TEST INPUT and a RIPPLE-BLANKING OUTPUT.

A high RESET signal clears the decade counter to its zero count. The counter is advanced one count at the positive clock signal transition if the CLOCK INHIBIT signal is low. Counter advancement via the clock line is inhibited when the CLOCK INHIBIT signal is high. The CLOCK INHIBIT signal can be used as a negative-edge clock if the clock line is held high. Antilock gating is provided on the JOHNSON counter, thus assuring proper counting sequence. The CARRY-OUT ( $C_{out}$ ) signal completes one cycle every ten CLOCK INPUT cycles and is used to clock the succeeding decade directly in a multi-decade counting chain. The seven decoded outputs (a, b, c, d, e, f, g) illuminate the proper segments in a seven

- Features:**
- Counter and 7-segment decoding in one package
  - Easily interfaced with 7-segment display types
  - Fully static counter operation: DC to 6 MHz (typ.) at  $V_{DD}=10\text{ V}$
  - Ideal for low-power displays
  - Display enable output (CD4026B)
  - "Ripple blanking" and lamp test (CD4033B)
  - 100% tested for quiescent current at 20 V
  - Standardized, symmetrical output characteristics
  - 5-V, 10-V, and 15-V parametric ratings
  - Schmitt-triggered clock inputs
  - Meets all requirements of JEDEC Tentative Standard No. 13A, "Standard Specifications for Description of 'B' Series CMOS Devices"

- Applications**
- Decade counting 7-segment decimal display
  - Frequency division 7-segment decimal displays
  - Clocks, watches, timers (e.g.  $\div 60, \div 60, \div 12$  counter/display)
  - Counter/display driver for meter applications

segment display device used for representing the decimal numbers 0 to 9. The 7-segment outputs go high on selection in the CD4033B; in the CD4026B these outputs go high only when the DISPLAY ENABLE IN is high.

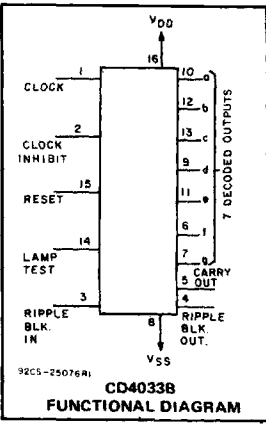
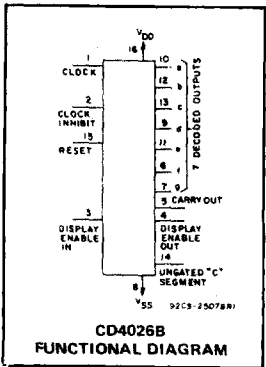

**TERMINAL DIAGRAMS**

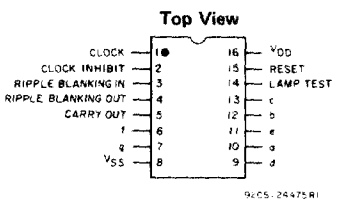
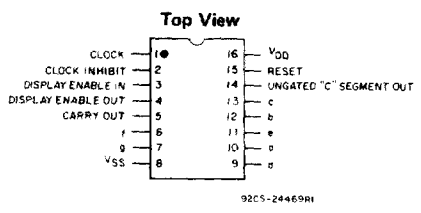

**MAXIMUM RATINGS, Absolute-Maximum Values:**

DC SUPPLY-VOLTAGE RANGE, ( $V_{DD}$ )	-0.5 to +20 V
(Voltages referenced to $V_{SS}$ Terminal)	
INPUT VOLTAGE RANGE, ALL INPUTS	-0.5 to $V_{DD} + 0.5\text{ V}$
DC INPUT CURRENT, ANY ONE INPUT	$\pm 10\text{ mA}$
POWER DISSIPATION PER PACKAGE ( $P_D$ ):	
For $T_A = -40$ to $+60^\circ\text{C}$ (PACKAGE TYPE E)	500 mW
For $T_A = +80$ to $+85^\circ\text{C}$ (PACKAGE TYPE E)	Derate Linearly at 12 mW/ $^\circ\text{C}$ to 200 mW
For $T_A = -55$ to $+100^\circ\text{C}$ (PACKAGE TYPES D, F, K)	500 mW
For $T_A = +100$ to $+125^\circ\text{C}$ (PACKAGE TYPES D, F, K)	Derate Linearly at 12 mW/ $^\circ\text{C}$ to 200 mW
DEVICE DISSIPATION PER OUTPUT TRANSISTOR	
For $T_A = \text{FULL PACKAGE-TEMPERATURE RANGE (All Package Types)}$	100 mW
OPERATING-TEMPERATURE RANGE ( $T_A$ ):	
PACKAGE TYPES D, F, K, H	-55 to $+125^\circ\text{C}$
PACKAGE TYPE E	-40 to $+85^\circ\text{C}$
STORAGE TEMPERATURE RANGE ( $T_{stg}$ )	-65 to $+150^\circ\text{C}$
LEAD TEMPERATURE (DURING SOLDERING):	
At distance 1/16 $\pm$ 1/32 inch (1.59 $\pm$ 0.79 mm) from case for 10 s max.	$+265^\circ\text{C}$

# CD4026B, CD4033B Types

## RECOMMENDED OPERATING CONDITIONS

For maximum reliability, nominal operating conditions should be selected so that operation is always within the following ranges:

CHARACTERISTIC	VDD (V)	LIMITS		UNITS
		MIN.	MAX.	
Supply-Voltage Range (For T <sub>A</sub> = Full Package Temperature Range)		3	18	V
Clock Input Frequency, f <sub>CL</sub>	5	—	2.5	MHz
	10	—	5.5	
	15	—	8	
Clock Pulse Width, t <sub>WCL</sub>	5	220	—	
	10	100	—	
	15	80	—	
Clock Rise and Fall Time, t <sub>rCL</sub> , t <sub>fCL</sub>	5	—	Unlimited	
	10	—		
	15	—		
Clock Inhibit Set Up Time, t <sub>SU</sub>	5	200	—	ns
	10	50	—	
	15	30	—	
Reset Pulse Width, t <sub>W</sub>	5	200	—	
	10	100	—	
	15	50	—	
Reset Removal Time	5	30	—	
	10	15	—	
	15	10	—	

## CD4026B

When the DISPLAY ENABLE IN is low the seven decoded outputs are forced low regardless of the state of the counter. Activation of the display only when required results in significant power savings. This system also facilitates implementation of display-character multiplexing.

The CARRY OUT and UNGATED "C-SEGMENT" signals are not gated by the DISPLAY ENABLE and therefore are available continuously. This feature is a requirement in implementation of certain divider functions such as divide-by-60 and divide-by-12.

## CD4033B

The CD4033B has provisions for automatic blanking of the non-significant zeros in a multi-digit decimal number which results in an easily readable display consistent with normal writing practice. For example, the number 0050.0700 in an eight digit display would be displayed as 50.07. Zero suppression on the integer side is obtained by connecting the RBI terminal of the CD4033B associated with the most significant digit in the display to a low-level voltage and connecting the RBO terminal of that stage to the RBI terminal of the CD4033B in the next-lower significant position in the display. This procedure is continued for each succeeding CD4033B on the integer side of the display.

## STATIC ELECTRICAL CHARACTERISTICS

CHARACTERISTIC	CONDITIONS			LIMITS AT INDICATED TEMPERATURES (°C)							UNITS
				Values at -55, +25, +125 Apply to D, F, K, H Packages Values at -40, +25, +85 Apply to E Package							
	VO (V)	VIN (V)	VDD (V)	-55	-40	+85	+125	Min.	Typ.	Max.	
Quiescent Device Current, I <sub>DD</sub> Max.	—	0.5	5	5	5	150	150	—	0.04	5	μA
	—	0.10	10	10	10	300	300	—	0.04	10	
	—	0.15	15	20	20	600	600	—	0.04	20	
	—	0.20	20	100	100	3000	3000	—	0.08	100	
Output Low (Sink) Current I <sub>OL</sub> Min.	0.4	0.5	5	0.64	0.61	0.42	0.36	0.51	1	—	mA
	0.5	0.10	10	1.6	1.5	1.1	0.9	1.3	2.6	—	
	1.5	0.15	15	4.2	4	2.8	2.4	3.4	6.8	—	
Output High (Source) Current, I <sub>OH</sub> Min.	4.6	0.5	5	-0.64	-0.61	-0.42	-0.36	-0.51	-1	—	mA
	2.5	0.5	5	-2	-1.8	-1.3	-1.15	-1.6	-3.2	—	
	9.5	0.10	10	-1.6	-1.5	-1.1	-0.9	-1.3	-2.6	—	
	13.5	0.15	15	-4.2	-4	-2.8	-2.4	-3.4	-6.8	—	
Output Voltage: Low-Level, VOL Max.	—	0.5	5	0.05				—	0	0.05	V
	—	0.10	10	0.05				—	0	0.05	
	—	0.15	15	0.05				—	0	0.05	
Output Voltage: High-Level, VOH Min.	—	0.5	5	4.95				4.95	5	—	V
	—	0.10	10	9.95				9.95	10	—	
	—	0.15	15	14.95				14.95	15	—	
Input Low Voltage, V <sub>IL</sub> Max.	0.5, 4.5	—	5	1.5				—	—	1.5	V
	1.9	—	10	3				—	—	3	
	1.5, 13.5	—	15	4				—	—	4	
Input High Voltage, V <sub>IH</sub> Min.	0.5, 4.5	—	5	3.5				3.5	—	—	V
	1.9	—	10	7				7	—	—	
	1.5, 13.5	—	15	11				11	—	—	
Input Current I <sub>IN</sub> Max.	—	0.18	18	±0.1	±0.1	±1	±1	—	±10 <sup>-5</sup>	±0.1	μA

On the fraction side of the display the RBI of the CD4033B associated with the least significant bit is connected to a low-level voltage and the RBO of that CD4033B is connected to the RBI terminal of the CD4033B in the next more-significant-bit position. Again, this procedure is continued for all CD4033B's on the fraction side of the display.

In a purely fractional number the zero immediately preceding the decimal point can be displayed by connecting the RBI of that stage to a high level voltage (instead of to the RBO of the next more-significant-stage). For example: optional zero → 0.7346. Likewise, the zero in a number such as 763.0 can be displayed by connecting the RBI of the CD4033B associated with it to a high-level voltage.

Ripple blanking of non-significant zeros provides an appreciable savings in display power.

The CD4033B has a LAMP TEST input which, when connected to a high-level voltage, overrides normal decoder operation and enables a check to be made on possible display malfunctions by putting the seven outputs in the high state.

The CD4026B- and CD4033B-series types are supplied in 16-lead hermetic dual-in-line ceramic packages (D and F suffixes), 16-lead dual-in-line plastic packages (E suffix), 16-lead ceramic flat packages (K suffix), and in chip form (H suffix).

# CD4026B, CD4033B Types

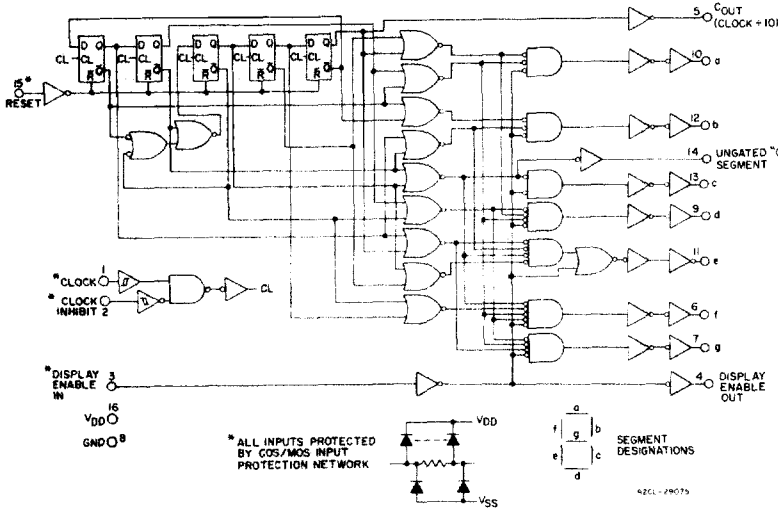

Fig. 1 - CD4026B logic diagram.

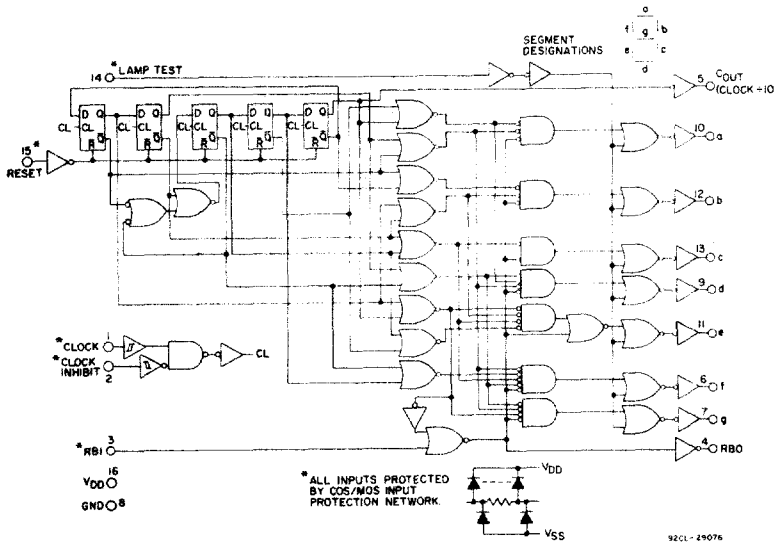

Fig. 2 - CD4033B logic diagram.

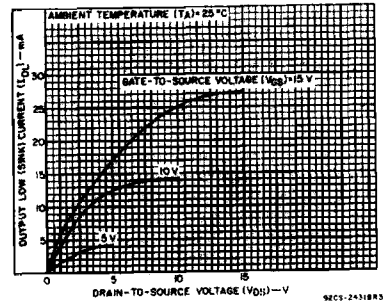

Fig. 6 - Typical n-channel output low (sink) current characteristics.

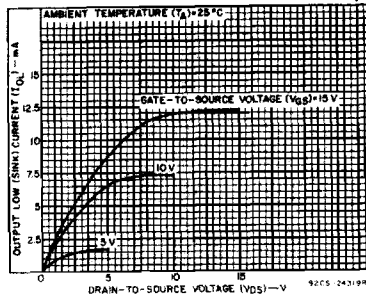

Fig. 7 - Minimum n-channel output low (sink) current characteristics.

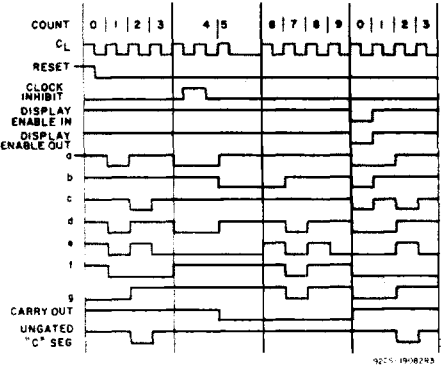

Fig. 3 - CD4026B timing diagram.

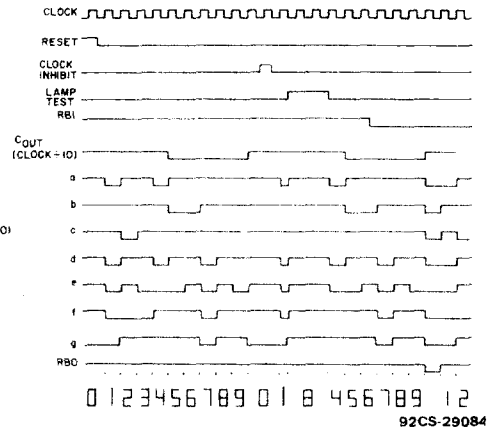

Fig. 4 - CD4033B timing diagram.

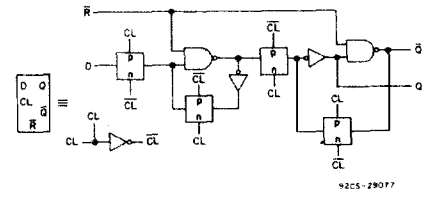

Fig. 5 - Detail of typical flip-flop stage for both types.

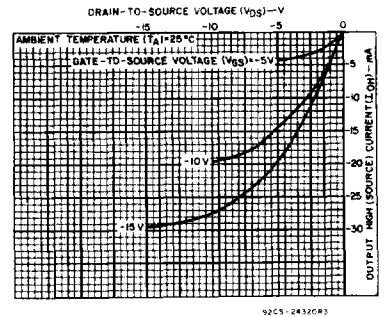

Fig. 8 - Typical p-channel output high (source) current characteristics.

# CD4026B, CD4033B Types

**DYNAMIC ELECTRICAL CHARACTERISTICS** at  $T_A = 25^\circ\text{C}$ , Input  $t_r, t_f = 20\text{ ns}$ ,  
 $C_L = 50\text{ pF}$ ,  $R_L = 200\text{ k}\Omega$

CHARACTERISTIC	TEST CONDITIONS	LIMITS			UNITS	
		VDD (V)	Min.	Typ.		Max.
<b>CLOCKED OPERATION</b>						
Propagation Delay Time; Carry-Out Line $t_{PLH}, t_{PHL}$		5	—	250	500	
		10	—	100	200	
		15	—	75	150	
Decode Outlines		5	—	350	700	ns
		10	—	125	250	
		15	—	90	180	
Transition Time; Carry-Out Line $t_{THL}, t_{TLH}$		5	—	100	200	
		10	—	50	100	
		15	—	25	50	
Maximum Clock Input Frequency, $f_{CL}^{\Delta}$		5	2.5	5	—	MHz
		10	5.5	11	—	
		15	8	16	—	
Min. Clock Pulse Width, $t_W$		5	—	110	220	
		10	—	50	100	
		15	—	40	80	
Clock and Clock Inhibit Rise or Fall Time; $t_{rCL}, t_{fCL}$		5	Unlimited		ns	
		10	Unlimited			
		15	Unlimited			
Average Input Capacitance, $C_{IN}$	Any Input	—	5	7	pF	
<b>RESET OPERATION</b>						
Propagation Delay Time; To Carry-Out Line, $t_{PLH}$		5	—	275	550	
		10	—	120	240	
		15	—	80	160	
To Decode Out Lines, $t_{PHL}, t_{PLH}$		5	—	300	600	ns
		10	—	125	250	
		15	—	90	180	
Min. Reset Pulse Width, $t_W$		5	—	100	120	
		10	—	50	100	
		15	—	25	50	
Min. Reset Removal Time		5	—	0	30	
		10	—	0	15	
		15	—	0	10	

$\Delta$  Measured with respect to carry-out line.

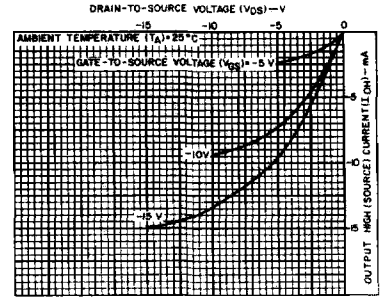

Fig. 9 — Minimum p-channel output high (source) current characteristics.

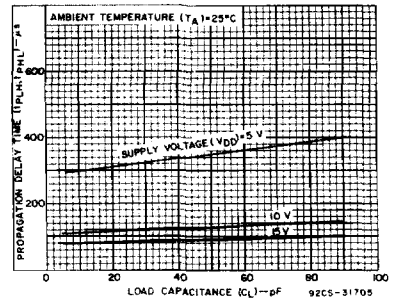

Fig. 10 — Typical propagation delay time as a function of load capacitance for decoded outputs.

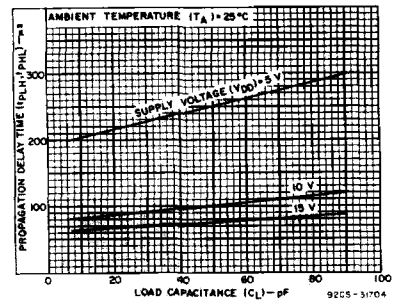

Fig. 11 — Typical propagation delay time as a function of load capacitance for carry-out outputs.

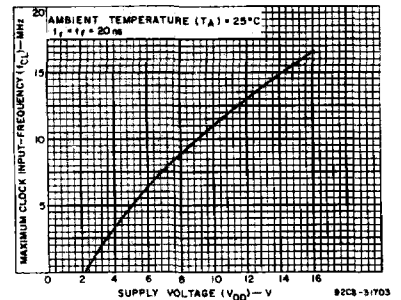

Fig. 12 — Typical maximum clock input frequency as a function of supply voltage.

# CD4026B, CD4033B Types

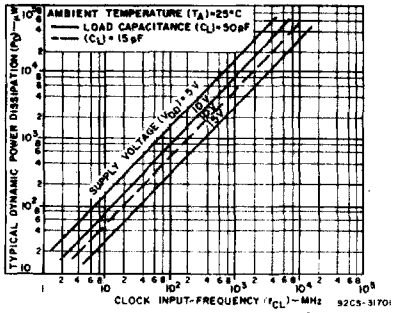

Fig. 13 - Typical power dissipation as a function of clock input frequency.

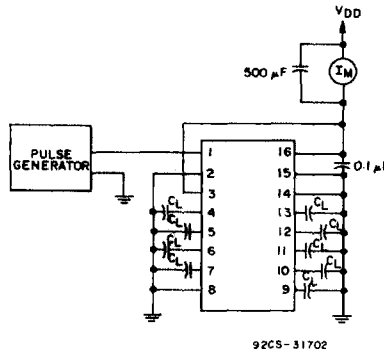

Fig. 14 - Dynamic power dissipation test circuit for CD4033B.

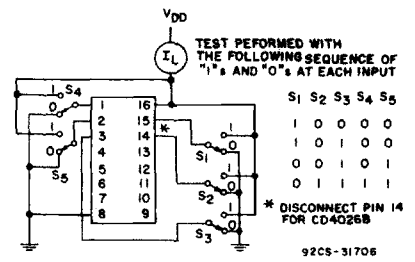
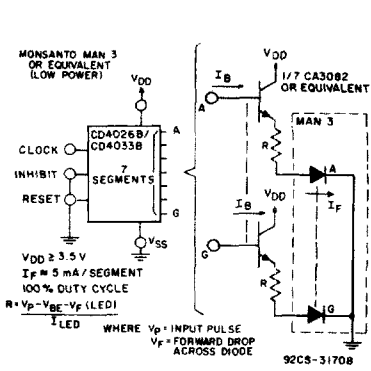
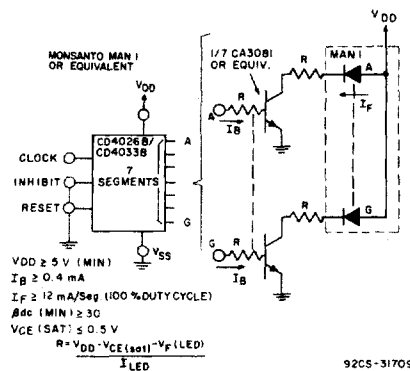

Fig. 15 - Quiescent device current.

## INTERFACING THE CD4026B AND CD4033B WITH COMMERCIALY AVAILABLE LIGHT EMITTING DIODE DISPLAYS



92CS-3170B



92CS-31709

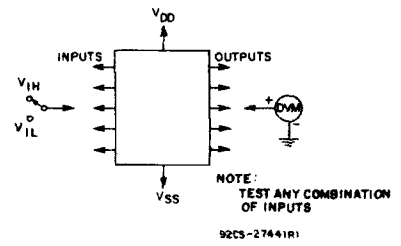

Fig. 16 - Input voltage.

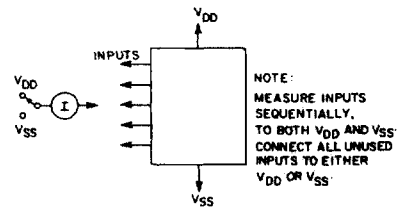
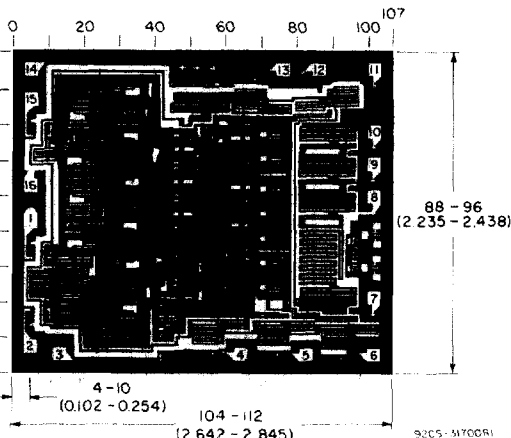
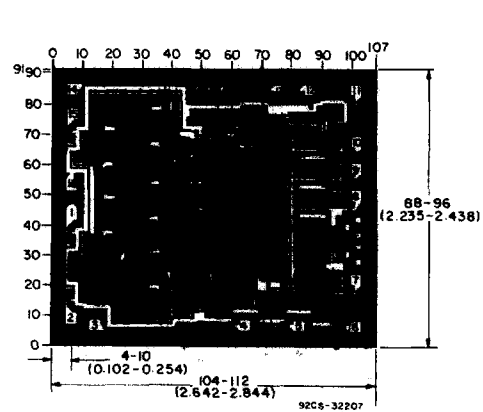

Fig. 17 - Input current.



Dimensions and pad layout for CD4026B.

Dimensions in parentheses are in millimeters and are derived from the basic inch dimensions as indicated. Grid graduations are in mils (10<sup>-3</sup> inch).



Dimensions and pad layout for CD4033B.

The photographs and dimensions of each CMOS chip represent a chip when it is part of the wafer. When the wafer is separated into individual chips, the angle of cleavage may vary with respect to the chip face for different chips. The actual dimensions of the isolated chip, therefore, may differ slightly from the nominal dimensions shown. The user should consider a tolerance of -3 mils to +16 mils applicable to the nominal dimensions shown.

# CD4026B, CD4033B Types

## INTERFACING THE CD4026B AND CD4033B WITH COMMERCIALY AVAILABLE 7-SEGMENT DISPLAY DEVICES\* (Refer to RCA Application Note ICAN-6733 for detailed interfacing information)

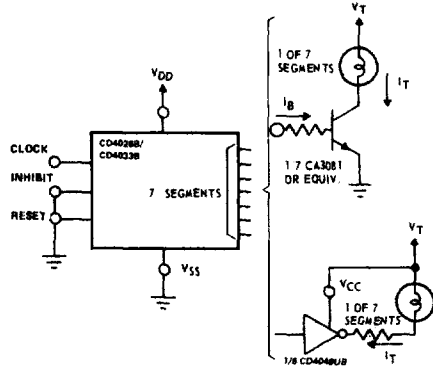

### INCANDESCENT READOUTS RCA Numitron DR2000 Series TUBE REQUIREMENTS

$V_T = 3.5-5V$   
 $I_T = 24 \text{ mA Segment}$

ASSUMED TRANSISTOR CHARACTERISTICS @  $V_{CC} = 10 \text{ V (min.)}$   
 $\beta_{dc} (\text{min.}) \geq 25$   
 $V_{CE(sat.)} \leq 0.5 \text{ V}$   
 $V_{DD} = 8 \text{ V (min.)}$   
 $I_B = 1 \text{ mA (min.)}$   
 $I_T = 24 \text{ mA (min.)}$

CD4049UB  
 $V_{CC} = 10 \text{ V (min.)}$   
 $V_o '0' \leq 2 \text{ V}$   
 $I_T = 8 \text{ mA (min.)}$   
 $V_T \geq 3.5 \text{ V TO } 6 \text{ V}$

CD4049UB  
 $V_{CC} = 10 \text{ V (min.)}$   
 $V_o '0' \leq 0.6 \text{ V}$   
 $I_T = 8 \text{ mA (min.)}$   
  
@  $V_{CC} = 6 \text{ V (min.)}$   
 $V_o '0' \leq 1 \text{ V}$   
 $I_T = 5 \text{ mA (min.)}$   
 $V_T \geq 1.5 \text{ V TO } 3.5 \text{ V}$

### LOW-POWER INCANDESCENT READOUTS

PINLITES INC-Series O and R

TUBE REQUIREMENTS	$V_T$ (V)	mA/Segment
O-03-15	1.5	8
O-04-30	3	8
O-06-30	3	8
R-R3-20	2	4.3
R-R4-30	3	4.3

### ASSUMED TRANSISTOR CHARACTERISTICS

$\beta_{dc} (\text{min.}) \geq 30$   
 $V_{CE(sat.)} \leq 0.5 \text{ V}$   
 $V_{CC} \geq 3.5 \text{ V (min.)}$   
 $I_B \geq 0.25 \text{ mA (min.)}$   
 $I_T \leq 7.5 \text{ mA (min.)}$

92CM-31707

\* The interfacing buffers shown, while a necessity with the CD4026A and CD4033A, are not required when using the "B" devices; the "B" outputs ( $\approx 10$  times the "A" outputs) can drive most display devices directly especially at voltages above 10 V.

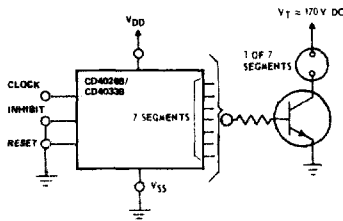

### NEON READOUT (NIXIE TUBE<sup>†</sup>)

- Alco Electronics - MG19
- Burroughs - B5971, B7971, B8971

TUBE REQUIREMENTS	$V_T$ (Vdc)	mA Segment
Alco MG19	180	0.5
Burroughs B5971	170	3
Burroughs B7971, B8971	170	6

<sup>†</sup> (Trademark) Burroughs Corp.

### TRANSISTOR CHARACTERISTICS

Leakage with transistor cutoff - 0.05 mA  
 $V_{(BR)CER} > V_T$

$\beta_{dc} (\text{min.}) > 30$  92CS-31711

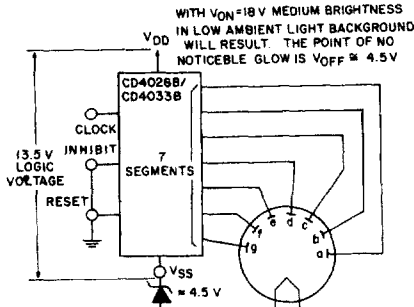

### LOW VOLTAGE VACUUM FLUORESCENT READOUTS

- Tung Sol DIGIVAC S/G ‡ Type DT1704A or DT1705C
  - Nippon Electric (NEC); Type DG12E or LD915
- TUBE REQUIREMENTS: 100 to 300  $\mu\text{A}$ /segment at tube voltages of 12 V to 25 V depending on required brightness. Filament requirement 45 mA at 1.6 V, ac or dc.

‡ (Trademark) Wagner Electric Co.

92CS-31711