



DVTR2800S Series

HIGH RELIABILITY HYBRID DC-DC CONVERTERS

DESCRIPTION

The DVTR series of high reliability DC-DC converters is operable over the full military (-55 °C to +125 °C) temperature range with no power derating. Unique to the DVTR series are robust and effective input and output filters which provide dramatically reduced input and output noise performance when compared to other manufacturers competing devices. Operating at a nominal fixed frequency of 475 kHz, these regulated, isolated units utilize a high speed magnetic feedback design and well controlled undervoltage lockout circuitry to eliminate slow start-up problems.

These converters are designed and manufactured in a facility qualified to ISO9001 and certified to MIL-PRF-38534 and MIL-STD-883.

This product may incorporate one or more of the following U.S. patents:

- 5,784,266
- 5,790,389
- 5,963,438
- 5,999,433
- 6,005,780
- 6,084,792
- 6,118,673

FEATURES

- High Reliability
- Very Low Output Noise
- Wide Input Voltage Range: 15 to 50 Volts per MIL-STD-704
- Up to 40 Watts Output Power
- Fault Tolerant Magnetic Feedback Circuit
- Output Voltage Trim Up +10%
- NO Use of Optoisolators
- Undervoltage Lockout
- Indefinite Short Circuit Protection
- Current Limit Protection
- Industry Standard Pinout
- High Input Transient Voltage: 80 Volts for 1 sec per MIL-STD-704A
- Precision Seam Seal Hermetic Package
- High Power Density: > 40 W/in³
- Custom Versions Available
- Additional Environmental Screening Available
- Meets MIL-STD-461 Revisions C, D, E and F EMC Requirements When Used With VPT's EMI Filters
- Flanged and Non-flanged Versions Available
- MIL-PRF-38534 Element Evaluated Components
- Space Applications should consider VPT's "S" Series of Radiation Tolerant Power Conversion Devices. Contact VPT for details.

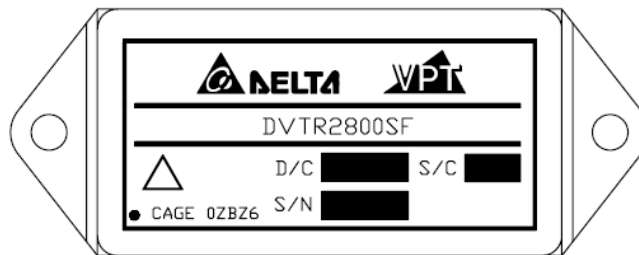

Figure 1 – DVTR2800S / DVTR2800SF DC-DC Converter
(Exact marking may differ from that shown)

SPECIFICATIONS (T_{CASE} = -55°C to +125°C, V_{IN} = +28V ± 5%, Full Load, Unless Otherwise Specified)

ABSOLUTE MAXIMUM RATINGS

Input Voltage (Continuous)	50 V _{DC}	Junction Temperature Rise to Case	+15°C
Input Voltage (Transient, 1 second)	80 Volts	Storage Temperature	-65°C to +150°C
Output Power ¹	40 Watts	Lead Solder Temperature (10 seconds)	270°C
Power Dissipation (Full Load, T _{CASE} = +125°C)	13 Watts	Weight (Maximum) (Un-Flanged / Flanged)	(52 / 55) Grams
ESD Rating per MIL-PRF-38534	3A		

Parameter	Conditions	DVTR282R5S			DVTR283R3S			Units
		Min	Typ	Max	Min	Typ	Max	
STATIC								
INPUT Voltage ⁴	Continuous	15	28	50	15	28	50	V
	Transient, 1 sec	-	-	80	-	-	80	V
Current	Inhibited	-	4	6	-	4	6	mA
	No Load	-	50	90	-	50	90	mA
Ripple Current	Full Load, 20Hz to 10MHz	-	15	50	-	20	50	mA _{p-p}
Inhibit Pin Input ⁴		0	-	1.5	0	-	1.5	V
Inhibit Pin Open Circuit Voltage ⁴		9.0	11.0	13.0	9.0	11.0	13.0	V
UVLO Turn On		12.0	-	14.8	12.0	-	14.8	V
UVLO Turn Off ⁴		11.0	-	14.5	11.0	-	14.5	V
OUTPUT Voltage	V _{OUT} T _{CASE} = 25°C	2.47	2.5	2.53	3.25	3.3	3.35	V
	V _{OUT} T _{CASE} = -55°C to +125°C	2.46	2.5	2.54	3.2	3.3	3.4	V
Power ³		0	-	15	0	-	20	W
Current ³	V _{OUT}	0	-	6.0	0	-	6.06	A
Ripple Voltage	V _{OUT} Full Load, 20Hz to 10MHz	-	20	50	-	25	50	mV _{p-p}
Line Regulation	V _{OUT} V _{IN} = 15V to 50V	-	2	20	-	2	20	mV
Load Regulation	V _{OUT} No Load to Full Load	-	2	50	-	2	50	mV
EFFICIENCY		63	66	-	65	70	-	%
LOAD FAULT POWER DISSIPATION ⁴	Overload	-	-	18	-	-	16	W
	Short Circuit	-	-	18	-	-	16	W
CAPACITIVE LOAD ⁴		-	-	1000	-	-	1000	μF
SWITCHING FREQUENCY		400	475	550	400	475	550	kHz
SYNC FREQUENCY RANGE	V _H - V _L = 5V, DC = 20-80%	500	-	600	500	-	600	kHz
ISOLATION	500 V _{DC}	100	-	-	100	-	-	MΩ
MTBF (MIL-HDBK-217F)	AIF @ T _C = 55°C	-	413	-	-	413	-	kHrs
DYNAMIC								
Load Step Output Transient	V _{OUT} Half Load to Full Load	-	90	400	-	180	500	mV _{PK}
Load Step Recovery ²		-	280	500	-	260	500	μSec
Line Step Output Transient ⁴	V _{OUT} V _{IN} = 16V to 40V	-	300	450	-	300	600	mV _{PK}
Line Step Recovery ^{2, 4}		-	300	450	-	300	500	μSec
Turn On Delay	V _{OUT} V _{IN} = 0V to 28V	-	10	20	-	10	20	mSec
Turn On Overshoot		-	0	15	-	0	15	mV _{PK}

Notes: 1. Dependant on output voltage. 2. Time for output voltage to settle within 1% of its nominal value.
3. Derate linearly to 0 at 135°C. 4. Verified by qualification testing.

SPECIFICATIONS (T_{CASE} = -55°C to +125°C, V_{IN} = +28V ± 5%, Full Load, Unless Otherwise Specified)

ABSOLUTE MAXIMUM RATINGS

Input Voltage (Continuous)	50 V _{DC}	Junction Temperature Rise to Case	+15°C
Input Voltage (Transient, 1 second)	80 Volts	Storage Temperature	-65°C to +150°C
Output Power ¹	40 Watts	Lead Solder Temperature (10 seconds)	270°C
Power Dissipation (Full Load, T _{CASE} = +125°C)	13 Watts	Weight (Maximum) (Un-Flanged / Flanged)	(52 / 55) Grams
ESD Rating per MIL-PRF-38534	3A		

Parameter	Conditions	DVTR2805S			DVTR285R2S			Units
		Min	Typ	Max	Min	Typ	Max	
STATIC								
INPUT Voltage ⁴	Continuous	15	28	50	15	28	50	V
	Transient, 1 sec	-	-	80	-	-	80	V
Current	Inhibited	-	4	6	-	4	6	mA
	No Load	-	55	90	-	55	90	mA
Ripple Current	Full Load, 20Hz to 10MHz	-	30	50	-	30	50	mA _{p-p}
Inhibit Pin Input ⁴		0	-	1.5	0	-	1.5	V
Inhibit Pin Open Circuit Voltage ⁴		9.0	11.0	13.0	9.0	11.0	13.0	V
UVLO Turn On		12.0	-	14.8	12.0	-	14.8	V
UVLO Turn Off ⁴		11.0	-	14.5	11.0	-	14.5	V
OUTPUT Voltage	V _{OUT} T _{CASE} = 25°C	4.95	5	5.05	5.14	5.2	5.26	V
	V _{OUT} T _{CASE} = -55°C to +125°C	4.875	5	5.125	5.07	5.2	5.33	V
Power ³		0	-	30	0	-	30	W
Current ³	V _{OUT}	0	-	6	0	-	6	A
Ripple Voltage	V _{OUT} Full Load, 20Hz to 10MHz	-	20	50	-	20	50	mV _{p-p}
Line Regulation	V _{OUT} V _{IN} = 15V to 50V	-	2	20	-	2	20	mV
Load Regulation	V _{OUT} No Load to Full Load	-	2	50	-	2	50	mV
EFFICIENCY		72	78	-	72	78	-	%
LOAD FAULT POWER DISSIPATION ⁴	Overload	-	-	16	-	-	16	W
	Short Circuit	-	-	16	-	-	16	W
CAPACITIVE LOAD ⁴		-	-	1000	-	-	1000	μF
SWITCHING FREQUENCY		400	475	550	400	475	550	kHz
SYNC FREQUENCY RANGE	V _H - V _L = 5V, DC = 20-80%	500	-	600	500	-	600	kHz
ISOLATION	500 V _{DC}	100	-	-	100	-	-	MΩ
MTBF (MIL-HDBK-217F)	AIF @ T _C = 55°C	-	413	-	-	413	-	kHrs
DYNAMIC								
Load Step Output Transient	V _{OUT} Half Load to Full Load	-	170	500	-	170	500	mV _{PK}
Load Step Recovery ²		-	60	500	-	60	500	μSec
Line Step Output Transient ⁴	V _{OUT} V _{IN} = 16V to 40V	-	300	600	-	300	600	mV _{PK}
Line Step Recovery ^{2, 4}		-	300	500	-	300	500	μSec
Turn On Delay	V _{OUT} V _{IN} = 0V to 28V	-	10	20	-	10	20	mSec
Turn On Overshoot		-	0	25	-	0	25	mV _{PK}

Notes: 1. Dependant on output voltage. 2. Time for output voltage to settle within 1% of its nominal value.
3. Derate linearly to 0 at 135°C. 4. Verified by qualification testing.

SPECIFICATIONS (T_{CASE} = -55°C to +125°C, V_{IN} = +28V ± 5%, Full Load, Unless Otherwise Specified)

ABSOLUTE MAXIMUM RATINGS

Input Voltage (Continuous)	50 V _{DC}	Junction Temperature Rise to Case	+15°C
Input Voltage (Transient, 1 second)	80 Volts	Storage Temperature	-65°C to +150°C
Output Power ¹	40 Watts	Lead Solder Temperature (10 seconds)	270°C
Power Dissipation (Full Load, T _{CASE} = +125°C)	13 Watts	Weight (Maximum) (Un-Flanged / Flanged)	(52 / 55) Grams
ESD Rating per MIL-PRF-38534	3A		

Parameter	Conditions	DVTR2807S			DVTR2808S			Units
		Min	Typ	Max	Min	Typ	Max	
STATIC								
INPUT Voltage ⁴	Continuous	15	28	50	15	28	50	V
	Transient, 1 sec	-	-	80	-	-	80	V
Current	Inhibited	-	4	6	-	4	6	mA
	No Load	-	65	90	-	65	90	mA
Ripple Current	Full Load, 20Hz to 10MHz	-	30	50	-	30	50	mA _{p-p}
Inhibit Pin Input ⁴		0	-	1.5	0	-	1.5	V
Inhibit Pin Open Circuit Voltage ⁴		9.0	11.0	13.0	9.0	11.0	13.0	V
UVLO Turn On		12.0	-	14.8	12.0	-	14.8	V
UVLO Turn Off ⁴		11.0	-	14.5	11.0	-	14.5	V
OUTPUT Voltage	V _{OUT} T _{CASE} = 25°C	6.93	7	7.07	7.92	8	8.08	V
	V _{OUT} T _{CASE} = -55°C to +125°C	6.895	7	7.105	7.88	8	8.12	V
Power ³		0	-	35	0	-	35	W
Current ³	V _{OUT}	0	-	5	0	-	4.4	A
Ripple Voltage	V _{OUT} Full Load, 20Hz to 10MHz	-	30	50	-	30	50	mV _{p-p}
Line Regulation	V _{OUT} V _{IN} = 15V to 50V	-	2	20	-	2	20	mV
Load Regulation	V _{OUT} No Load to Full Load	-	2	50	-	2	50	mV
EFFICIENCY		72	76	-	75	79	-	%
LOAD FAULT POWER DISSIPATION ⁴	Overload	-	-	16	-	-	16	W
	Short Circuit	-	-	16	-	-	16	W
CAPACITIVE LOAD ⁴		-	-	1000	-	-	1000	μF
SWITCHING FREQUENCY		400	475	550	400	475	550	kHz
SYNC FREQUENCY RANGE	V _H - V _L = 5V, DC = 20-80%	500	-	600	500	-	600	kHz
ISOLATION	500 V _{DC}	100	-	-	100	-	-	MΩ
MTBF (MIL-HDBK-217F)	AIF @ T _C = 55°C	-	413	-	-	413	-	kHrs
DYNAMIC								
Load Step Output Transient	V _{OUT} Half Load to Full Load	-	150	300	-	110	250	mV _{PK}
Load Step Recovery ²		-	100	250	-	60	250	μSec
Line Step Output Transient ⁴	V _{OUT} V _{IN} = 16V to 40V	-	250	500	-	250	500	mV _{PK}
Line Step Recovery ^{2, 4}		-	250	400	-	250	500	μSec
Turn On Delay	V _{OUT} V _{IN} = 0V to 28V	-	10	20	-	10	20	mSec
Turn On Overshoot		-	0	25	-	0	25	mV _{PK}

Notes: 1. Dependant on output voltage. 2. Time for output voltage to settle within 1% of its nominal value.
3. Derate linearly to 0 at 135°C. 4. Verified by qualification testing.

SPECIFICATIONS (T_{CASE} = -55°C to +125°C, V_{IN} = +28V ± 5%, Full Load, Unless Otherwise Specified)

ABSOLUTE MAXIMUM RATINGS

Input Voltage (Continuous)	50 V _{DC}	Junction Temperature Rise to Case	+15°C
Input Voltage (Transient, 1 second)	80 Volts	Storage Temperature	-65°C to +150°C
Output Power ¹	40 Watts	Lead Solder Temperature (10 seconds)	270°C
Power Dissipation (Full Load, T _{CASE} = +125°C)	13 Watts	Weight (Maximum) (Un-Flanged / Flanged)	(52 / 55) Grams
ESD Rating per MIL-PRF-38534	3A		

Parameter	Conditions	DVTR289R5S			DVTR2812S			Units
		Min	Typ	Max	Min	Typ	Max	
STATIC								
INPUT Voltage ⁴	Continuous	15	28	50	15	28	50	V
	Transient, 1 sec	-	-	80	-	-	80	V
Current	Inhibited	-	4	6	-	4	6	mA
	No Load	-	63	90	-	60	90	mA
Ripple Current	Full Load, 20Hz to 10MHz	-	30	50	-	30	50	mA _{p-p}
Inhibit Pin Input ⁴		0	-	1.5	0	-	1.5	V
Inhibit Pin Open Circuit Voltage ⁴		9.0	11.0	13.0	9.0	11.0	13.0	V
UVLO Turn On		12.0	-	14.8	12.0	-	14.8	V
UVLO Turn Off ⁴		11.0	-	14.5	11.0	-	14.5	V
OUTPUT Voltage	V _{OUT} T _{CASE} = 25°C	9.4	9.5	9.6	11.88	12	12.12	V
	V _{OUT} T _{CASE} = -55°C to +125°C	9.35	9.5	9.64	11.7	12	12.3	V
Power ³		0	-	40	0	-	40	W
Current ³	V _{OUT}	0	-	4.21	0	-	3.33	A
Ripple Voltage	V _{OUT} Full Load, 20Hz to 10MHz	-	30	50	-	20	50	mV _{p-p}
Line Regulation	V _{OUT} V _{IN} = 15V to 50V	-	2	20	-	2	20	mV
Load Regulation	V _{OUT} No Load to Full Load	-	2	50	-	10	50	mV
EFFICIENCY		76	82	-	76	84	-	%
LOAD FAULT POWER DISSIPATION ⁴	Overload	-	-	16	-	-	14	W
	Short Circuit	-	-	16	-	-	14	W
CAPACITIVE LOAD ⁴		-	-	500	-	-	500	μF
SWITCHING FREQUENCY		400	475	550	400	475	550	kHz
SYNC FREQUENCY RANGE	V _H - V _L = 5V, DC = 20-80%	500	-	600	500	-	600	kHz
ISOLATION	500 V _{DC}	100	-	-	100	-	-	MΩ
MTBF (MIL-HDBK-217F)	AIF @ T _C = 55°C	-	413	-	-	413	-	kHrs
DYNAMIC								
Load Step Output Transient	V _{OUT} Half Load to Full Load	-	500	700	-	450	700	mV _{PK}
Load Step Recovery ²		-	200	500	-	200	500	μSec
Line Step Output Transient ⁴	V _{OUT} V _{IN} = 16V to 40V	-	900	1500	-	500	900	mV _{PK}
Line Step Recovery ^{2, 4}	P _{OUT} = 30W	-	300	500	-	300	500	μSec
Turn On Delay	V _{OUT} V _{IN} = 0V to 28V	-	10	20	-	10	20	μSec
Turn On Overshoot		-	0	50	-	0	50	mV _{PK}

Notes: 1. Dependant on output voltage. 2. Time for output voltage to settle within 1% of its nominal value.
3. Derate linearly to 0 at 135°C. 4. Verified by qualification testing.

SPECIFICATIONS (T_{CASE} = -55°C to +125°C, V_{IN} = +28V ± 5%, Full Load, Unless Otherwise Specified)

ABSOLUTE MAXIMUM RATINGS

Input Voltage (Continuous)	50 V _{DC}	Junction Temperature Rise to Case	+15°C
Input Voltage (Transient, 1 second)	80 Volts	Storage Temperature	-65°C to +150°C
Output Power ¹	40 Watts	Lead Solder Temperature (10 seconds)	270°C
Power Dissipation (Full Load, T _{CASE} = +125°C)	13 Watts	Weight (Maximum) (Un-Flanged / Flanged)	(52 / 55) Grams
ESD Rating per MIL-PRF-38534	3A		

Parameter	Conditions	DVTR2815S			DVTR2818S			Units
		Min	Typ	Max	Min	Typ	Max	
STATIC								
INPUT Voltage ⁴	Continuous	15	28	50	15	28	50	V
	Transient, 1 sec	-	-	80	-	-	80	V
Current	Inhibited	-	4	6	-	4	6	mA
	No Load	-	60	90	-	60	90	mA
Ripple Current	Full Load, 20Hz to 10MHz	-	30	50	-	30	50	mA _{p-p}
Inhibit Pin Input ⁴		0	-	1.5	0	-	1.5	V
Inhibit Pin Open Circuit Voltage ⁴		9.0	11.0	13.0	9.0	11.0	13.0	V
UVLO Turn On		12.0	-	14.8	12.0	-	14.8	V
UVLO Turn Off ⁴		11.0	-	14.5	11.0	-	14.5	V
OUTPUT Voltage	V _{OUT} T _{CASE} = 25°C	14.85	15	15.15	17.82	18	18.18	V
	V _{OUT} T _{CASE} = -55°C to +125°C	14.625	15	15.375	17.55	18	18.45	V
Power ³		0	-	40	0	-	40	W
Current ³	V _{OUT} 0	0	-	2.67	0	-	2.22	A
Ripple Voltage	V _{OUT} Full Load, 20Hz to 10MHz	-	20	50	-	20	50	mV _{p-p}
Line Regulation	V _{OUT} V _{IN} = 15V to 50V	-	2	20	-	2	20	mV
Load Regulation	V _{OUT} No Load to Full Load	-	10	50	-	10	50	mV
EFFICIENCY		77	84	-	77	84	-	%
LOAD FAULT POWER DISSIPATION ⁴	Overload	-	-	14	-	-	14	W
	Short Circuit	-	-	14	-	-	14	W
CAPACITIVE LOAD ⁴		-	-	500	-	-	500	μF
SWITCHING FREQUENCY		400	475	550	400	475	550	kHz
SYNC FREQUENCY RANGE	V _H - V _L = 5V, DC = 20-80%	500	-	600	500	-	600	kHz
ISOLATION	500 V _{DC}	100	-	-	100	-	-	MΩ
MTBF (MIL-HDBK-217F)	AIF @ T _C = 55°C	-	413	-	-	413	-	kHrs
DYNAMIC								
Load Step Output Transient	V _{OUT} Half Load to Full Load	-	500	700	-	450	700	mV _{PK}
Load Step Recovery ²		-	150	500	-	200	400	μSec
Line Step Output Transient ⁴	V _{OUT} V _{IN} = 16V to 40V	-	500	900	-	1000	1600	mV _{PK}
Line Step Recovery ^{2, 4}	P _{OUT} = 30W	-	300	500	-	350	550	μSec
Turn On Delay	V _{OUT} V _{IN} = 0V to 28V	-	10	20	-	10	20	mSec
Turn On Overshoot		-	0	50	-	0	50	mV _{PK}

Notes: 1. Dependant on output voltage. 2. Time for output voltage to settle within 1% of its nominal value.
3. Derate linearly to 0 at 135°C. 4. Verified by qualification testing.

SPECIFICATIONS (T_{CASE} = -55°C to +125°C, V_{IN} = +28V ± 5%, Full Load, Unless Otherwise Specified)

ABSOLUTE MAXIMUM RATINGS

Input Voltage (Continuous)	50 V _{DC}	Junction Temperature Rise to Case	+15°C
Input Voltage (Transient, 1 second)	80 Volts	Storage Temperature	-65°C to +150°C
Output Power ¹	40 Watts	Lead Solder Temperature (10 seconds)	270°C
Power Dissipation (Full Load, T _{CASE} = +125°C)	13 Watts	Weight (Maximum) (Un-Flanged / Flanged)	(52 / 55) Grams
ESD Rating per MIL-PRF-38534	3A		

Parameter	Conditions	DVTR2828S			Units
		Min	Typ	Max	
STATIC					
INPUT Voltage ⁴	Continuous	15	28	50	V
	Transient, 1 sec	-	-	80	V
Current	Inhibited	-	4	6	mA
	No Load	-	60	90	mA
Ripple Current	Full Load, 20Hz to 10MHz	-	30	50	mA _{p-p}
Inhibit Pin Input ⁴		0	-	1.5	V
Inhibit Pin Open Circuit Voltage ⁴		9.0	11.0	13.0	V
UVLO Turn On		12.0	-	14.8	V
UVLO Turn Off ⁴		11.0	-	14.5	V
OUTPUT Voltage	V _{OUT} T _{CASE} = 25°C	27.72	28	28.28	V
	V _{OUT} T _{CASE} = -55°C to +125°C	27.30	28	28.70	V
Power ³		0	-	40	W
Current ³	V _{OUT}	0	-	1.43	A
Ripple Voltage	V _{OUT} Full Load, 20Hz to 10MHz	-	30	150	mV _{p-p}
Line Regulation	V _{OUT} V _{IN} = 15V to 50V	-	2	150	mV
Load Regulation	V _{OUT} No Load to Full Load	-	20	150	mV
EFFICIENCY		79	84	-	%
LOAD FAULT POWER DISSIPATION ⁴	Overload	-	-	14	W
	Short Circuit	-	-	14	W
CAPACITIVE LOAD ⁴		-	-	500	μF
SWITCHING FREQUENCY		400	450	550	kHz
SYNC FREQUENCY RANGE	V _H - V _L = 5V, DC = 20-80%	500	-	600	kHz
ISOLATION	500 V _{DC}	100	-	-	MΩ
MTBF (MIL-HDBK-217F)	AIF @ T _C = 55°C	-	413	-	kHrs
DYNAMIC					
Load Step Output Transient	V _{OUT} Half Load to Full Load	-	850	1200	mV _{PK}
Load Step Recovery ²			250	400	μSec
Line Step Output Transient ⁴	V _{OUT} V _{IN} = 16V to 40V	-	1500	2800	mV _{PK}
Line Step Recovery ^{2, 4}			350	600	μSec
Turn On Delay	V _{OUT} V _{IN} = 0V to 28V	-	10	20	mSec
Turn On Overshoot		-	0	50	mV _{PK}

Notes: 1. Dependant on output voltage. 2. Time for output voltage to settle within 1% of its nominal value.
3. Derate linearly to 0 at 135°C. 4. Verified by qualification testing.

BLOCK DIAGRAM

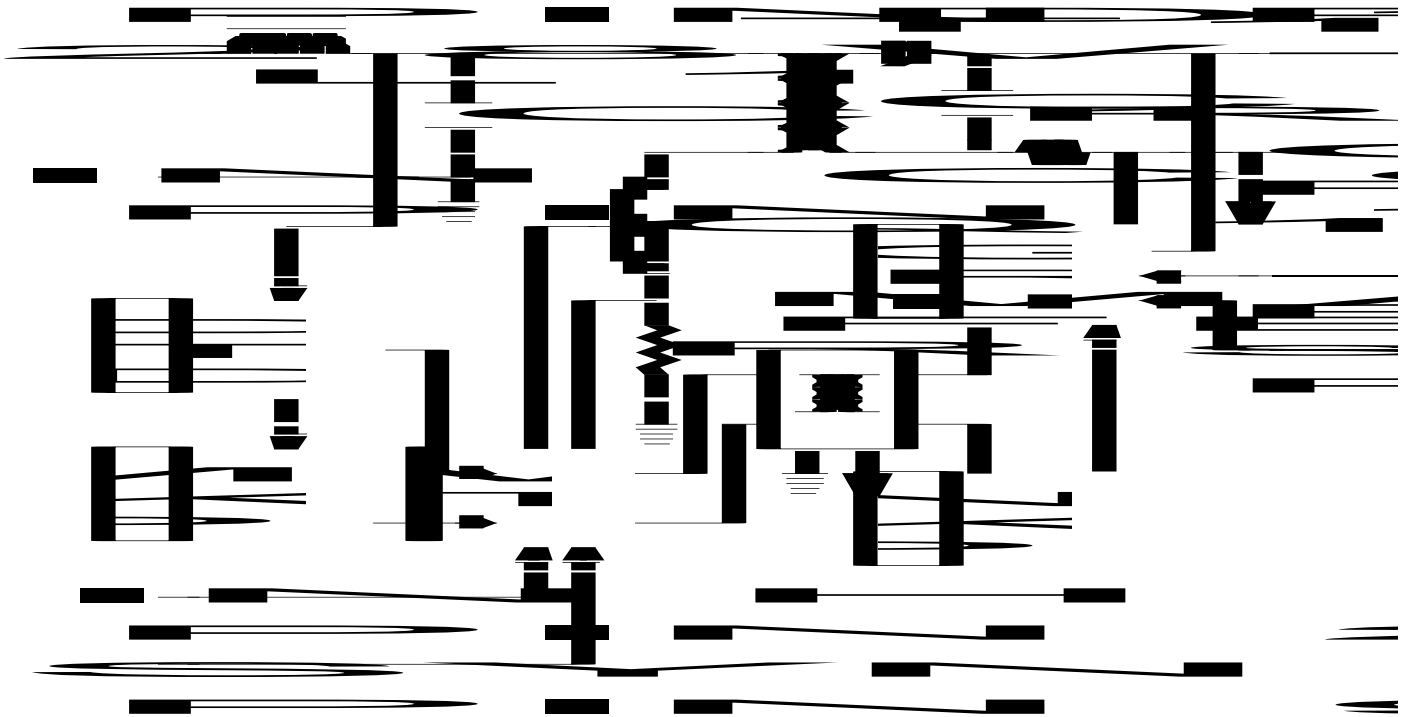

Figure 2

CONNECTION DIAGRAM



Figure 3

INHIBIT DRIVE CONNECTION DIAGRAMS

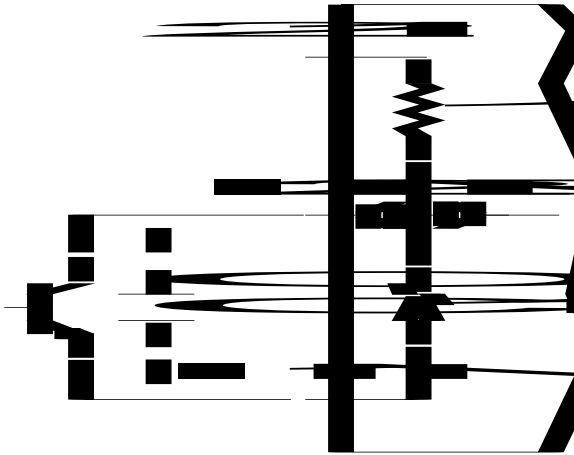

Figure 4 – Internal Inhibit Circuit and Recommended Drive
(Shown with optional capacitor for turn-on delay)

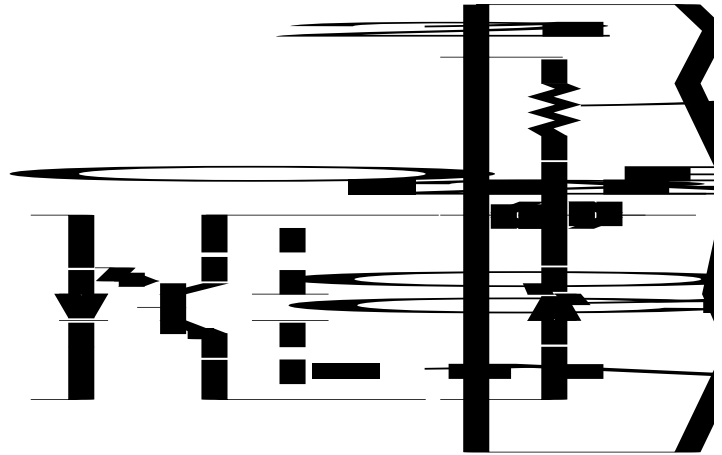

Figure 5 – Isolated Inhibit Drive
(Shown with optional capacitor for turn-on delay)

EMI FILTER HOOKUP DIAGRAM

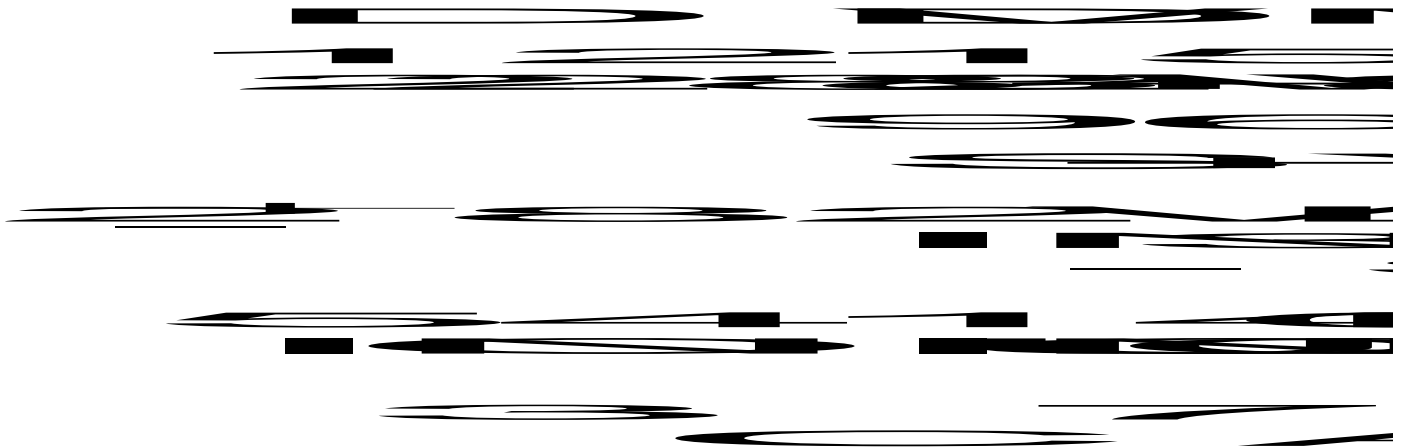
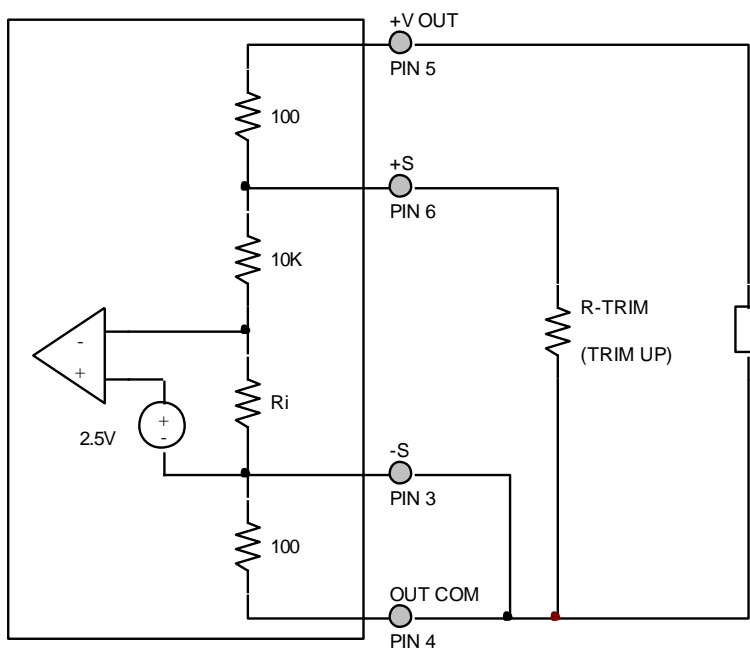

Figure 6 – Converter with EMI Filter

OUTPUT VOLTAGE TRIM



The output voltage can be trimmed up by connecting a resistor between the +S pin (PIN 6) and the OUT COM pin (PIN 4). The maximum trim range is +10%. The appropriate resistor values versus the output voltage are given in the trim table below. The -S pin should be connected to the OUT COM pin.

Figure 7 – Output Voltage Trim

DVTR282R5S		DVTR283R3S		DVTR2805S		DVTR285R2S		DVTR2807S	
+V _{OUT} (V)	R _{TRIM} (Ω)	+V _{OUT} (V)	R _{TRIM} (Ω)	+V _{OUT} (V)	R _{TRIM} (Ω)	+V _{OUT} (V)	R _{TRIM} (Ω)	+V _{OUT} (V)	R _{TRIM} (Ω)
2.75	1.05k	3.60	1.13k	5.50	1.05k	5.70	1.09k	7.70	1.07k
2.70	1.33k	3.55	1.36k	5.45	1.18k	5.65	1.22k	7.65	1.16k
2.65	1.82k	3.50	1.72k	5.40	1.33k	5.60	1.39k	7.60	1.26k
2.60	2.86k	3.45	2.32k	5.35	1.54k	5.55	1.60k	7.55	1.39k
2.55	6.67k	3.40	3.59k	5.30	1.82k	5.50	1.89k	7.50	1.54k
2.50	-	3.35	7.87k	5.25	2.22k	5.45	2.31k	7.45	1.73k
		3.30	-	5.20	2.86k	5.40	2.97k	7.40	1.97k
				5.15	4.00k	5.35	4.16k	7.35	2.29k
				5.10	6.67k	5.30	6.93k	7.30	2.74k
				5.05	20.0k	5.25	20.8k	7.25	3.41k
				5.00	-	5.20	-	7.20	4.51k
								7.15	6.64k
								7.10	12.6k
								7.05	131k
								7.00	-

(Continued on next page)

OUTPUT VOLTAGE TRIM

DVTR2808S		DVTR289R5S		DVTR2812S		DVTR2815S	
+V _{OUT} (V)	R _{TRIM} (Ω)	+V _{OUT} (V)	R _{TRIM} (Ω)	+V _{OUT} (V)	R _{TRIM} (Ω)	+V _{OUT} (V)	R _{TRIM} (Ω)
8.8	1.07k	10.5	1.02k	13.2	1.09k	16.50	1.09k
8.7	1.24k	10.4	1.15k	13.1	1.19k	16.40	1.18k
8.6	1.47k	10.3	1.31k	13.0	1.33k	16.30	1.28k
8.5	1.80k	10.2	1.52k	12.9	1.49k	16.20	1.40k
8.4	2.32k	10.1	1.8k	12.8	1.70k	16.10	1.54k
8.3	3.27k	10	2.22k	12.7	1.98k	16.00	1.71k
8.2	5.52k	9.9	2.9k	12.6	2.38k	15.90	1.94k
8.1	17.8k	9.8	4.18k	12.5	2.96k	15.80	2.22k
8.0	-	9.7	7.47k	12.4	3.94k	15.70	2.61k
		9.6	34.97k	12.3	5.86k	15.60	3.16k
		9.5	-	12.2	11.4k	15.50	4.00k
				12.1	242k	15.40	5.46k
				12.0	-	15.30	8.57k
						15.20	20.0k
						15.10	Note 1
						15.00	-

DVTR2818S		DVTR2828S	
+V _{OUT} (V)	R _{TRIM} (Ω)	+V _{OUT} (V)	R _{TRIM} (Ω)
19.8	1.09k	30.8	1.10k
19.6	1.24k	30.6	1.19k
19.4	1.43k	30.4	1.30k
19.2	1.70k	30.2	1.44k
19.0	2.10k	30.0	1.60k
18.8	2.74k	29.8	1.81k
18.6	3.94k	29.6	2.07k
18.4	7.00k	29.4	2.44k
18.2	31.5k	29.2	2.95k
18.0	-	29.0	3.73k
		28.8	5.09k
		28.6	8.00k
		28.4	18.7k
		28.2	Note 1
		28.0	-

Notes: 1. Connect R-TRIM = 400Ω from +V_{OUT} (PIN 5) to +S (PIN 6).

EFFICIENCY PERFORMANCE CURVES (T_{CASE} = 25°C, Full Load, Unless Otherwise Specified)

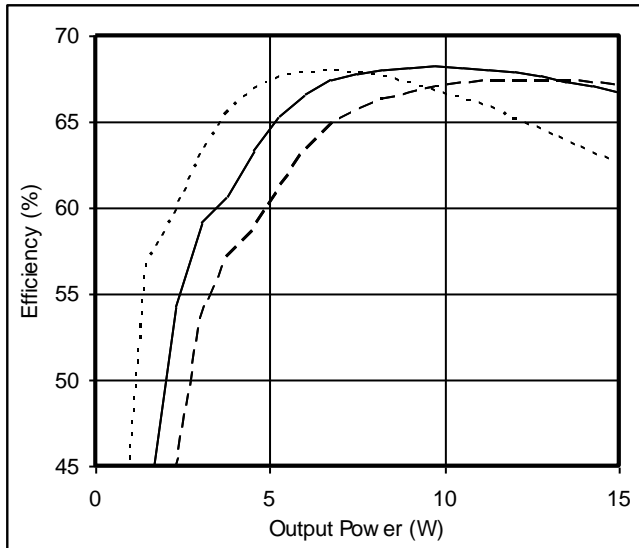
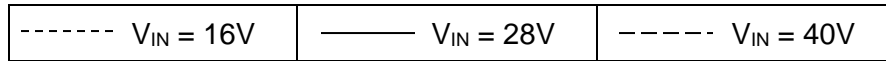

Figure 8 – DVTR282R5S
Efficiency (%) vs. Output Power (W)

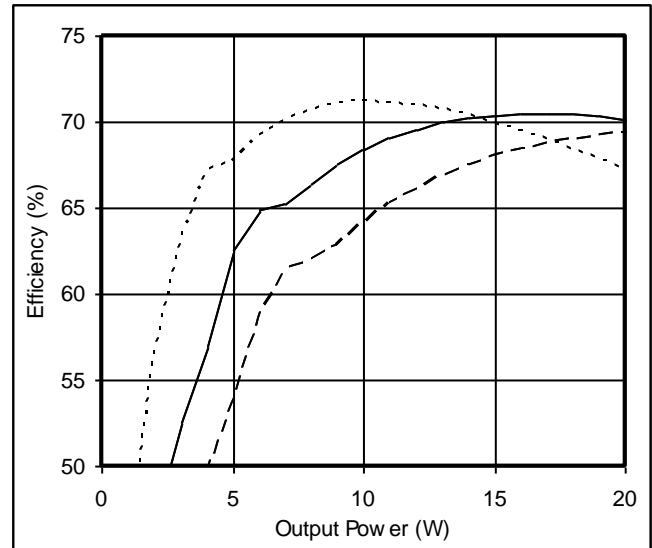

Figure 9 – DVTR283R3S
Efficiency (%) vs. Output Power (W)

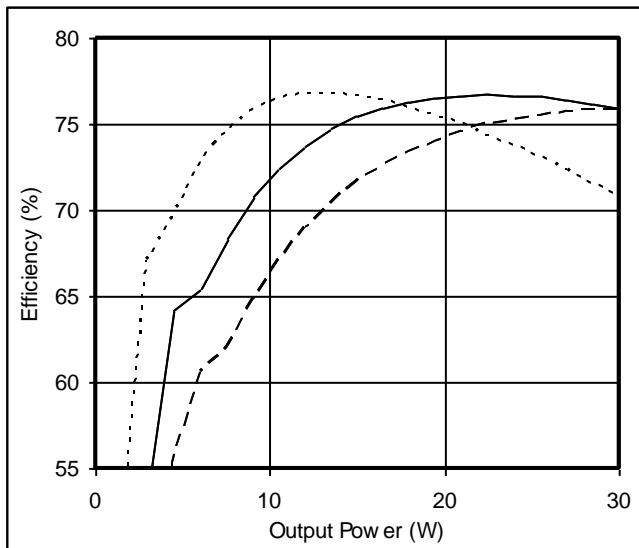

Figure 10 – DVTR2805S / DVTR285R2S
Efficiency (%) vs. Output Power (W)

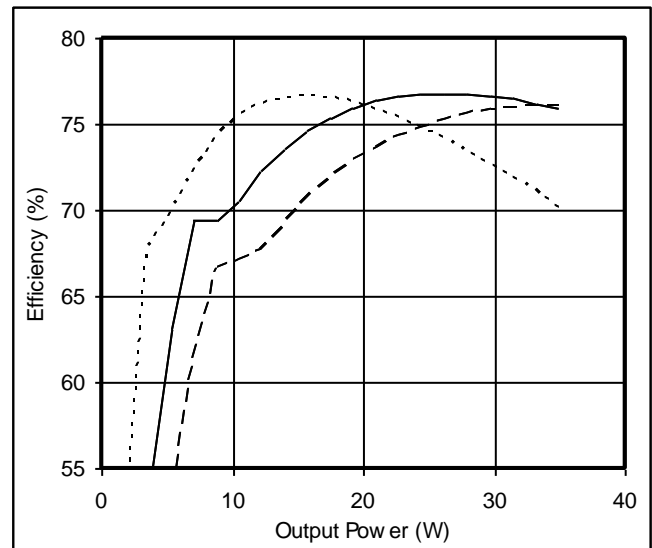

Figure 11 – DVTR2807S
Efficiency (%) vs. Output Power (W)

EFFICIENCY PERFORMANCE CURVES (T_{CASE} = 25°C, Full Load, Unless Otherwise Specified)

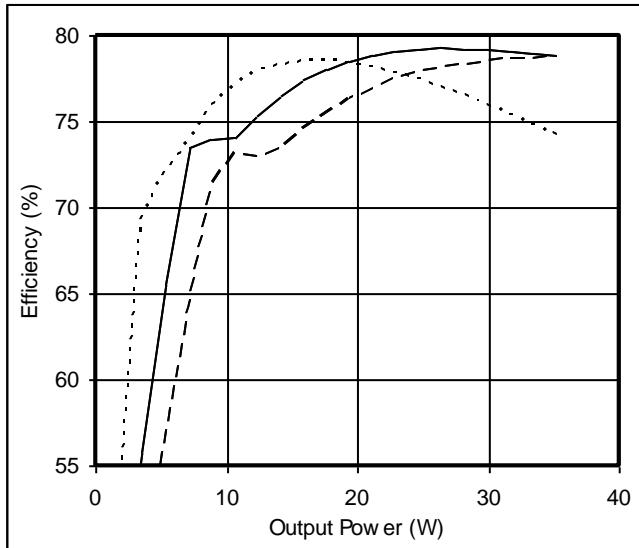

Figure 12 – DVTR2808S
Efficiency (%) vs. Output Power (W)

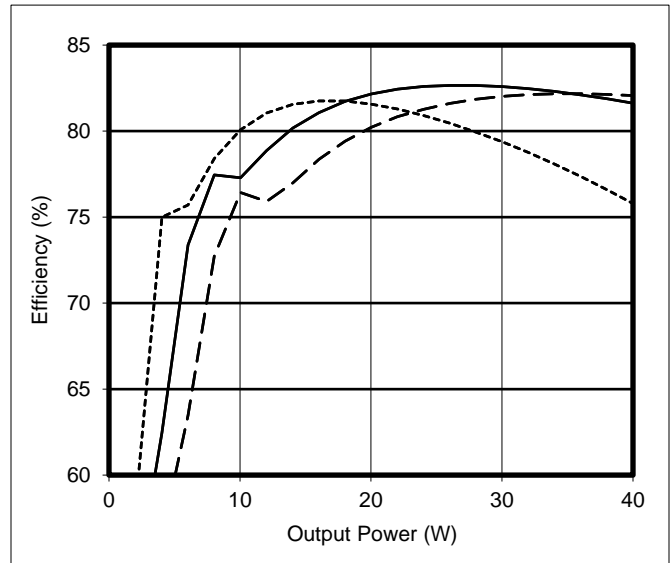

Figure 13 – DVTR289R5S
Efficiency (%) vs. Output Power (W)

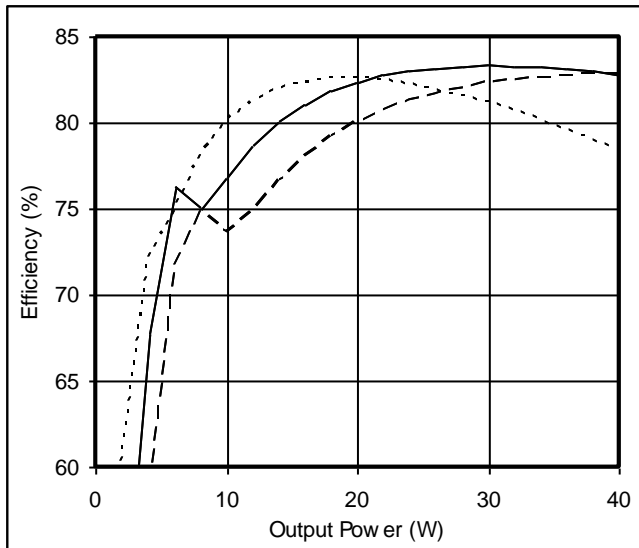

Figure 14 – DVTR2812S
Efficiency (%) vs. Output Power (W)

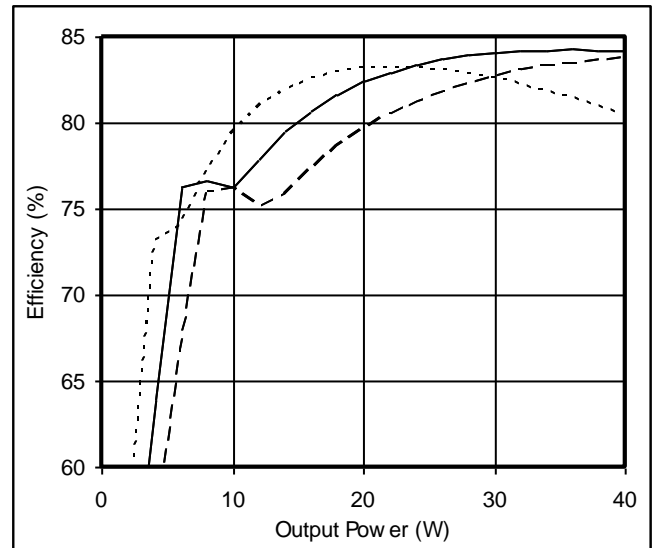

Figure 15 – DVTR2815S
Efficiency (%) vs. Output Power (W)

EFFICIENCY PERFORMANCE CURVES ($T_{CASE} = 25^{\circ}C$, Full Load, Unless Otherwise Specified)

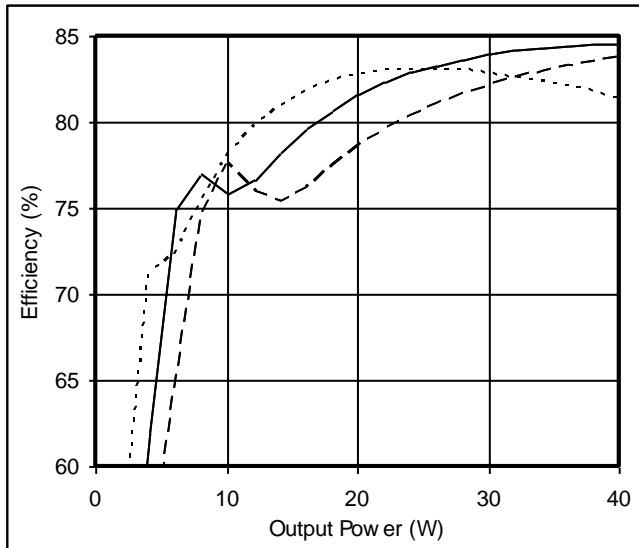

Figure 16 – DVTR2818S
Efficiency (%) vs. Output Power (W)

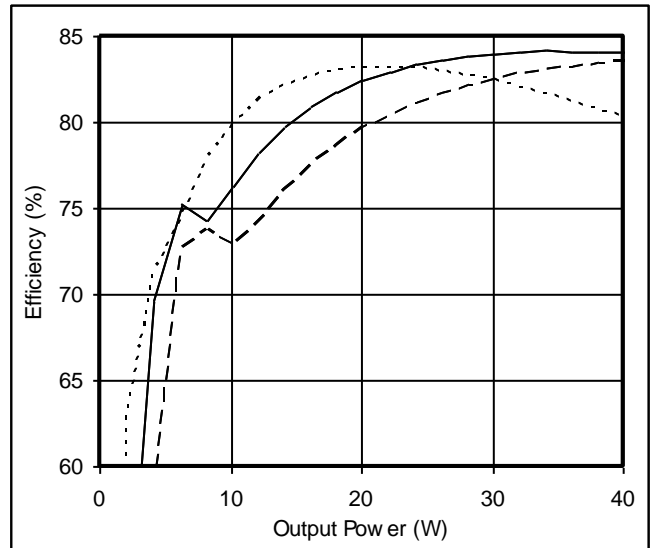

Figure 17 – DVTR2828S
Efficiency (%) vs. Output Power (W)

EMI PERFORMANCE CURVES

($T_{CASE} = 25^{\circ}C$, $V_{IN} = +28V \pm 5\%$, Full Load, Unless Otherwise Specified)

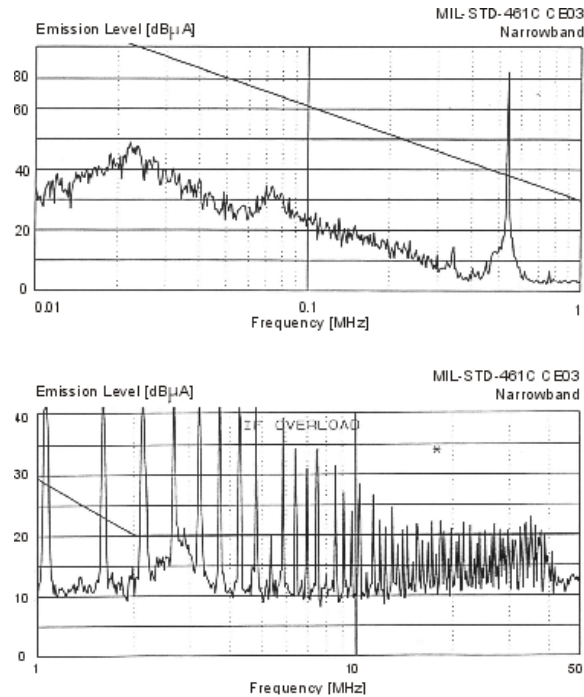

Figure 18 – DVTR2800S without EMI Filter

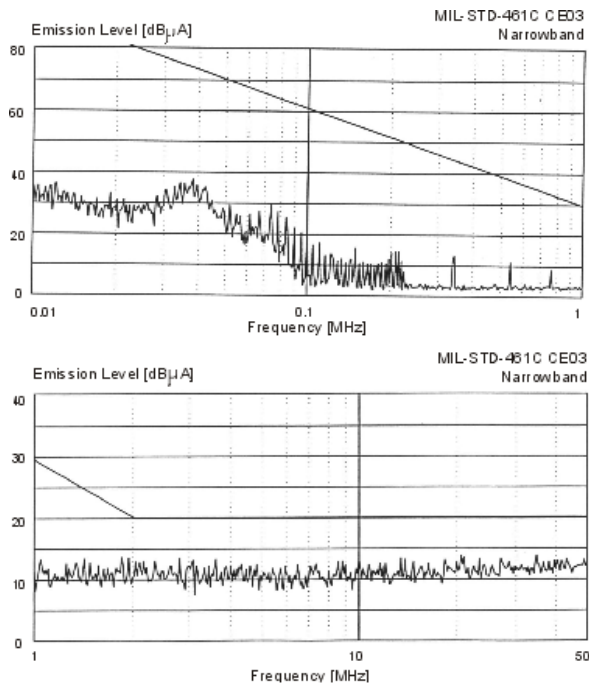
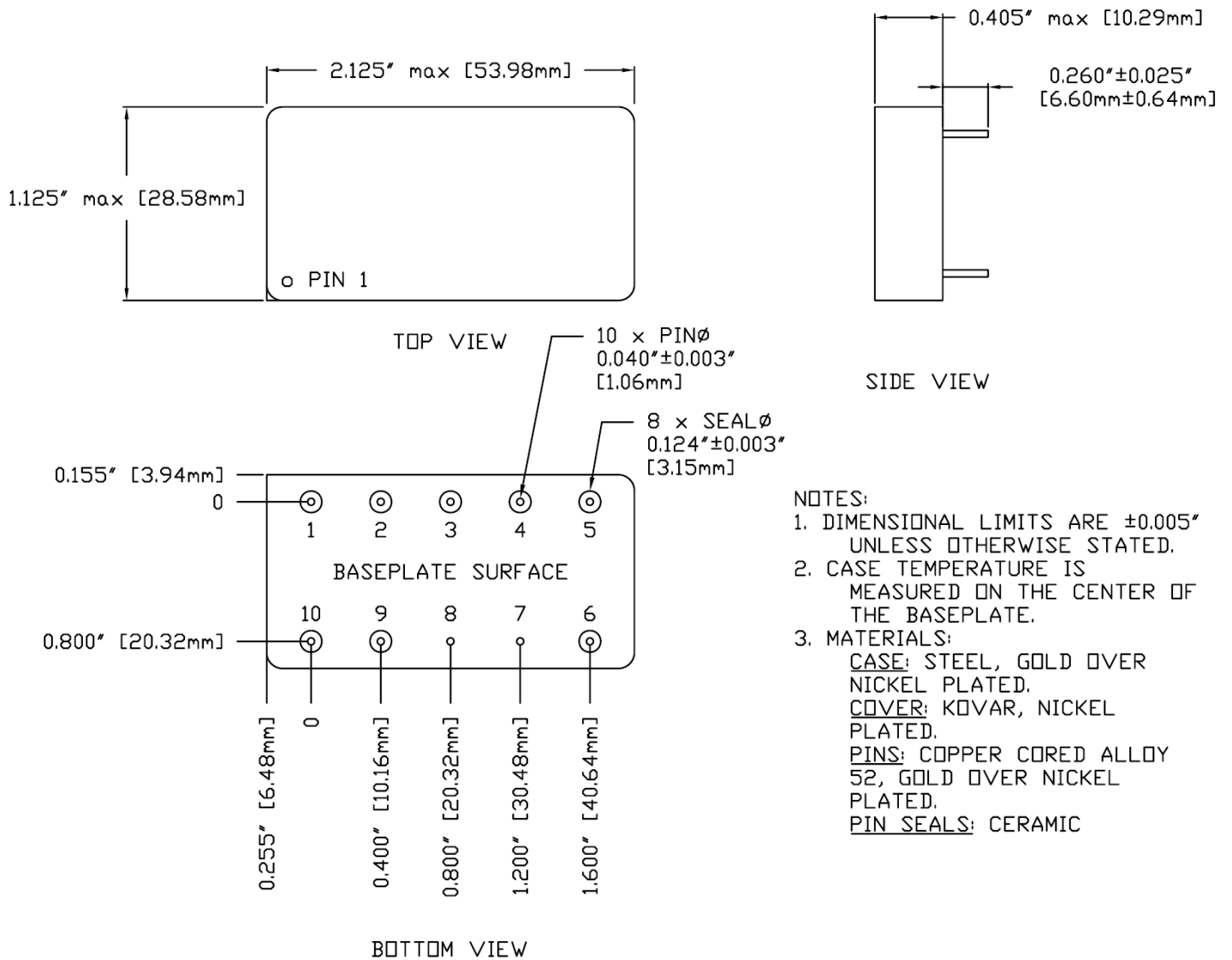

Figure 19 – DVTR2800S with EMI Filter

PACKAGE SPECIFICATIONS (NON-FLANGED, SEAM SEAL)



Pin	Function	Pin	Function
1	28V IN	6	+S
2	INHIBIT	7	CASE
3	-S	8	CASE
4	OUT COM	9	SYNC
5	+V OUT	10	IN COM

Figure 20 – Non-Flanged, Seam Seal Package and Pinout

PACKAGE SPECIFICATIONS (FLANGED, SEAM SEAL)

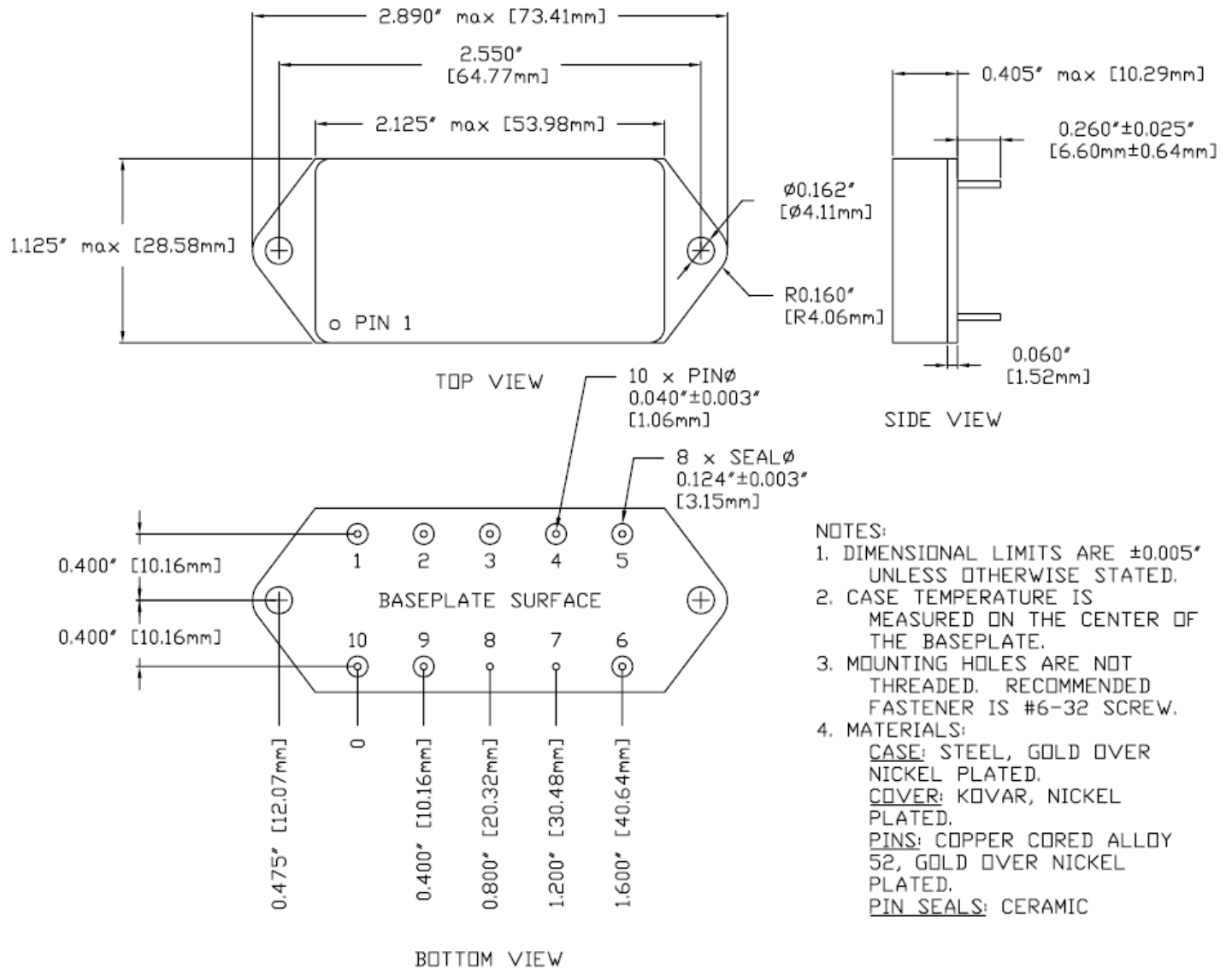

Pin	Function	Pin	Function
1	28V IN	6	+S
2	INHIBIT	7	CASE
3	-S	8	CASE
4	OUT COM	9	SYNC
5	+V OUT	10	IN COM

Figure 21 – Flanged, Seam Seal Package and Pinout

PACKAGE PIN DESCRIPTION

Pin	Function	Description
1	28V IN	Positive Input Voltage Connection
2	INHIBIT	Logic Low = Disabled Output. Connecting the inhibit pin to input common causes converter shutdown. Logic High = Enabled Output. Unconnected or open collector TTL.
3	-S	Return Sense
4	OUT COM	Output Common Connection
5	+V OUT	Positive Output Voltage Connection
6	+S	Positive Sense
7	CASE	Case Connection
8	CASE	Case Connection
9	SYNC	Synchronization Signal
10	IN COM	Input Common Connection

ENVIRONMENTAL SCREENING (100% Tested Per MIL-STD-883 as referenced to MIL-PRF-38534)

Test	MIL-STD-883 Test Method, Condition	No Suffix (Standard) Non-QML ⑤	/ES (Extended) Non-QML ⑤	/H (Class H)	/K (Class K)
Non-Destructive Bond Pull	TM2023	• ④	• ④	• ④	•
Internal Visual	TM2010, TM2017, TM2032 (MIL-STD-750, TM2072, TM2073)	•	•	•	•
Temperature Cycling	TM1010, Condition C -65°C to 150°C, Ambient			•	•
	TM1010, Condition B -55°C to 125°C, Ambient		•		
Constant Acceleration	TM2001, 3000g, Y1 Direction			•	•
	TM2001, 500g, Y1 Direction		•		
PIND ⑦	TM2020, Condition A				•
Pre Burn-In Electrical	25°C				•
Burn-In	TM1015, 320 hrs, 125°C, Case Typ				•
	TM1015, 160 hrs, 125°C, Case Typ			•	
	96 hrs, 125°C, Case Typ		•		
	24 hrs, 125°C, Case Typ	•			
Final Electrical	MIL-PRF-38534, Group A Subgroups 1-6 -55°C, 25°C, 125°C ③			•	•
	MIL-PRF-38534, Group A Subgroups 1 and 4 25°C	•	•		
Hermeticity (Seal)	TM1014, Fine Leak, Condition A2 or B1		•	•	•
	TM1014, Gross Leak, Condition C or B2		•	•	•
	Gross Leak, Dip (1 x 10 ⁻³)	•			
Radiography ⑧	TM2012				•
External Visual	TM2009	•	•	•	•

Notes:

- ① Contact Sales for more information concerning additional environmental screening and testing options desired.
- ② VPT Inc. reserves the right to ship higher screened or SMD products to meet lower screened orders at our sole discretion unless specifically forbidden by customer contract.
- ③ 100% R&R testing with all test data included in product shipment.
- ④ Not required per MIL-PRF-38534. Test is performed for additional product quality assurance.
- ⑤ Non-QML products may not meet all requirements of MIL-PRF-38534.
- ⑥ Note intentionally not used.
- ⑦ PIND test Certificate of Compliance included in product shipment.
- ⑧ Radiographic test Certificate of Compliance and film(s) or data CD included in product shipment.

ORDERING INFORMATION

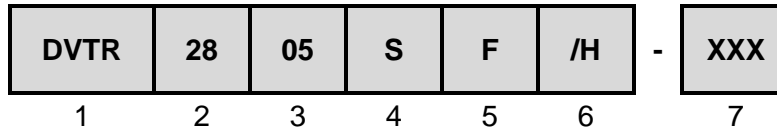

(1) Product Series	(2) Nominal Input Voltage		(3) Output Voltage		(4) Number of Outputs	
DVTR	28	28 Volts	2R5 3R3 05 5R2 07 08 9R5 12 15 18 28	2.5 Volts 3.3 Volts 5 Volts 5.2 Volts 7 Volts 8 Volts 9.5 Volts 12 Volts 15 Volts 18 Volts 28 Volts	S	Single

(5) Package Option		(6) Screening Code ¹		(7) Additional Screening Code
None F	Non-Flanged Flanged	None /ES /H /K	Standard Extended Class H Class K	Contact Sales

Notes: 1. VPT Inc. reserves the right to ship higher screened or SMD products to meet lower screened orders at our sole discretion unless specifically forbidden by customer contract.

Please contact your sales representative or the VPT Inc. Sales Department for more information concerning additional environmental screening and testing, different input voltage, output voltage, power requirement, source inspection, and/or special element evaluation for space or other higher quality applications.

SMD (STANDARD MICROCIRCUIT DRAWING) NUMBERS

Standard Microcircuit Drawing (SMD)	DVTR2800S Series Similar Part Number
5962-1122401HXC 5962-1122401HXA 5962-1122401HYC 5962-1122401HYA 5962-1122401KXC 5962-1122401KXA 5962-1122401KYC 5962-1122401KYA	DVTR282R5S/H DVTR282R5S/H-E DVTR282R5SF/H DVTR282R5SF/H-E DVTR282R5S/K DVTR282R5S/K-E DVTR282R5SF/K DVTR282R5SF/K-E
5962-1122402HXC 5962-1122402HXA 5962-1122402HYC 5962-1122402HYA 5962-1122402KXC 5962-1122402KXA 5962-1122402KYC 5962-1122402KYA	DVTR283R3S/H DVTR283R3S/H-E DVTR283R3SF/H DVTR283R3SF/H-E DVTR283R3S/K DVTR283R3S/K-E DVTR283R3SF/K DVTR283R3SF/K-E
5962-1122403HXC 5962-1122403HXA 5962-1122403HYC 5962-1122403HYA 5962-1122403KXC 5962-1122403KXA 5962-1122403KYC 5962-1122403KYA	DVTR2805S/H DVTR2805S/H-E DVTR2805SF/H DVTR2805SF/H-E DVTR2805S/K DVTR2805S/K-E DVTR2805SF/K DVTR2805SF/K-E
5962-1122404HXC 5962-1122404HXA 5962-1122404HYC 5962-1122404HYA 5962-1122404KXC 5962-1122404KXA 5962-1122404KYC 5962-1122404KYA	DVTR285R2S/H DVTR285R2S/H-E DVTR285R2SF/H DVTR285R2SF/H-E DVTR285R2S/K DVTR285R2S/K-E DVTR285R2SF/K DVTR285R2SF/K-E

Standard Microcircuit Drawing (SMD)	DVTR2800S Series Similar Part Number
5962-1122405HXC 5962-1122405HXA 5962-1122405HYC 5962-1122405HYA 5962-1122405KXC 5962-1122405KXA 5962-1122405KYC 5962-1122405KYA	DVTR2812S/H DVTR2812S/H-E DVTR2812SF/H DVTR2812SF/H-E DVTR2812S/K DVTR2812S/K-E DVTR2812SF/K DVTR2812SF/K-E
5962-1122406HXC 5962-1122406HXA 5962-1122406HYC 5962-1122406HYA 5962-1122406KXC 5962-1122406KXA 5962-1122406KYC 5962-1122406KYA	DVTR2815S/H DVTR2815S/H-E DVTR2815SF/H DVTR2815SF/H-E DVTR2815S/K DVTR2815S/K-E DVTR2815SF/K DVTR2815SF/K-E
5962-1122407HXC 5962-1122407HXA 5962-1122407HYC 5962-1122407HYA 5962-1122407KXC 5962-1122407KXA 5962-1122407KYC 5962-1122407KYA	DVTR2828S/H DVTR2828S/H-E DVTR2828SF/H DVTR2828SF/H-E DVTR2828S/K DVTR2828S/K-E DVTR2828SF/K DVTR2828SF/K-E
5962-1122408HXC 5962-1122408HXA 5962-1122408HYC 5962-1122408HYA 5962-1122408KXC 5962-1122408KXA 5962-1122408KYC 5962-1122408KYA	DVTR289R5S/H DVTR289R5S/H-E DVTR289R5SF/H DVTR289R5SF/H-E DVTR289R5S/K DVTR289R5S/K-E DVTR289R5SF/K DVTR289R5SF/K-E

Standard Microcircuit Drawing (SMD)	DVTR2800S Series Similar Part Number
5962-1122409HXC	DVTR2808S/H
5962-1122409HXA	DVTR2808S/H-E
5962-1122409HYC	DVTR2808SF/H
5962-1122409HYA	DVTR2808SF/H-E
5962-1122409KXC	DVTR2808S/K
5962-1122409KXA	DVTR2808S/K-E
5962-1122409KYC	DVTR2808SF/K
5962-1122409KYA	DVTR2808SF/K-E
5962-1122410HXC	DVTR2818S/H
5962-1122410HXA	DVTR2818S/H-E
5962-1122410HYC	DVTR2818SF/H
5962-1122410HYA	DVTR2818SF/H-E
5962-1122410KXC	DVTR2818S/K
5962-1122410KXA	DVTR2818S/K-E
5962-1122410KYC	DVTR2818SF/K
5962-1122410KYA	DVTR2818SF/K-E

Do not use the DVTR2800S Series similar part number for SMD product acquisition. It is listed for reference only. For exact specifications for the SMD product, refer to the SMD drawing. SMDs can be downloaded from the DLA Land and Maritime (Previously known as DSCC) website at <https://landandmaritimeapps.dla.mil/programs/defaultapps.asp>. The SMD number listed above represents the Federal Stock Class, Device Type, Device Class Designator, Case Outline, Lead Finish and RHA Designator (where applicable). Please reference the SMD for other screening levels, lead finishes, and radiation levels. All SMD products are marked with a "Q" on the cover as specified by the QML certification mark requirement of MIL-PRF-38534.

CONTACT INFORMATION

To request a quotation or place orders please contact your sales representative or the VPT Inc. Sales Department at:

Phone: (425) 353-3010
Fax: (425) 353-4030
E-mail: vptsales@vptpower.com

All information contained in this datasheet is believed to be accurate, however, no responsibility is assumed for possible errors or omissions. The products or specifications contained herein are subject to change without notice.