

**Wire to Wire Connectors
AMP 250 Series Housing Lance Connectors**

Features

- Tab and receptacle contacts ensure positive electrical contact.
- The housing lance design makes connector assembling operations easier and faster.
- Standard and Interlock Types, each available in two styles, one for panel-mounting and the other for free-hanging applications.
- Both connectors use the same tab and receptacle contacts in common.
- Contacts accept AWG # 22-12(0.3-3.37mm²) wires with insulation diameters of 1.5-3.8mm.

AMP 250 Series Housing Lance Connectors are an improved, easy-to-handle tab and receptacle connector incorporating outstanding features of the AMP-FASTON* products which enjoy wide acceptance in the automotive industry.

One of the main features of these connectors is that a retention lance mechanism is built into the housing. Consequently, there is no possibility of contacts being tangled with each other, making connector assembling operations much easier and faster.

The housing lance connectors are offered in two types, Standard Type and smaller Interlock Type with anti-stubbing feature.

They are available in two styles, one for panel-mounting and the other for free-hanging applications.



Panel-mounting connectors are available in cap housing only and mate with plug housings of the same positions for free-hanging applications.

Both Standard and Interlock connectors use the same tab and receptacle contacts in common.

The plug housing also features an integral double-lock to hold contacts loaded after wire termination more positively, providing an effective protection against contact damage by rocking motion at mating & unmating durability and dependability.

Sizes currently available are as follows:

● **Standard**

For panel-mounting:
2, 3 pos.

For free-hanging: 1, 2, 3,
4, 6, 8, 10 pos.

● **Interlock Type**

For panel-mounting: 3 pos.

For free-hanging: 1, 2, 3,
4, 5, 7, 9 pos.

Tab and receptacle contacts accept AWG # 22-12 (0.3-3.37mm²) wire with maximum insulation diameters of 1.5-3.8mm.

For wire termination, contacts are in strip form to be applied by high-speed automatic terminating machines.

Performance Data

Insulation resistance:
100MΩ min.

Overall resistance:
10mΩ max.

Withstanding voltage:
1kV AC/1 min.

Contact retention force:
6kg min.

Contact insertion force:
0.8~3.0kg

Contact extraction force:
0.8~3.0kg

Operating temperature:
+105°C Max.

Product specification:
108-5153(Standard Type)
108-5169(Interlock Type)

Application specification:
114-5052

**Wire to Wire Connectors
AMP 250 Series Housing Lance Connectors**

**Receptacle Contact
(For Plug)**

Material: Brass(0.32mm thick)

**Tab Contact
(For Cap)**

Material: Brass(0.4mm thick)

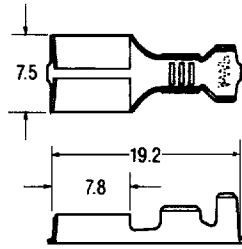

Receptacle

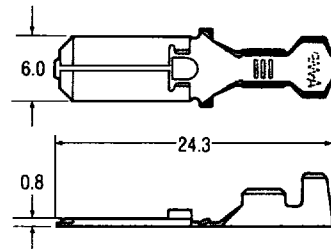

Tab

Wire Range		Wire Ins. Diameter	Finish	Contact Part Number (s.t.)	
AWG	mm ²			Receptacle	Tab
22-20	0.3~0.5	1.5~2.2	—	170384-1	170349-1
				2-170384-1 ⁽²⁾	
			Tin	3-170384-1 ⁽¹⁾	170349-2*
				170384-2	
20-14	0.5~2.27	2.2~3.4	—	3-170384-2 ⁽¹⁾	170340-1
				4-170384-2 ⁽⁴⁾	
14-12	2.0~3.37	2.9~3.8	—	170032-2	170340-3*
				170032-5	
			Tin	170258-1	170341-1
				2-170258-1 ⁽³⁾	
Tin	3-170258-1 ⁽¹⁾	170341-3*			
	170258-2				
				4-170258-2 ⁽⁴⁾	

⁽¹⁾ Reverse Reel
⁽²⁾ 20M Standard Reel for AMPOMATOR Machine
⁽³⁾ 15M Standard Reel for AMPOMATOR Machine
⁽⁴⁾ Inverted Reel
 * Pre-tin

5

Wire to Wire Connectors

AMP 250 Series Housing Lance Connectors

Standard Type Cap Housing For Panel Mount

Material: 66 Nylon
(See chart for color)

Applicable Contact Part No.:
For Cap **170349**
170340
170341

2 Positions

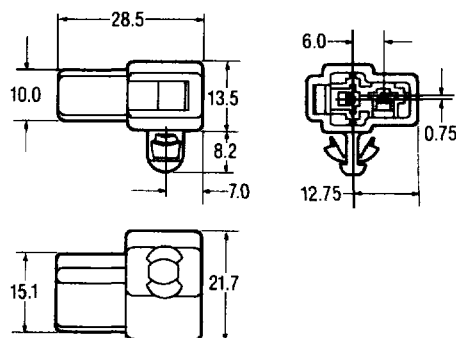

No. of Pos.	Cap Housing		Mating Plug Housing
	Part No.	Color	
2	172383-1	Natural	172130
	172383-2	Black	
	172383-3	Brown	
	172383-4	Green	
	172383-5	Blue	
	172383-6	Gray	
	—	Yellow	
	172383-8	Orange	
	172383-9	Red	
	1-172383-0	Pink	

3 Positions

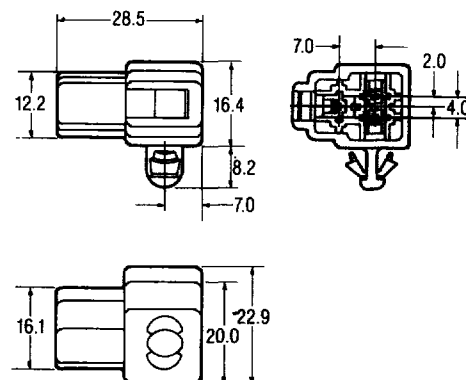

No. of Pos.	Cap Housing		Mating Plug Housing
	Part No.	Color	
3	172384-1	Natural	172132
	172384-2	Black	
	172384-3	Brown	
	172384-4	Green	
	—	Blue	
	172384-6	Gray	
	172384-7	Yellow	
	172384-8	Orange	

Standard Type Housing For Free Hanging

Material: 66 Nylon

Applicable Contact Part No.:
For Cap **170349**
170340
170341
For Plug **170384**
170032
170258

Note: See next page for dimensions, part nos. and housing colors.

Cap

1 Position

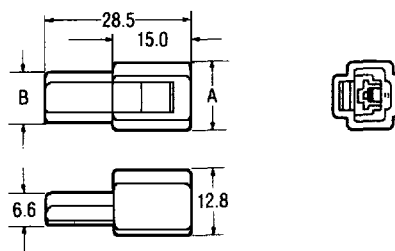

2 Positions

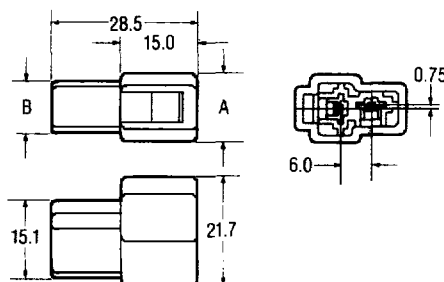

Plug

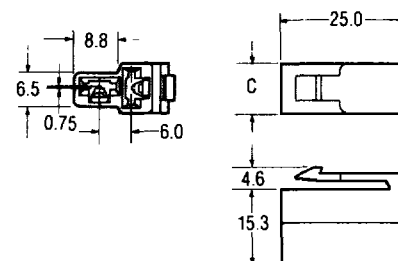
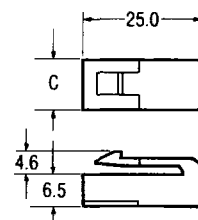

**Wire to Wire Connectors
AMP 250 Series Housing Lance Connectors**

**Standard Type
Housing
For Free Hanging**

Material: 66 Nylon

Applicable Contact Part No.:

For Cap 170349

170340

170341

For Plug 170384

170032

170258

3 Positions

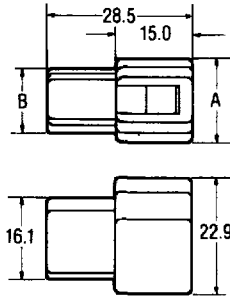

Cap

Plug

4,6,8 Positions

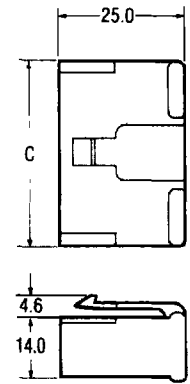
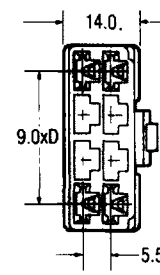
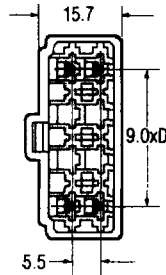
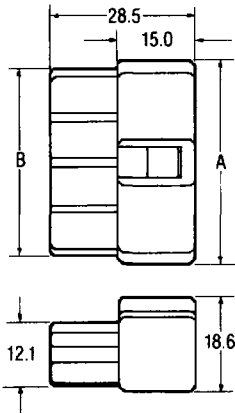

10 Positions

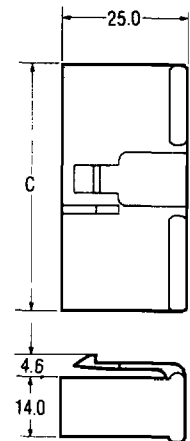
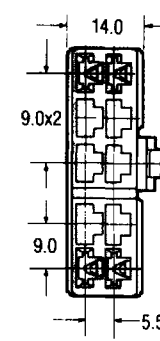
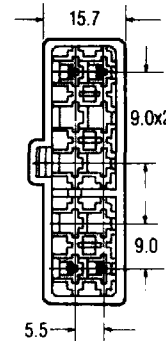
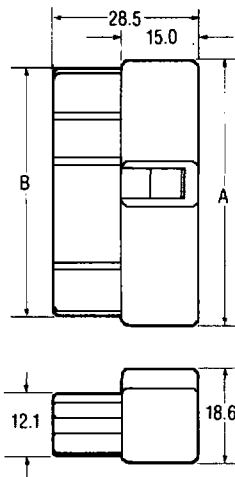

Suffix No. (□)	Housing Color
-1	Natural
-2	Black
-3	Brown
-4	Green
-5	Blue
-6	Gray
-7	Yellow
-8	Orange
-9	Red

No. of Pos.	Dimensions				Housing Part No.	
	A	B	C	D	Cap	Plug
1	13.5	10.0	10.0	—	172127-□	172128-□
2	13.5	10.0	10.0	—	172129-□	172130-□
3	16.4	12.2	13.0	—	172131-□	172132-□
4	22.5	19.5	19.0	1	172133-□	172134-□
6	31.5	28.0	28.0	2	171897-□	171898-□
8	40.5	37.0	37.0	3	172135-□	172136-□
10	52.4	49.0	49.0	—	172137-□	172138-□

Note: Number in □ varies by housing color. (refer to table, left)

**Wire to Wire Connectors
AMP 250 Series Housing Lance Connectors**

**Inter-lock Type
Cap Housing
For Panel Mount**

Material: 66 Nylon

**Applicable Contact
Part Nos.:** 170349
170340
170341

3 Positions

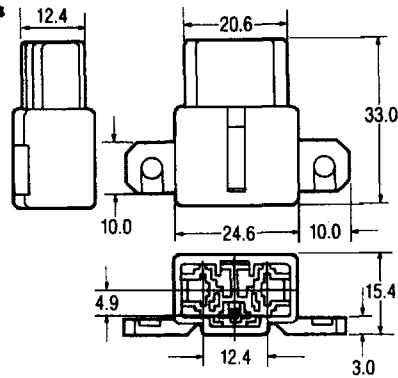

No. of Pos.	Cap Housing		Mating Plug Housing
	Part No.	Color	
3	172387-1	Natural	172220-□
	-	Black	
	-	Brown	
	-	Green	
	-	Blue	
	-	Grey	
	-	Yellow	

**Inter-lock Type
Housing
For Free Hanging**

Material: 66 Nylon

Applicable Contact Part No.:
For Cap 170349
170340
170341
For Plug 170384
170032
170258

Note: See next page for housing part number and color.

Cap

Plug

1 Position

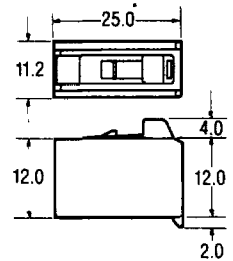
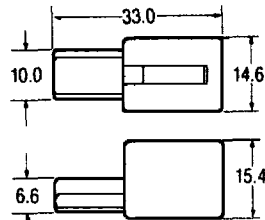

2 Positions

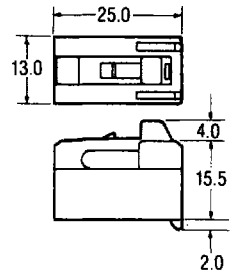
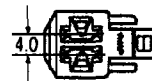
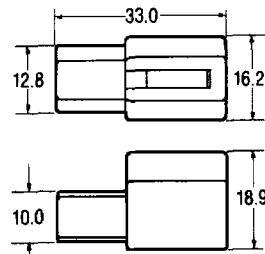

3 Positions

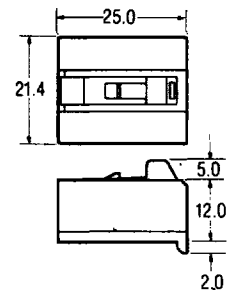
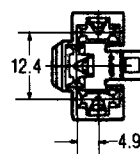
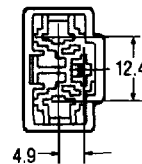
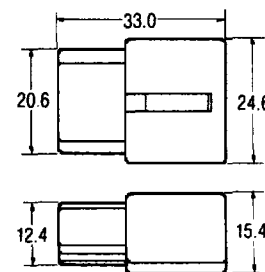

4 Positions

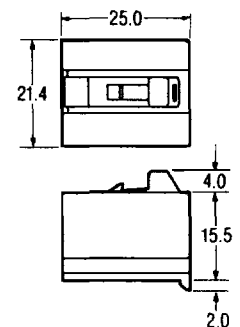
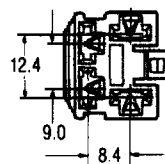
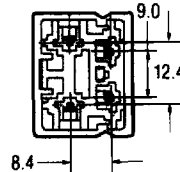
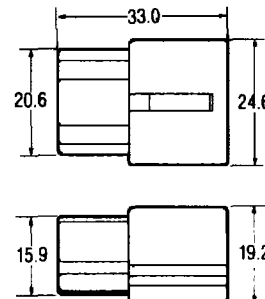

Wire to Wire Connectors AMP 250 Series Housing Lance Connectors

Inter-lock Type Housings For Free Hanging

Material: 66 Nylon

Applicable Contact Part No.:

For Cap: 170349

170340

170341

For Plug: 170384

170032

170258

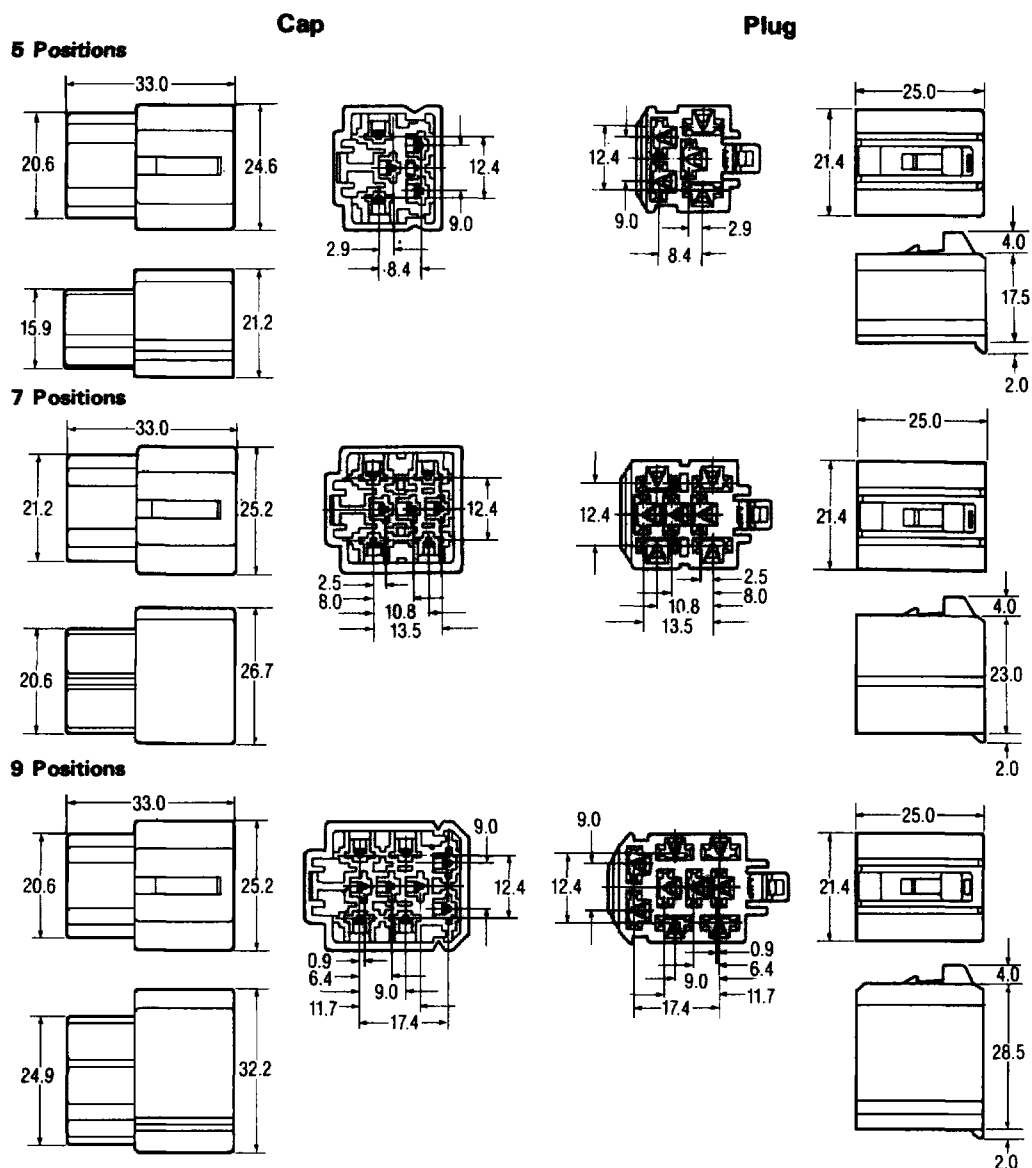

Suffix No. (□)	Housing Color
-1	Natural
-2	Black
-3	Brown
-4	Green
-5	Blue
-6	Gray
-7	Yellow

No. of Pos.	Housing Part Number	
	Cap	Plug
1	172215-□	172216-□
2	172217-□	172218-□
3	172219-□	172220-□
4	172221-□	172222-□
5	172223-□	172224-□
7	172225-□	172226-□
9	172227-□	172228-□

Note: Number in □ varies by housing color. (refer to table, left)

5