

FEATURES

- **LOW COST PLASTIC SURFACE MOUNT PACKAGE**
Available on Tape and Reel
- **USABLE TO 2.7 GHz:**
Fixed Wireless Access, ISM, WLL, MMDS, IMT-2000, PCS
- **HIGH OUTPUT POWER:**
35 dBm TYP
- **HIGH LINEAR GAIN:**
10 dB TYP at 1.9 GHz
- **LOW THERMAL RESISTANCE:**
5 C/W

DESCRIPTION

The NE6500379A is a 3 W GaAs MESFET designed for medium power Fixed Wireless Access, ISM, WLL, PCS, IMT-2000, and return path MMDS transmitter applications. It is capable of delivering 3 Watts of output power with high linear gain, high efficiency and excellent linearity. Reliability and performance uniformity are assured by NEC's stringent quality and control procedures

OUTLINE DIMENSIONS (Units in mm)

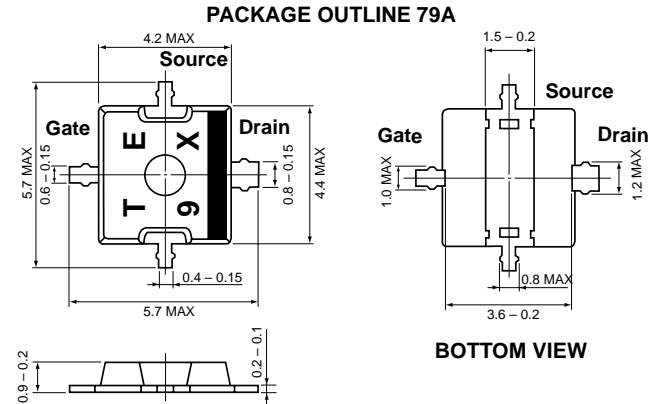

Note: Unless otherwise specified, tolerance is ± 0.2 mm

ELECTRICAL CHARACTERISTICS (T_c = 25°C)

PART NUMBER PACKAGE OUTLINE				NE6500379A 79A			TEST CONDITIONS
Functional Characteristics	SYMBOLS	CHARACTERISTICS	UNITS	MIN	TYP	MAX	
	Functional Characteristics	P _{1dB}	Power Out at 1dB Gain Compression	dBm		35.0	
G _L		Linear Gain ¹	dB	9.0	10.0		
η _{ADD}		Power Added Efficiency	%		50		
I _D		Drain Current	A		1.0		
Electrical DC Characteristics	I _{DSS}	Saturated Drain Current	A		4.5		V _{DS} = 2.5 V; V _{GS} = 0 V
	V _P	Pinch-Off Voltage	V	-3.6	-2.6	-1.6	V _{DS} = 2.5 V; I _{DS} = 21 mA
	R _{TH}	Thermal Resistance	°C/W		5	6	Channel to Case
	BVGD	Gate-to-Drain Breakdown Voltage	V	17			IGD = 21 mA

Notes:

1. Pin = 0 dBm
2. DC performance is tested 100%. Several samples per wafer are tested for RF performance. Wafer rejection criteria for standard devices is 1 reject for several samples.

ABSOLUTE MAXIMUM RATINGS¹ ($T_C = 25^\circ\text{C}$)

SYMBOLS	PARAMETERS	UNITS	RATINGS
V _{DS}	Drain to Source Voltage	V	15
V _{GS}	Gate to Source Voltage	V	-7.0
I _{DS}	Drain Current	A	5.6
I _{GS}	Gate Current	mA	50
P _T	Total Power Dissipation	W	21
T _{CH}	Channel Temperature	°C	150
T _{STG}	Storage Temperature	°C	-65 to +150

Note:

1. Operation in excess of any one of these parameters may result in permanent damage.

RECOMMENDED OPERATING LIMITS

SYMBOLS	PARAMETERS	UNITS	TYP	MAX
V _{DS}	Drain to Source Voltage	V	6.0	6.0
T _{CH}	Channel Temperature	°C		125
G _{COMP}	Gain Compression	dB		3.0

ORDERING INFORMATION

PART NUMBER	QTY
NE6500379A-T1	1 K/Reel
NE6500379A	Bulk, 50 piece min.

TYPICAL PERFORMANCE CURVES ($T_A = 25^\circ\text{C}$)

TOTAL POWER DISSIPATION vs. CASE TEMPERATURE

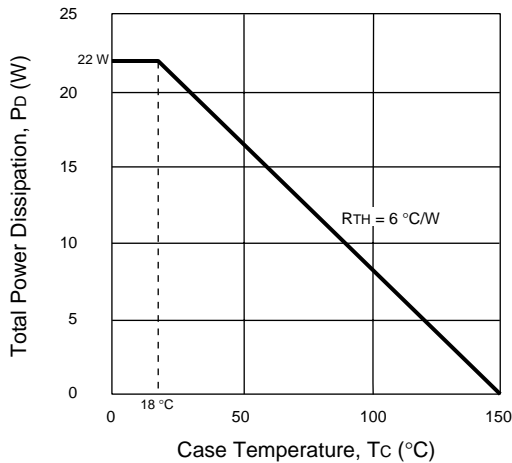

DRAIN CURRENT vs. DRAIN VOLTAGE

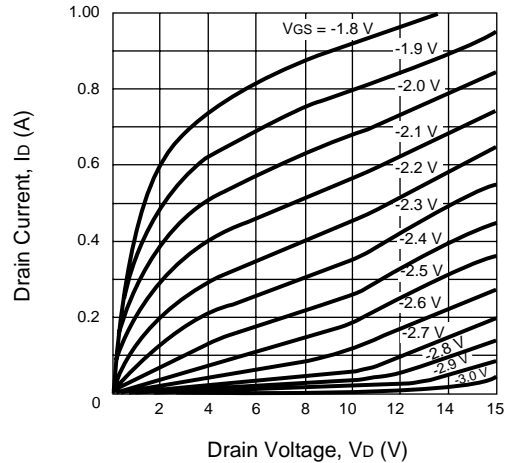

TRANSCONDUCTANCE AND DRAIN CURRENT vs. GATE VOLTAGE

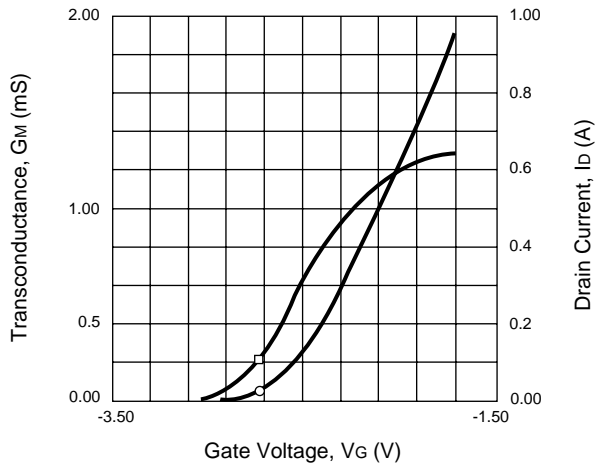

MAXIMUM AVAILABLE GAIN vs. FREQUENCY

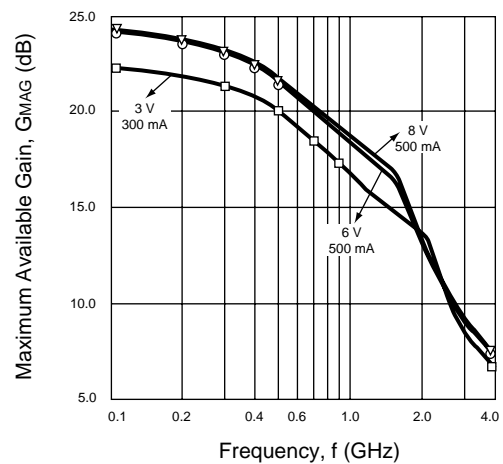

TYPICAL SCATTERING PARAMETERS (TA = 25°C)

Note: This file and many other s-parameter files can be downloaded from www.cel.com

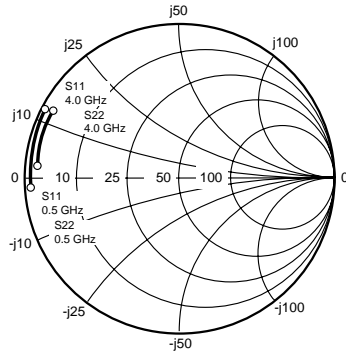

**Coordinates in Ohms
Frequency in GHz
VD = 3.0 V, ID = 300 mA**

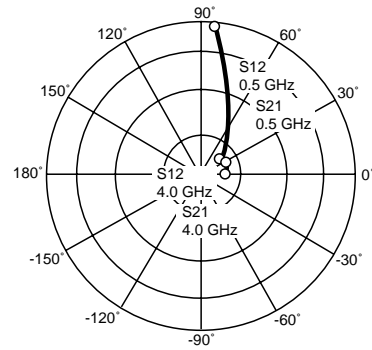

NE6500379A

VD = 6.0 V, ID = 500 mA

FREQUENCY	S11		S21		S12		S22		K	MAG ¹
GHz	MAG	ANG	MAG	ANG	MAG	ANG	MAG	ANG		(dB)
0.50	0.966	-174.30	2.139	85.82	0.014	10.23	0.880	176.31	0.32	21.74
0.60	0.967	-177.11	1.783	82.99	0.014	9.64	0.881	175.27	0.36	20.93
0.70	0.965	-179.62	1.531	80.36	0.014	10.32	0.881	174.08	0.45	20.24
0.80	0.965	178.38	1.343	78.11	0.015	10.26	0.882	173.23	0.50	19.66
0.90	0.965	176.58	1.192	75.93	0.015	10.85	0.881	172.33	0.56	19.12
1.00	0.965	174.96	1.072	73.74	0.015	11.62	0.880	171.34	0.64	18.65
1.10	0.965	173.44	0.975	71.58	0.015	11.65	0.881	170.32	0.69	18.17
1.20	0.965	172.10	0.895	69.70	0.015	12.25	0.881	169.56	0.73	17.77
1.30	0.965	170.80	0.825	67.81	0.015	12.72	0.880	168.73	0.80	17.41
1.40	0.965	169.61	0.765	65.81	0.015	12.90	0.879	167.80	0.84	17.04
1.50	0.965	168.44	0.716	63.89	0.015	13.20	0.881	166.90	0.86	16.75
1.60	0.966	167.32	0.672	62.25	0.015	13.85	0.881	166.23	0.92	16.46
1.70	0.966	166.26	0.632	60.58	0.015	14.68	0.880	165.51	1.00	16.22
1.80	0.966	165.26	0.596	58.64	0.015	14.92	0.877	164.64	1.06	14.46
1.90	0.966	164.32	0.566	56.79	0.015	15.56	0.880	163.73	1.08	13.97
2.00	0.967	163.43	0.540	55.24	0.015	15.70	0.882	163.14	1.08	13.70
2.10	0.968	162.52	0.513	53.75	0.015	17.08	0.880	162.60	1.13	13.00
2.20	0.967	161.56	0.488	51.90	0.015	16.80	0.876	161.72	1.22	12.19
2.30	0.968	160.76	0.468	50.11	0.015	17.63	0.876	160.81	1.27	11.72
2.40	0.968	160.00	0.450	48.58	0.016	18.37	0.881	160.18	1.26	11.55
2.50	0.969	159.26	0.432	47.36	0.016	19.74	0.881	159.90	1.29	11.19
2.60	0.969	158.55	0.413	45.84	0.015	19.89	0.878	159.26	1.34	10.76
2.70	0.970	157.78	0.397	44.14	0.015	20.56	0.877	158.32	1.42	10.32
2.80	0.970	157.08	0.385	42.59	0.015	21.83	0.882	157.46	1.41	10.16
2.90	0.970	156.48	0.372	41.43	0.015	23.56	0.883	157.13	1.44	9.88
3.00	0.971	155.74	0.359	40.09	0.016	24.26	0.881	156.56	1.47	9.56
3.10	0.970	155.08	0.346	38.46	0.016	25.44	0.879	155.69	1.57	9.04
3.20	0.972	154.43	0.336	37.25	0.015	27.74	0.885	154.96	1.54	9.03
3.30	0.971	153.91	0.327	35.97	0.016	29.52	0.885	154.33	1.61	8.55
3.40	0.971	153.33	0.316	34.75	0.016	31.71	0.882	153.69	1.68	8.13
3.50	0.973	152.84	0.308	33.35	0.017	33.06	0.882	152.89	1.56	8.21
3.60	0.974	152.20	0.301	32.01	0.018	32.99	0.884	152.34	1.48	8.14
3.70	0.973	151.72	0.292	30.79	0.018	32.12	0.883	151.99	1.54	7.76
3.80	0.974	151.28	0.282	29.50	0.018	33.04	0.880	151.43	1.54	7.53
3.90	0.973	150.86	0.273	27.94	0.019	31.76	0.877	150.64	1.61	7.12
4.00	0.974	150.75	0.266	27.01	0.019	32.12	0.886	150.34	1.52	7.23

Note:

1. Gain Calculation:

$$MAG = \frac{|S_{21}|}{|S_{12}|} (K - \sqrt{K^2 - 1})$$

. When $K \leq 1$, MAG is undefined and MSG values are used. $MSG = \frac{|S_{21}|}{|S_{12}|}$, $K = \frac{1 + |\Delta|^2 - |S_{11}|^2 - |S_{22}|^2}{2 |S_{12} S_{21}|}$, $\Delta = S_{11} S_{22} - S_{21} S_{12}$

MAG = Maximum Available Gain

MSG = Maximum Stable Gain

APPLICATION CIRCUIT (1.93 - 1.99 GHz)

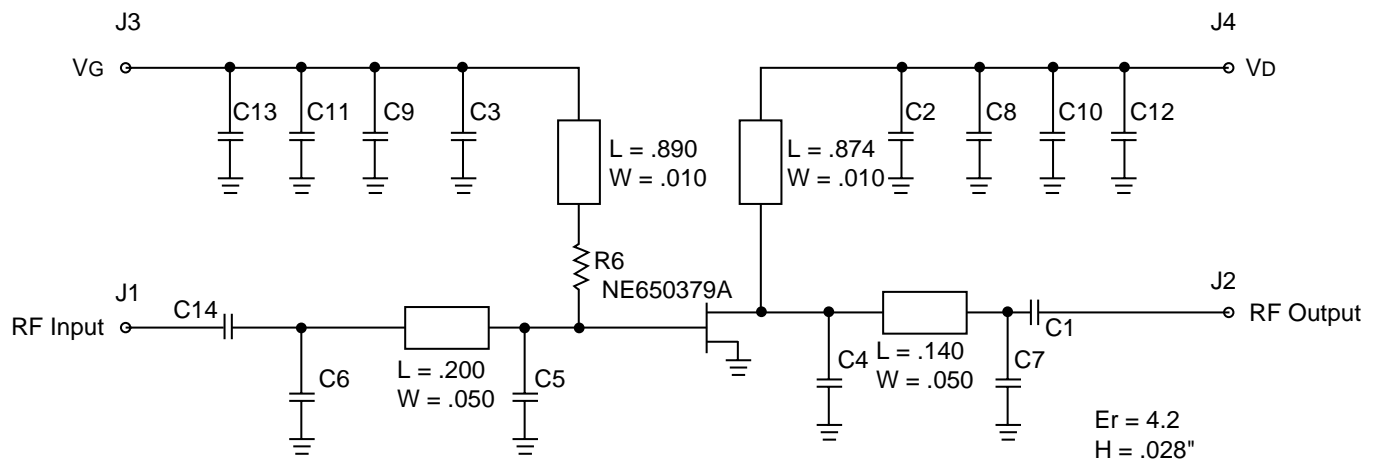
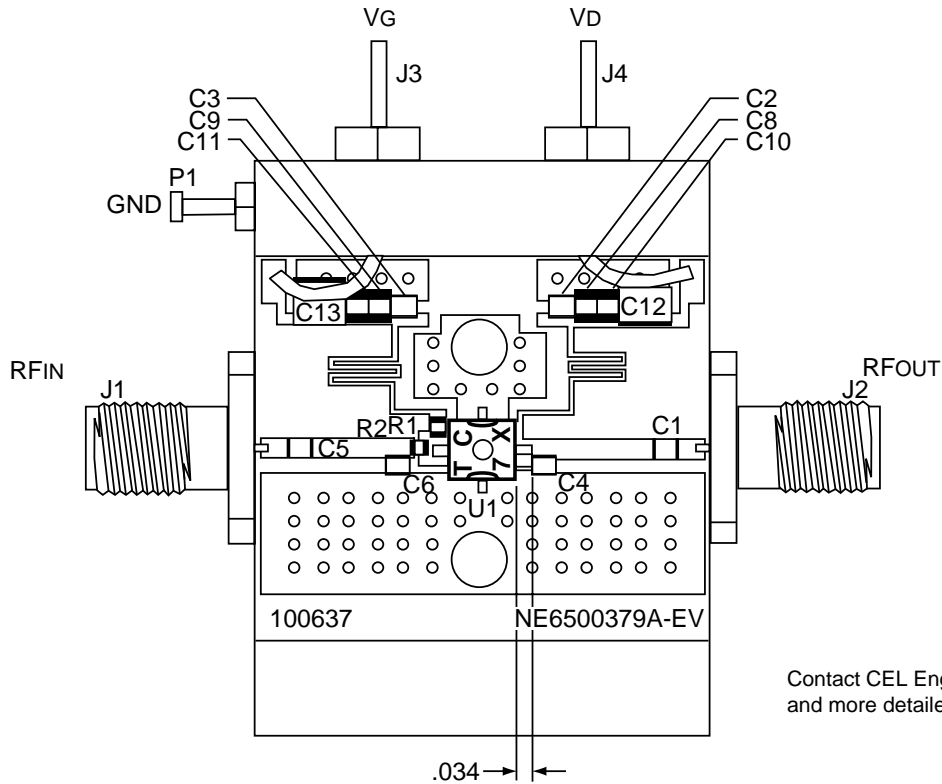

NE6500379A PARTS LIST

1	TF-100637		TEST CIRCUIT BLK	17
4			2-56 X 3/16 PHILLIPS PAN HEAD	16
2	MA101J	C2, C3	CASE 1100 pF CAP MURATA	15
1	MCR03J200	R1	0603 20 OHMS RESISTOR ROHM	14
2	100A470CP150X	C1, C14	CASE A 47 pF CAP ATC	13
1	100A4R3CP150X	C4	CASE A 4.3 pF CAP ATC	12
1	100A5R6CP150X	C5	CASE A 5.6 pF CAP ATC	11
1	100A0R5CP150X	C6	CASE A 0.5 pF CAP ATC	10
1	100A0R8CP150X	C7	CASE A 0.8 pF CAP ATC	9
2	TAJB475K010R	C12, C13	CASE B 4.7 uF CAP AVX	8
2	GRM40X7R104K025BL	C10, C11	0805 .1 uF CAP MURATA	7
2	GRM40C0G102J050BD	C8, C9	0805 1000 pF CAP MURATA	6
1	NE6500379A	U1	IC NEC	5
1	703401	P1	GROUND LUG CONCORD	4
1	1250-003	J3, J4	FEEDTHRU MURATA	3
2	2052-5636-02	J1, J2	FLANGE MOUNT JACK RECEPTACLE	2

P.C.B. LAYOUT (Units in mm)

FOR 79A PACKAGE

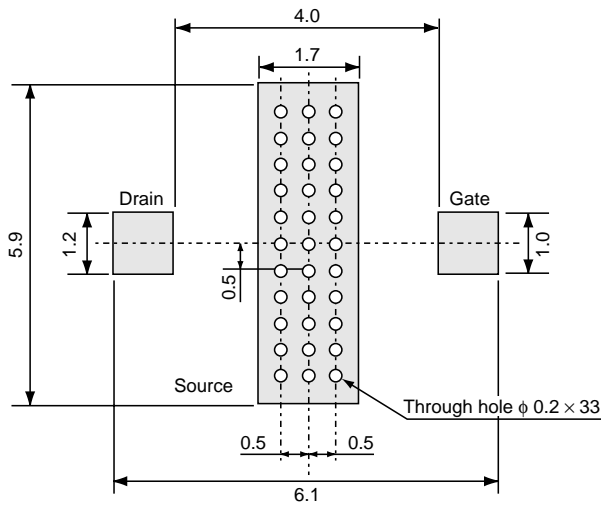

TYPICAL APPLICATION CIRCUIT PERFORMANCE at $V_{DS} = 3\text{ V}$ and $V_{DS} = 6\text{ V}$

GAIN AND PAE vs. OUTPUT POWER

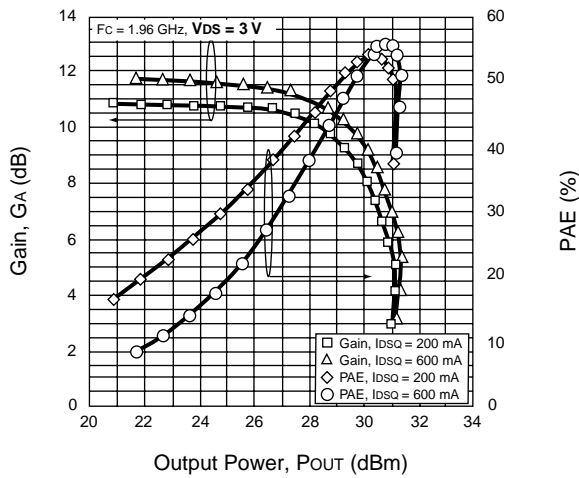

GAIN AND PAE vs. OUTPUT POWER

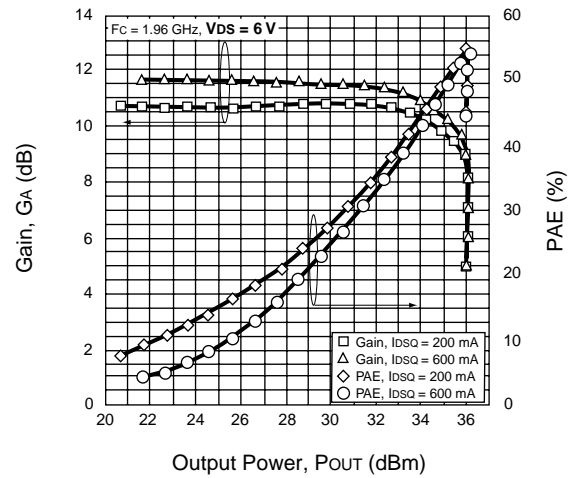

GAIN AND SATURATION POWER vs. FREQUENCY

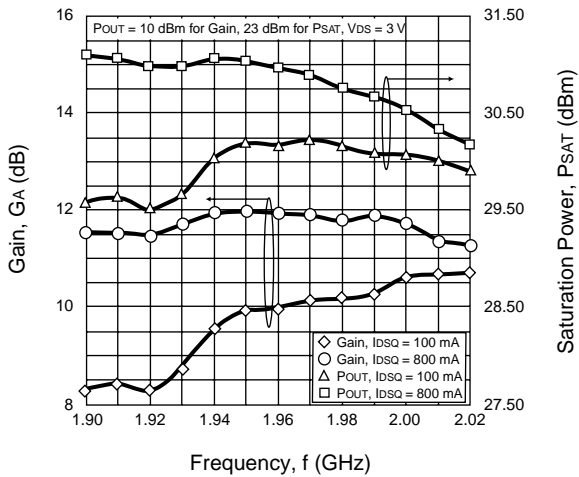

GAIN AND SATURATION POWER vs. FREQUENCY

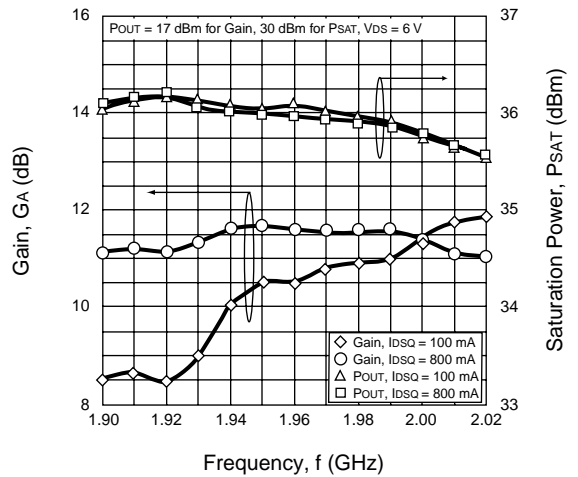

TYPICAL APPLICATION CIRCUIT PERFORMANCE at $V_{DS} = 3\text{ V}$ and $V_{DS} = 6\text{ V}$

THIRD ORDER INTERMODULATION DISTORTION vs. OUTPUT POWER

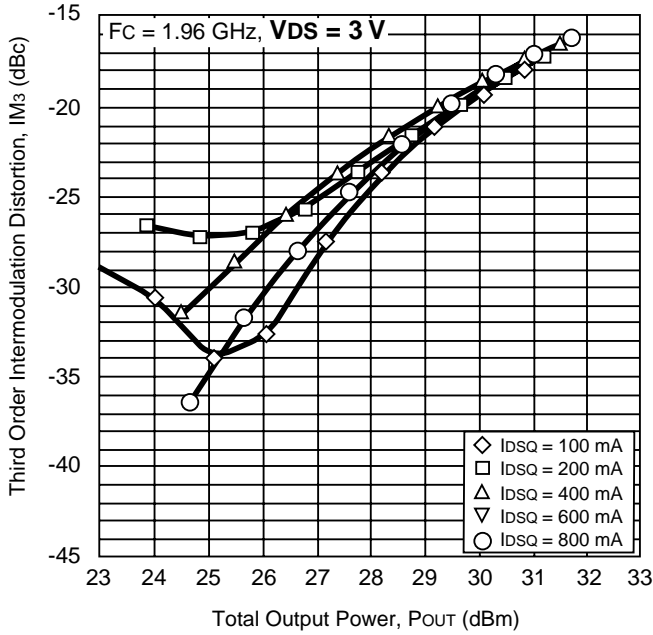

THIRD ORDER INTERMODULATION DISTORTION vs. OUTPUT POWER

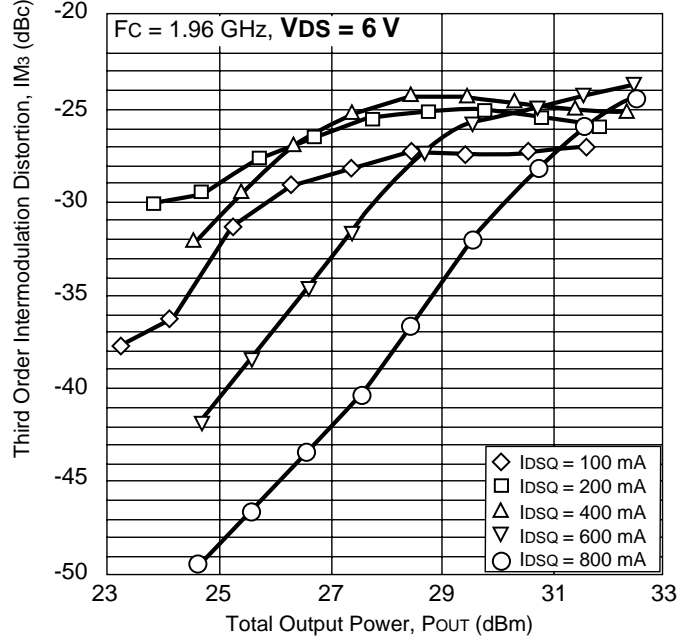

ACPR vs. OUTPUT POWER

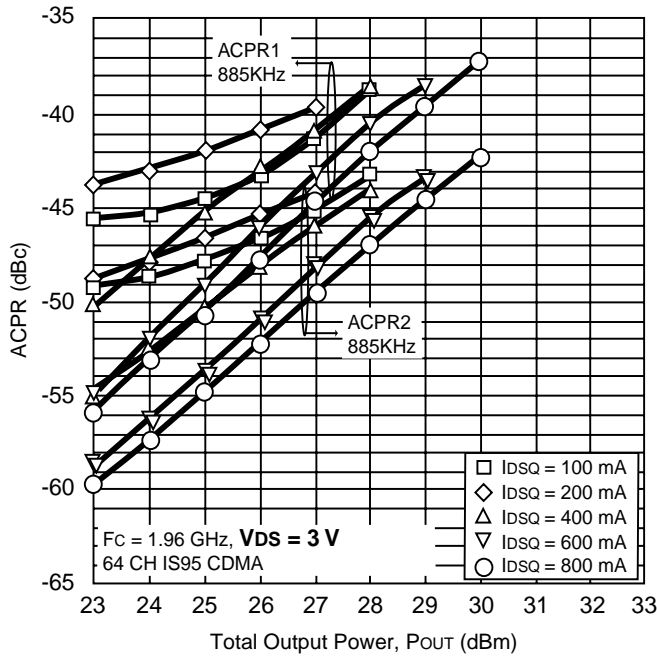

ACPR vs. OUTPUT POWER

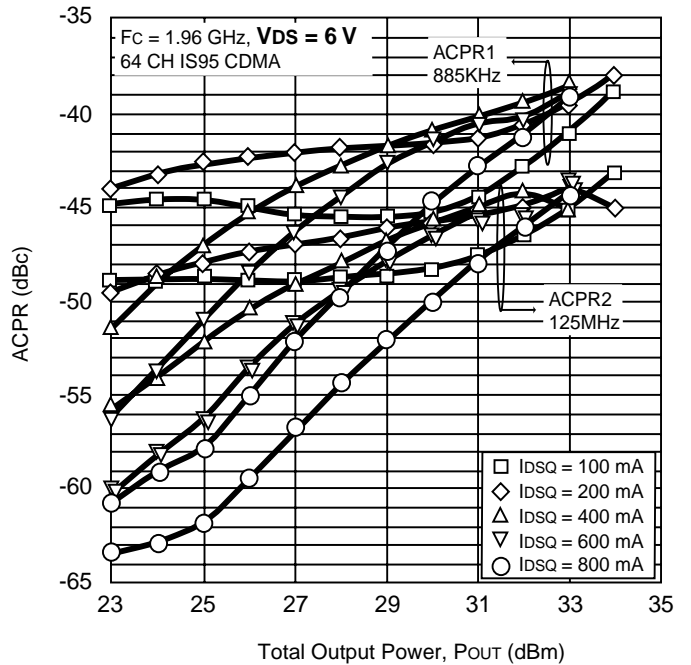

EXCLUSIVE NORTH AMERICAN AGENT FOR **NEC** RF, MICROWAVE & OPTOELECTRONIC SEMICONDUCTORS

CEL CALIFORNIA EASTERN LABORATORIES • Headquarters • 4590 Patrick Henry Drive • Santa Clara, CA 95054-1817 • (408) 988-3500 • Telex 34-6393 • FAX (408) 988-0279
24-Hour Fax-On-Demand: 800-390-3232 (U.S. and Canada only) • Internet: <http://WWW.CEL.COM>

DATA SUBJECT TO CHANGE WITHOUT NOTICE

10/12/2000