

Nov.1.2019 Copyright 2019 HIROSE ELECTRIC CO., LTD. All Rights Reserved.
In case of consideration for using Automotive equipment / device which demand high reliability, kindly contact our sales window correspondents.

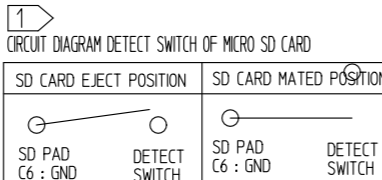

MICRO SD CARD ASSIGNMENT

PIN No.	Name
C1	DAT2
C2	CD/DATA3
C3	CMD
C4	V _{DD}
C5	CLK
C6	V _{SS} (GND)
C7	DAT0
C8	DAT1

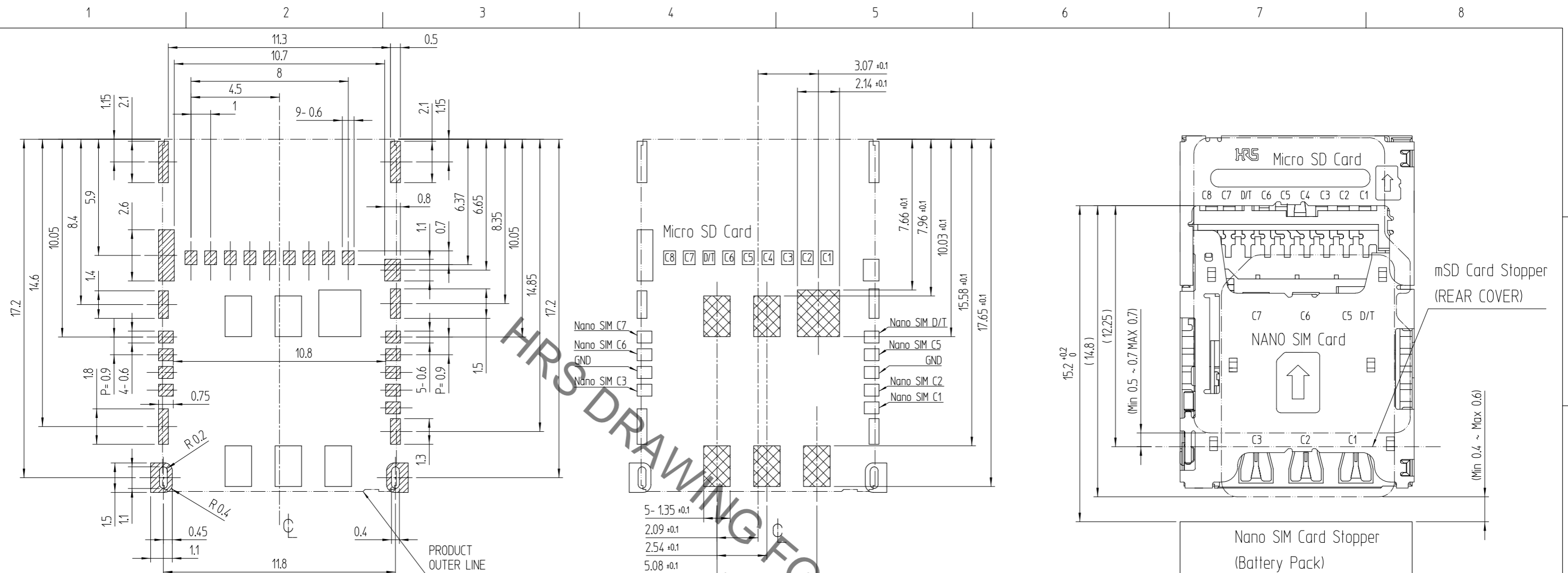
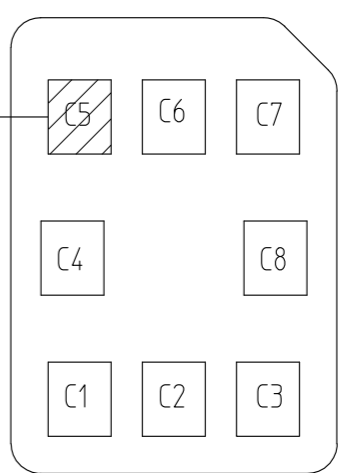
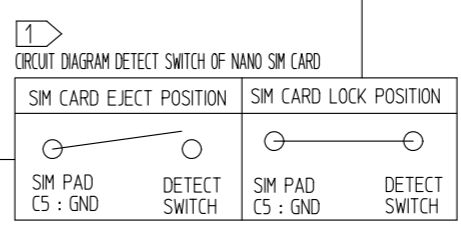
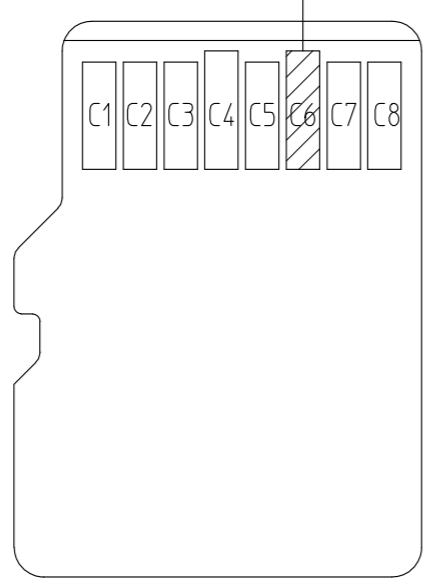

NANO SIM CARD ASSIGNMENT

PIN No.	Name
C1	V _{CC}
C2	RST
C3	CLK
C4	Reserved
C5	GND
C6	V _{PP}
C7	I/O
C8	Reserved

Nov.1.2019 Copyright 2019 HIROSE ELECTRIC CO., LTD. All Rights Reserved.
In case of consideration for using Automotive equipment / device which demand high reliability, kindly contact our sales window correspondents.

4 DRAWING FOR PACKING

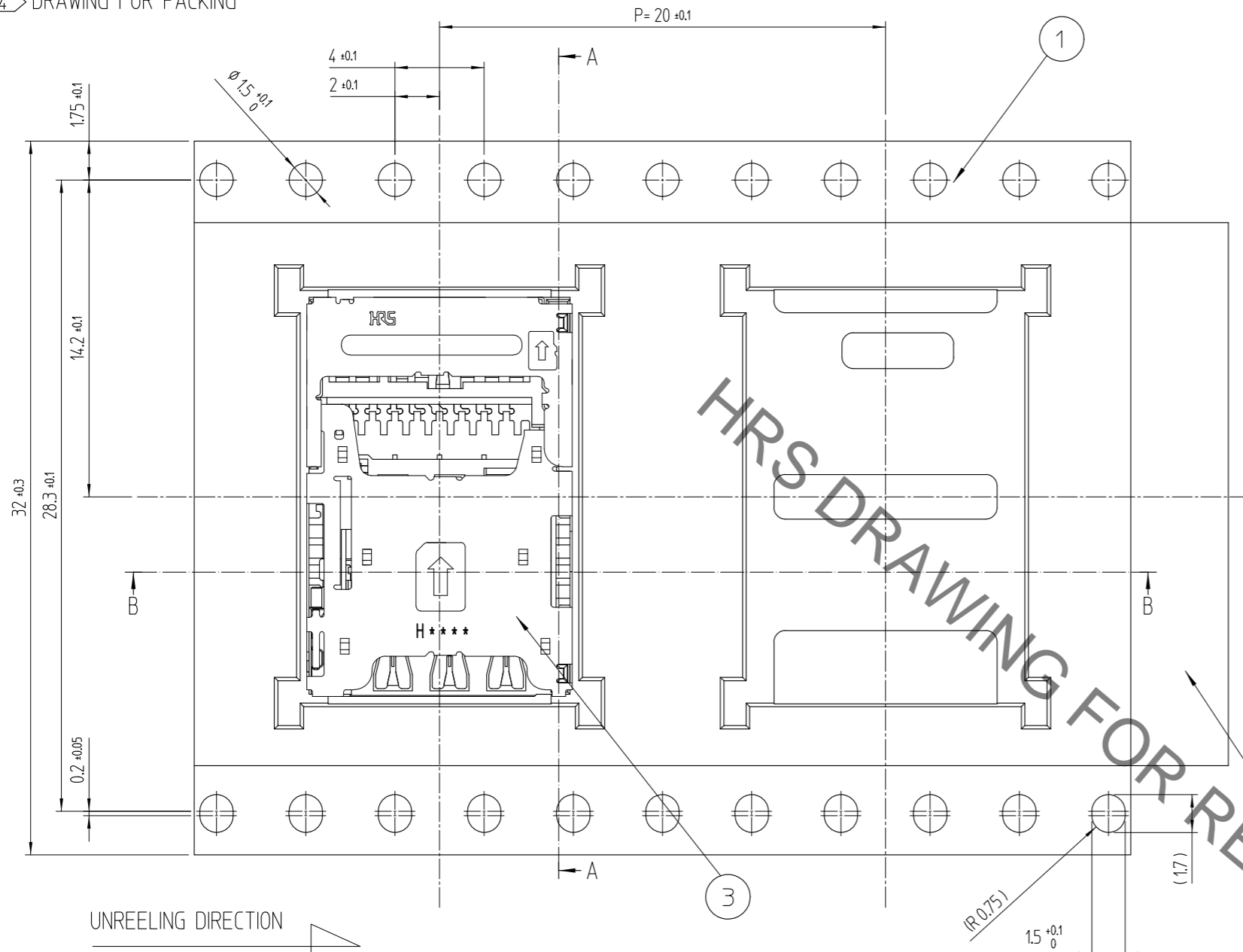

DETAIL OF REEL

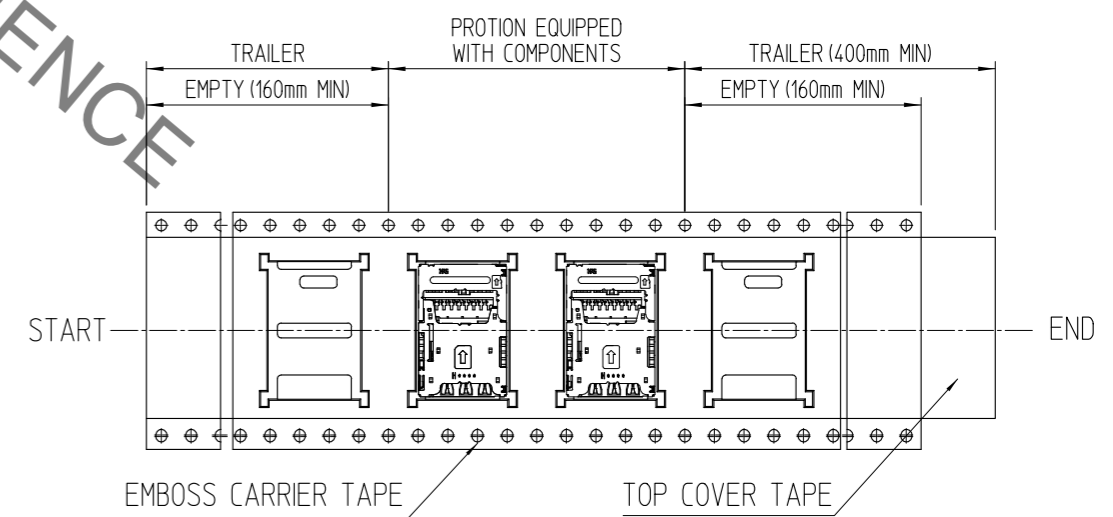
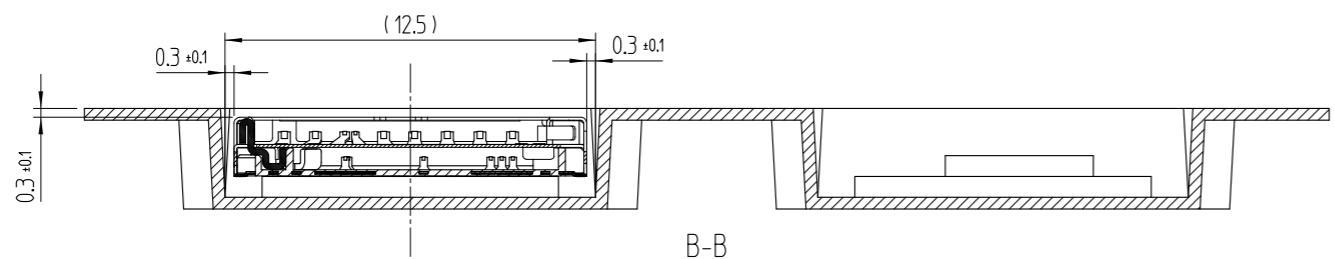
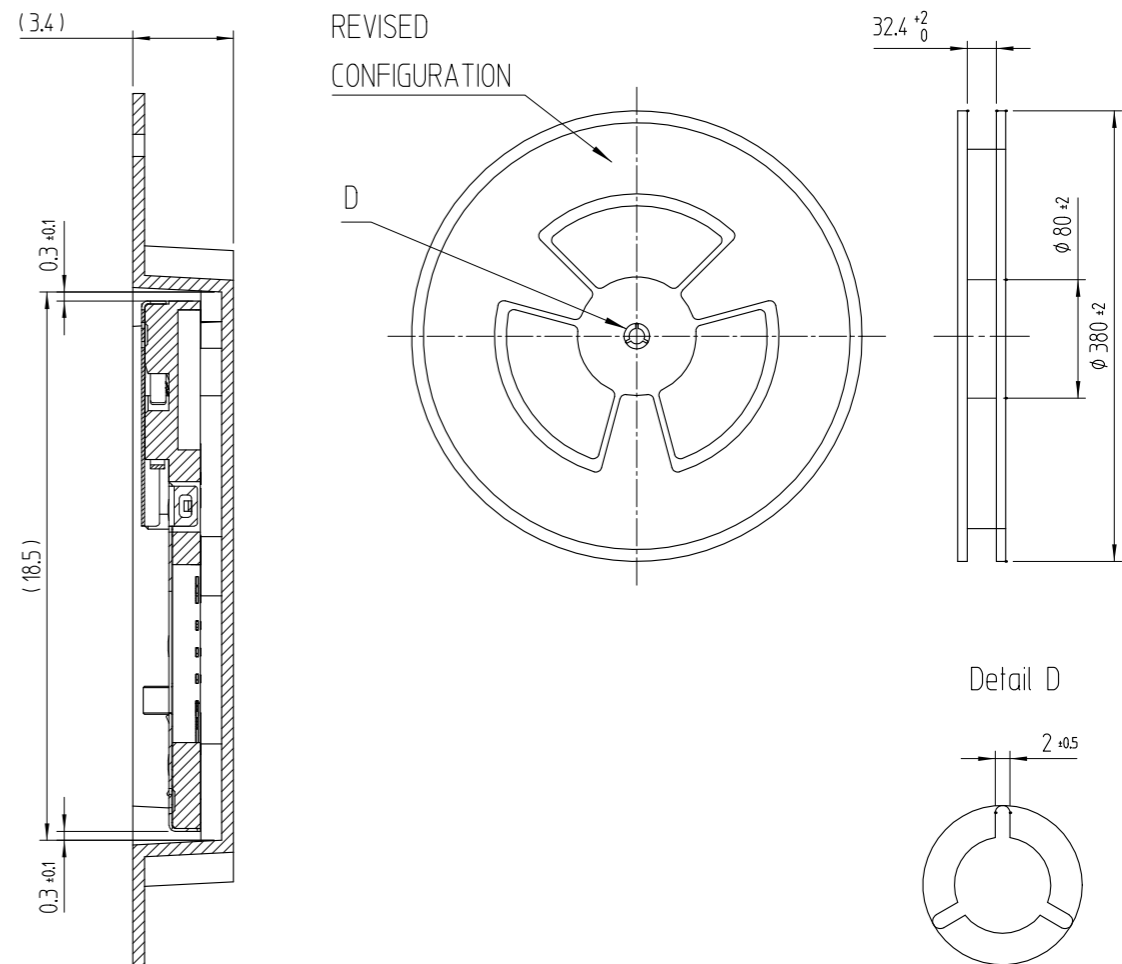

7 MANUFACTURING DATE SYSTEM

H 6 1 26 1 & A

PRODUCTION LINE : LINE No.
DATE : 26TH
MONTH : JAN
YEAR : 2016
SUPPLIER : HIROSE KOREA

7 TABLE.1

YEAR	MONTH	DATE							
YEAR	SYMBOL	MONTH	SYMBOL	DATE	SYMBOL	DATE	SYMBOL	DATE	SYMBOL
2016	6	Jan.	1	1	1	11	11	21	21
2017	7	Feb.	2	2	2	12	12	22	22
2018	8	Mar.	3	3	3	13	13	23	23
2019	9	Apr.	4	4	4	14	14	24	24
2020	0	May.	5	5	5	15	15	25	25
2021	1	Jun.	6	6	6	16	16	26	26
2022	2	Jul.	7	7	7	17	17	27	27
2023	3	Aug.	8	8	8	18	18	28	28
2024	4	Sep.	9	9	9	19	19	29	29
2025	5	Oct.	A	10	10	20	20	30	30
		Nov.	B					31	31
		Dec.	C						

3	(CONNECTOR)	
2	TOP COVER TAPE	POLYESTER
1	EMBOSS CARRIER TAPE	PS
No.	PART	MATERIAL
HRS HIROSE KOREA CO.,LTD.		圖番 DRAWING NO. EDC3-631968

3/3