

ID341G01

Flash Miniature Card

8M

(Model No.: ID341G01)

Spec No.: EL107251
Issue Date: December 25, 1998

- Handle this document carefully for it contains material protected by international copyright law. Any reproduction, full or in part, of this material is prohibited without the express written permission of the company.

- When using the products covered herein, please observe the conditions written herein and the precautions outlined in the following paragraphs. In no event shall the company be liable for any damages resulting from failure to strictly adhere to these conditions and precautions.
 - (1) The products covered herein are designed and manufactured for the following application areas. When using the products covered herein for the equipment listed in Paragraph (2), even for the following application areas, be sure to observe the precautions given in Paragraph (2). Never use the products for the equipment listed in Paragraph (3).
 - Office electronics
 - Instrumentation and measuring equipment
 - Machine tools
 - Audiovisual equipment
 - Home appliances
 - Communication equipment other than for trunk lines

 - (2) Those contemplating using the products covered herein for the following equipment which demands high reliability, should first contact a sales representative of the company and then accept responsibility for incorporating into the design fail-safe operation, redundancy, and other appropriate measures for ensuring reliability and safety of the equipment and the overall system.
 - Control and safety devices for airplanes, trains, automobiles, and other transportation equipment
 - Mainframe computers
 - Traffic control systems
 - Gas leak detectors and automatic cutoff devices
 - Rescue and security equipment
 - Other safety devices and safety equipment, etc.

 - (3) Do not use the products covered herein for the following equipment which demands extremely high performance in terms of functionality, reliability, or accuracy.
 - Aerospace equipment
 - Communications equipment for trunk lines
 - Control equipment for the nuclear power industry
 - Medical equipment related to life support, etc.

 - (4) Please direct all queries and comments regarding the interpretation of the above three Paragraphs to a sales representative of the company.

- Please direct all queries regarding the products covered herein to a sales representative of the company.

Contents

1. General Descriptions	P.	3
2. Features	P.	3
3. Block Diagram	P.	4
4. Pin Connections	P.	5
5. Signal Description	P.	6
6. LH28F016SC Control Logic	P.	7
6.1 Bus Operations	P.	7
6.1.1 Read Array	P.	7
6.1.2 Output Disable	P.	7
6.1.3 Standby	P.	7
6.1.4 Deep Power-Down	P.	7
6.1.5 Read Identifier Codes Operation	P.	8
6.1.6 CUI Writes	P.	8
6.2 Smart Voltage Technology	P.	9
7. Card Control Logic	P.	9
7.1 Word Addressing	P.	9
7.2 Decode Logic	P.	9
7.3 Write Protect Switch	P.	9
7.4 Data Control	P.	10
8. Command Definitions	P.	11
8.1 Read Array Command	P.	12
8.2 Read Identifier Codes Command	P.	12
8.3 Read Status Register Command	P.	12
8.4 Clear Status Register Command	P.	13
8.5 Block Erase Command	P.	13
8.6 Word Write Command	P.	13
8.7 Block Erase Suspend Command	P.	14
8.8 Word Write Suspend Command	P.	14
8.9 Set Block Lock-Bit Command	P.	15
8.10 Clear Block Lock-Bits Command	P.	15
8.11 Status Register	P.	16
8.12 Automated Word Write Flowchart	P.	17
8.13 Automated Block Erase Flowchart	P.	18

9. Electrical Specifications	P. 19
9. 1 Absolute Maximum Ratings	P. 19
9. 2 Recommended Operating Conditions	P. 19
9. 3 Capacitance	P. 19
9. 4 AC Input/Output Test Conditions	P. 19
10. DC Characteristics	P. 20
11. AC Characteristics	P. 21
11. 1 Read Operations	P. 21
11. 2 AC Waveforms for Read Operations	P. 21
11. 3 Write Operations	P. 22
11. 3. 1 WE# Controlled Write Operations	P. 22
11. 3. 2 CE# Controlled Write Operations	P. 22
11. 3. 3 AC Waveforms for Write Operations (WE# Controlled)	P. 23
11. 3. 4 AC Waveforms for Write Operations (CE# Controlled)	P. 24
11. 4 Erase and Data Write Performance	P. 25
11. 5 Power-Up	P. 26
12. Specification Changes	P. 27
13. Other Precautions	P. 27
14. External Dimensions	P. 28
15. Packing Specification	P. 29
16. External Appearances	P. 30

1. General Descriptions

The SHARP ID341G01, which panel design is SHARP standard, is a 8MB Flash Memory Miniature Card conforms to Miniature Card Specification Release 1.1 and is offered to customers giving aim to confirm an external shape or electrical performances of the card. Before mass production, we will create a new product name dedicated for a customer and also present a specification which implies customer's request including panel design.

2. Features

- | | | |
|------|--|--|
| 2.1 | Type | 8MB Flash Memory Miniature Card
(Conforms to Miniature Card Specification Release 1.1) |
| 2.2 | Memory Capacity | |
| | Main Memory | 4M words × 16 bits (8M words × 8 bits) |
| 2.3 | Supply Voltage | 3.3V ± 0.3V or 5.0V ± 5% |
| 2.4 | Erase Unit | 64K word Blocks |
| 2.5 | Program/Erase Cycles | 100,000 cycles per Block |
| 2.6 | Interface | Parallel I/O Interface |
| 2.7 | Function Table | See Function Table in page. 10 |
| 2.8 | External Dimensions | 33.0 × 38.0 × 3.5 mm |
| 2.9 | Pin Connections | See Pin Connections in page. 5 |
| 2.10 | Type of Connector | Conforms to Miniature Card Specification Release 1.1 Card Use Connector |
| 2.11 | Average Weight | 9g |
| 2.12 | Operating Temp. Range | 0 to 60°C |
| 2.13 | Storage Temp. Range | -30 to 70°C |
| 2.14 | External Appearance | External appearance shall be free of any dirt, cratches and abnormalities that could adversely affect sales. |
| 2.15 | Manufacturer's Code | The manufacturer's code shall be printed on the Miniature card directly or on the seal which is then attached to the Miniature card. |
| 2.16 | Brand Name | The user's brand name will used. |
| 2.17 | Not designed for rated radiation hardened. | |

3. Block Diagram

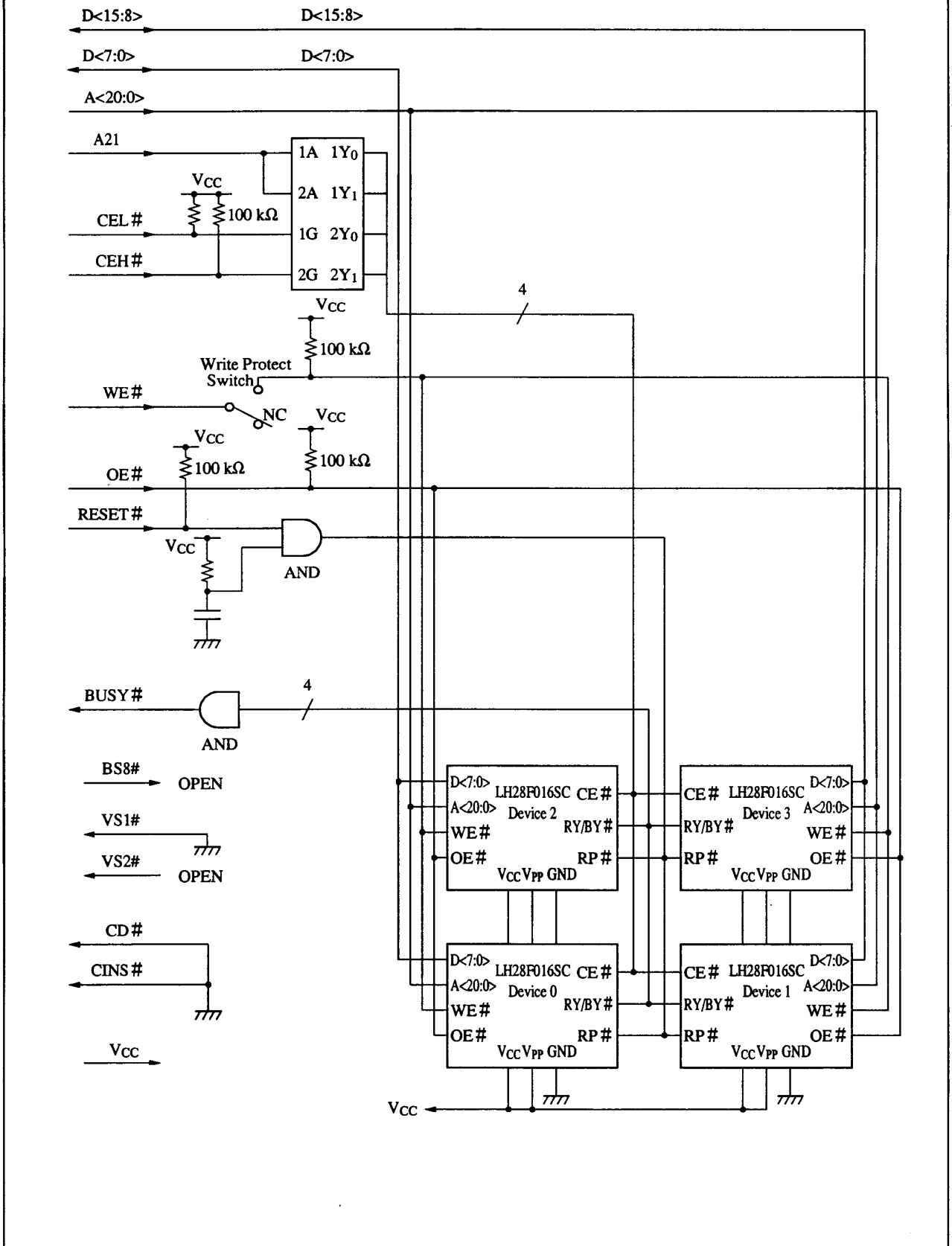

4. Pin Connections

Interface Signals

PAD#	SIGNAL	I/O	FUNCTION	ACTIVE	PAD#	SIGNAL	I/O	FUNCTION	ACTIVE
1	A ₁₈	I	Address Bit 18		31	A ₁₉	I	Address Bit 19	
2	A ₁₆	I	Address Bit 16		32	A ₁₇	I	Address Bit 17	
3	A ₁₄	I	Address Bit 14		33	A ₁₅	I	Address Bit 15	
4	V _{ccr}	I	Voltage Refresh	N.C.	34	A ₁₃	I	Address Bit 13	
5	CEH#	I	Card Enable High Byte	Low	35	A ₁₂	I	Address Bit 12	
6	A ₁₁	I	Address Bit 11		36	RESET#	I	Reset	Low
7	A ₉	I	Address Bit 9		37	A ₁₀	I	Address Bit 10	
8	A ₈	I	Address Bit 8		38	VS ₁ #	O	Voltage Sence 1	Low
9	A ₆	I	Address Bit 6		39	A ₇	I	Address Bit 7	
10	A ₅	I	Address Bit 5		40	BS8#	I	Bus Size 8	N.C.
11	A ₃	I	Address Bit 3		41	A ₄	I	Address Bit 4	
12	A ₂	I	Address Bit 2		42	CEL#	I	Card Enable Low Byte	Low
13	A ₀	I	Address Bit 0		43	A ₁	I	Address Bit 1	
14	RAS#	I	Row Address Strobe	N.C.	44	CASL#	I	Column Address Strobe Low Byte	N.C.
15	A ₂₄	I	Address Bit 24	N.C.	45	CASH#	I	Column Address Strobe High Byte	N.C.
16	A ₂₃	I	Address Bit 23	N.C.	46	CD#	O	Card Detect	Low
17	A ₂₂	I	Address Bit 22	N.C.	47	A ₂₁	I	Address Bit 21	
18	OE#	I	Output Enable	Low	48	BUSY#	O	Ready/Busy	Low
19	D ₁₅	I/O	Data Bit 15		49	WE#	I	Write Enable	Low
20	D ₁₃	I/O	Data Bit 13		50	D ₁₄	I/O	Data Bit 14	
21	D ₁₂	I/O	Data Bit 12		51	RFU		Reserved	
22	D ₁₀	I/O	Data Bit 10		52	D ₁₁	I/O	Data Bit 11	
23	D ₉	I/O	Data Bit 9		53	VS ₂ #	O	Voltage Sence 2	N.C.
24	D ₀	I/O	Data Bit 0		54	D ₈	I/O	Data Bit 8	
25	D ₂	I/O	Data Bit 2		55	D ₁	I/O	Data Bit 1	
26	D ₄	I/O	Data Bit 4		56	D ₃	I/O	Data Bit 3	
27	RFU		Reserved		57	D ₅	I/O	Data Bit 5	
28	D ₇	I/O	Data Bit 7		58	D ₆	I/O	Data Bit 6	
29	SDA	I/O	Serial Data and Address	N.C.	59	RFU		Reserved	
30	SCL	I	Serial Clock	N.C.	60	A ₂₀	I	Address Bit 20	

Power/Insertion Signals

SIGNAL NO.	SIGNAL
61	GND
62	CINS#
63	V _{cc}

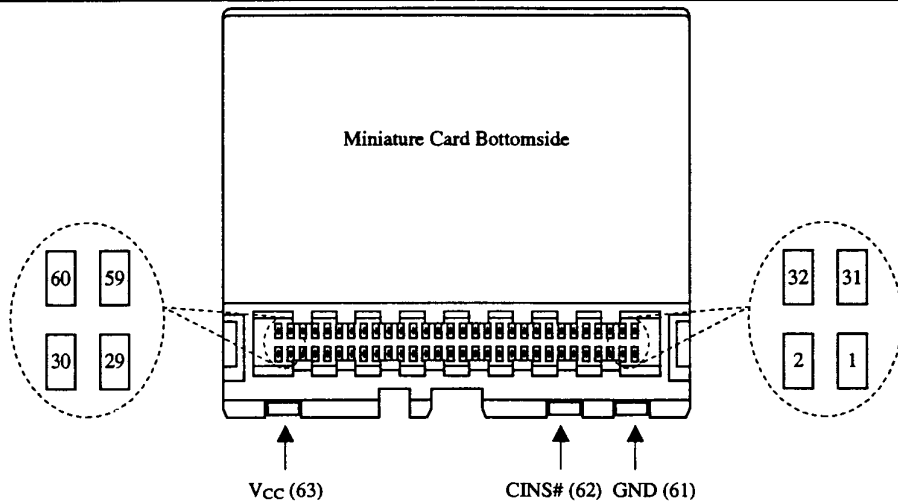

Figure 1. Card Interface Signal Assignment

5. Signal Description

Interface Signal Description

Symbol	Type	Name and Function
A ₀ -A ₂₄	INPUT	ADDRESS INPUTS: Addresses A ₀ through A ₂₄ enable direct addressing of up to 64 MB of memory on the card. The memory will wrap at the card density boundary. The system should NOT try to access memory beyond the card's density, since the upper addresses are not decoded.
D ₀ -D ₁₅	INPUT/ OUTPUT	DATA INPUT/OUTPUT: D ₀ through D ₁₅ constitute the bi-directional data bus. D ₁₅ is the most significant bit.
CEL# CEH#	INPUT	CARD ENABLE LOW & HIGH: CEL# enables accesses on the low byte of the data bus D ₀ -7. CEH# enables accesses on the high byte of the data bus D ₈ -15. Both CEL# and CEH# are active low signals. A 16-bit host must always assert both CEL# and CEH#.
OE#	INPUT	OUTPUT ENABLE: Active low signal, enables read data from the Miniature card.
WE#	INPUT	WRITE ENABLE: Active low signal, enables write data to the Miniature card.
BUSY#	OUTPUT	BUSY: Active low signal, indicates the status of internally timed erase or write activities. A high output indicates the Miniature card is ready to accept another command
CD#	OUTPUT	CARD DETECT: Active low signal, provides for card insertion detection. CD# connects to ground internally on the Miniature card, and will be forced low when the CD# interface signal connects to the host.
RESET#	INPUT	RESET: Active low input signal, resets the device's command user interface and places the card into a deep power-down mode. The host must drive this signal.
VS ₁ # VS ₂ #	OUTPUT	VOLTAGE SENSE: Notifies the host socket of the card's V _{CC} requirements. VS ₁ # is grounded and VS ₂ # is left open to indicate a 3.3V capable card has been inserted.
RFU	—	RESERVED FOR FUTURE USE

Power/Insertion Signal Description

Symbol	Type	Name and Function
CINS#	OUTPUT	CARD INSERTION DETECT: This signal provides for early card insertion detection. CINS# connects to ground internally on the Miniature card, and will be forced low when the power/insertion signals connect to the host.
V _{CC}	—	CARD POWER SUPPLY: 3.3V or 5.0V
GND	—	GROUND

6. LH28F016SC Control Logic

6.1 Bus Operations

The host executes read, write and erase operations by issuing the appropriate command to the flash device's Command User Interface (CUI). The CUI serves as the interface between the host processor and internal operation of the flash device. These commands can be issued to the CUI using standard microprocessor bus cycles.

6.1.1 Read Array

The host enables reads from the card by writing the appropriate read command to the CUI. The LH28F016SC automatically resets to read array mode upon initial device power-up, or after reset. CEL#, CEH#, and OE# must be logically active to obtain 16 data bits at the outputs. The Card Enables (CEL# and CEH#) are used to select the addressed devices. Output Enable (OE#) is the data input/output (D0–D15) direction control, and when active, drives data from the selected memory onto the data bus. WE# must be driven to V_{IH} during a read access.

6.1.2 Output Disable

With OE# at a logic-high level (V_{IH}), the device outputs are disabled. Outputs (D0–D15) are placed in a high-impedance state.

6.1.3 Standby

CEL# and CEH# at a logic-high level (V_{IH}) places the card in standby mode. Standby operation disables much of the card's circuitry and substantially reduces device power consumption. The outputs (D0–D15) are placed in a high-impedance state independent of the status of OE#. If the host deselects the card during a write or erase, the card continues to function and consume normal active power until the operation completes.

6.1.4 Deep Power-Down

RESET# at V_{IL} initiates the deep power-down mode.

During reads, an active RESET# deselects the memory, places output drivers in a high-impedance state, and turns off all internal circuits. RESET# must be held low for a minimum of 100 ns. After returning from deep power-down, the host must wait before initial memory access outputs are valid, as determined by t_{PHQV} . After this wake-up interval, the host can resume normal operations to the card. Card reset forces the CUI to reset to read array mode and sets the status register to 80H.

During block erase, byte write, or lock-bit configuration modes, an active RESET# will abort the operation. BUSY# remains low until the reset operation completes. Memory contents being altered are no longer valid; the data may be partially erased or written. The host must wait after RESET# goes to logic-High (V_{IH}) before it can write another command, as determined by t_{PHWL} .

It is important to assert RESET# to the card during a system reset. If a CPU reset occurs without a card reset, the host will not be able to read from the card if that card is in a different mode when the system reset occurs.

For example, if an end-user initiates a host reset when the card is in read status register mode, the host will attempt to read code from the card, but will actually read status register data.

Sharp's ID341 Series Flash Memory Miniature Card allows proper card reset following a system reset through the use of the RESET# input. System RESET# circuitry can reset the host CPU in addition to the card.

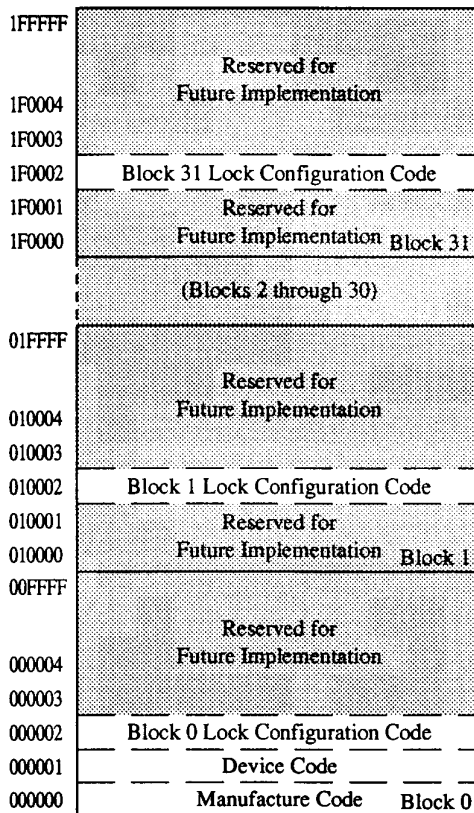

Figure 2. Device Identifier Code Memory Map

6. 1. 5 Read Identifier Codes Operation

The read identifier codes operation outputs the manufacturer code (Block 0), device code (Block 0), and block lock configuration codes (for each block), see Figure 2. Using the manufacturer and device codes, the system CPU can automatically match the device with its proper algorithms. The block lock codes identify locked and unlocked blocks.

6. 1. 6 CUI Writes

Writes to the CUI enable reading of device data and intelligent identifiers. They also control inspection and clearing of the Status Register. The contents of the interface register serves as input to the internal state machine on each component.

The CUI itself does not occupy an addressable memory location. The interface register is a latch used to store the command, address and data information needed to execute the command. Erase Setup and Erase Confirm commands require both appropriate command data and an address within the block to be erased. The Write Setup command requires both appropriate command data and the address of the location to be written, while the Write command consists of the data to be written and the address of the location to be written.

The CUI is written by bringing WE# to a logic-low level (V_{IL}) while CEL#,CEH# is low. Addresses and data are latched on the rising edge of WE#. Standard microprocessor write timings are used.

When a write or erase command has been issued to the CUI, the internal Write State Machine (WSM) becomes busy and will not be ready until it has completed the operation.

6.2 Smart Voltage Technology

SmartVoltage technology provides a choice of V_{CC} at 3.3V or 5.0V. V_{CC} at 3.3V consumes approximately one-fourth the power of V_{CC} at 5.0V. However, V_{CC} at 5.0V provides the highest read performance. Internal device detection circuitry automatically configures the device.

7. Card Control Logic

7.1 Word Addressing

Sharp's ID341 Series Flash Memory Miniature Card uses two $\times 8$ devices in parallel to form the Miniature card $\times 16$ data bus. If the host writes a command to the card, it must make sure that it writes the command to both devices in the card. For example, a component write command is 40H, so a card write command must be 4040H. This same procedure must be followed when reading from the status register. A component status register is only 8 bits and may return 80H when read. However, the card status register is 16 bits and may return 8080H.

7.2 Decode Logic

The decode logic enables the appropriate component device pair during a read or write access. Unused upper addresses for the ID341 Series Flash Memory Miniature Card will not be decoded. The address decoding will wrap around at the card's density.

7.3 Write Protect Switch

The ID341 Series Flash Memory Miniature Card has a write protect switch on the side of the card. When the switch is in the write protect position, the card blocks all writes to the card (see Figure 3).

NOTE

When the write protect switch is in the write protect position, all writes are disabled to the flash array including all commands to the CUI.

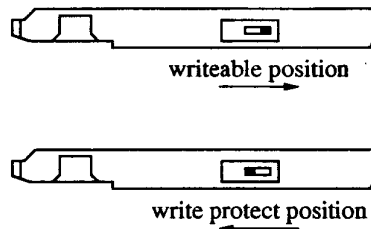

NOTE:

The write protect switch is represented by the solid black rectangle.

Figure 3. Write Protect Switch

7.4 Data Control

As shown in Table 1, data paths and directions are selected by the Data Control logic using WE#, OE#, CEL#, and CEH#, as logic inputs.

NOTE:

This card has a $\times 16$ interface. The High byte CANNOT be accessed on the lower data path (D₀₋₇).

Mode	RESET#	CEH#	CEL#	OE#	WE#	A ₀	D ₈₋₁₅	D ₀₋₇	Notes
Low Byte-Read	V _{IH}	V _{IH}	V _{IL}	V _{IL}	V _{IH}	×	High-Z	Low ⁽⁶⁾	1.2.3
High Byte-Read	V _{IH}	V _{IL}	V _{IH}	V _{IL}	V _{IH}	×	High ⁽⁶⁾	High-Z	1.2.3
Word-Read	V _{IH}	V _{IL}	V _{IL}	V _{IL}	V _{IH}	×	High ⁽⁶⁾	Low ⁽⁶⁾	1.2.3
Low Byte-Write	V _{IH}	V _{IH}	V _{IL}	V _{IH}	V _{IL}	×	×××	Low ⁽⁶⁾	3.4
High Byte-Write	V _{IH}	V _{IL}	V _{IH}	V _{IH}	V _{IL}	×	High ⁽⁶⁾	×××	3.4
Word-Write	V _{IH}	V _{IL}	V _{IL}	V _{IH}	V _{IL}	×	High ⁽⁶⁾	Low ⁽⁶⁾	3.4
Manufacturer ID	V _{IH}	V _{IL}	V _{IL}	V _{IL}	V _{IH}	V _{IL}	89H	89H	—
Device ID	V _{IH}	V _{IL}	V _{IL}	V _{IL}	V _{IH}	V _{IH}	AAH	AAH	5
Standby	V _{IH}	V _{IH}	V _{IH}	×	×	×	High-Z	High-Z	—
Output Disable	V _{IH}	×	×	V _{IH}	V _{IH}	×	High-Z	High-Z	—
Power-Down	V _{IL}	×	×	×	×	×	High-Z	High-Z	—

Table 1. Function Table

NOTES:

1. Refer to DC Characteristics.
2. × can be V_{IL} or V_{IH} for control pins and address.
3. BUSY# is V_{OL} when the WSM is executing internal byte write or block erase algorithms. It is V_{OH} when the WSM is not busy, in erase suspend mode, or deep power-down mode.
4. Refer to Table 2 for valid D_{IN} during a write operation.
5. Although the device code is AAH, other Sharp's Flash Memory Miniature Card could also have device codes A6H or A7H. Software should check for all three cases for compatibility with future cards.
6. High indicates high byte data, Low indicates low byte data.

8. Command Definitions

Device operations are selected by writing specific commands into the Command User Interface. Table 2 defines the LH28F016SC commands.

NOTE:

When the write protect switch is in the write protect position, all writes are disabled to the flash array including commands to the CUI.

Table 2. Command Definitions ⁽⁶⁾

Command	Bus Cycles Req'd.	Notes	First Bus Cycle			Second Bus Cycle		
			Oper ⁽¹⁾	Addr ⁽²⁾	Data ⁽³⁾	Oper ⁽¹⁾	Addr ⁽²⁾	Data ⁽³⁾
Read Array/Reset	1	—	Write	×	FFFFH	—	—	—
Read Identifier Codes	≥2	4	Write	×	9090H	Read	IA	ID
Read Status Register	2	—	Write	×	7070H	Read	×	SRD
Clear Status Register	1	—	Write	×	5050H	—	—	—
Block Erase	2	—	Write	BA	2020H	Write	BA	D0D0H
Word Write	2	5	Write	WA	4040H or 1010H	Write	WA	WD
Block Erase and Word Write Suspend	1	—	Write	×	B0B0H	—	—	—
Block Erase and Word Write Resume	1	—	Write	×	D0D0H	—	—	—
Set Block Lock-Bit	2	—	Write	BA	6060H	Write	BA	0101H
Clear Block Lock-Bits	2	—	Write	×	6060H	Write	×	D0D0H

NOTES:

1. Bus operations are defined in Table 1.
2. × = Any valid address within the device.
IA = Identifier Code Address: see Figure 2.
BA = Address within the block being erased or locked.
WA = Address of memory location to be written.
3. SRD = Data read from status register. See Table 4 for a description of the status register bits.
WD = Data to be written at location WA. Data is latched on the rising edge of WE# or CE# (Whichever goes high first).
ID = Data read from identifier codes.
4. Following the Read Identifier Codes command, read operations access manufacturer, device and block lock configuration codes. See Section 8.2 for read identifier code data.
5. Either 40H or 10H are recognized by the WSM as the byte write setup.
6. Commands other than those shown above are reserved for future device implementations and should not be used.

8.1 Read Array Command

Upon initial device power-up and after exit from deep power-down mode, the card defaults to read array mode. The host can also read by writing the Read Array command. The device remains enabled for reads until the host writes another valid command. Once the internal WSM has started a block erase, byte write or lock-bit configuration, the device will not recognize the Read Array command until the WSM completes its operation. However, the host can suspend the WSM using an Erase Suspend or Word Write Suspend command.

8.2 Read Identifier Codes Command

The host initiates the identifier code operation by writing the Read Identifier Codes command. Following the command write, read cycles from addresses shown in Figure 2 retrieve the manufacturer, device and block lock configuration codes (see Table 3 for identifier code data). To terminate the operation, write another valid command. Although Table 3 lists the device code as AAAA, other Sharp's Flash Memory Miniature Card could also have device codes A6A6 or A7A7. Host software should check for all three cases for compatibility with future cards.

Table 3. Identifier Codes

Code	Address	Data ⁽²⁾
Manufacture Code	00000	8989
Device Code	00001	AAAA
Block Lock Configuration	× 0002 ⁽¹⁾	
• Block is Unlocked		D _{0,8} = 0
• Block is Locked		D _{0,8} = 1
• Reserved for Future Use		D _{1-7,9-15}

NOTES:

1. × selects the specific block lock configuration code to be read. See Figure 2 for the device identifier code memory map.
2. The addresses listed are word addresses and store 16 bits of data.

8.3 Read Status Register Command

The LH28F016SC components on the ID341 Series Flash Memory Miniature Card each contain a Status Register which may be read to determine when a write, block erase, or lock bit configuration is complete, and whether that operation completed successfully (see Table 4). The host may read the Status Register at any time by writing the Read Status Register command to the CUI. After writing this command, all subsequent read operations output data from the Status Register, until the host writes another valid command to the CUI. The flash components latch the contents of the Status Register on the falling edge of OE# or CE#, whichever occurs first. OE# or CE# must be toggled to V_{IH} before further reads to update the Status Register latch.

NOTE:

The ID341 Series Flash Memory Miniature Card arranges two LH28F016SC devices in parallel to from a ×16 bus. Both status registers need to be checked when determining the status of a ×16 erase/write operation.

8.4 Clear Status Register Command

The WSM sets the Erase Status and Write Status bits to “1”s and they can only be reset by the Clear Status Register command. The WSM sets these bits to “1” when a write or erase operation has failed. The host can issue additional write and erase commands to the CUI without clearing the status register. This allows a system to write a sequence of bytes before checking the write status bit. However, if an error has occurred the system will not know which write in the sequence has failed. To clear the Status Register, the Clear Status Register command (5050H) is written to the CUI.

NOTE:

If V_{PP} has not been turned on, the WSM sets the V_{PP} status bit. However, the ID341 Series Flash Memory Miniature Card ties V_{PP} and V_{CC} on the LH28F016SC devices together so if V_{CC} is on then V_{PP} will also be on. If for some reason the WSM sets the V_{PP} Status bit, the host must clear the status register before it attempts further writes or block erases.

8.5 Block Erase Command

The host executes an erase command one block at a time using a two-cycle command. The host writes a block erase setup command first, followed by a block erase confirm command. These two commands require appropriate sequencing and an address within the block to complete (erase changes all block data to FFH). The WSM handles block preconditioning, erase, and verify internally (invisible to the system). After the host writes the two-cycle block erase sequence, the device automatically outputs status register data when read. The CPU can detect block erase completion by analyzing the output data of the BUSY# signal or status register bit SR.7.

When the block erase completes, status register bit SR.5 should be checked. If a block erase error is detected, the host should clear the status register before system software attempts corrective actions. The CUI remains in read status register mode until the host issues a new command.

This two-step command sequence of set-up followed by execution ensures that block contents are not accidentally erased. An invalid Block Erase command sequence will result in the WSM setting status register bits SR.4 and SR.5 to “1”. Successful block erase requires that the corresponding block lock-bits is not set. If the host attempts a block erase when the corresponding block lock-bit is set, the WSM will set SR.1 and SR.5 to “1”.

8.6 Word Write Command

The host executes a word write by a two-cycle command sequence. The host writes word write setup (standard 4040H or alternate 1010H) first, followed by a second write that specifies the address and data (latched on the rising edge of WE#). The WSM then takes over, controlling the word write and write verify algorithms internally. After the host writes the word write sequence, the device automatically output status register data when read. The CPU can detect the completion of the byte write event by analyzing the BUSY# pin or status register bit SR.7.

When the WSM completes the word writes, the host should check status register bit SR.4. If the host detects a write error, it should clear the status register. The internal WSM verify only detects errors for “1”s that do not

successfully writes to “0”s. The CUI remains in read status register mode until it receives another command.

Successful word writes requires that the corresponding block lock-bit is not set. If the host attempts a write when the corresponding block lock-bit is set, the WSM will set SR.1 and SR.4 “1”.

8.7 Block Erase Suspend Command

The Block Erase Suspend command allows block-erase interruption to read or write data in another block of memory. Once the block erase process starts, writing the Block Erase Suspend command requests that the WSM suspend the block erase sequence at a predetermined point in the algorithm. After the host writes the Block Erase Suspend command, the host should then write the Read Status Register command. Polling status register bits SR.7 and SR.6 can determine when the WSM suspends the block erase operation (both will be set to “1”). BUSY# will also transition to V_{OH} . Specification t_{WHRH2} defines the block erase suspend latency. It is also possible that the block erase completes before the device has an opportunity to suspend. The host should also check for this condition.

After the block erase has been suspended, the host can issue a read array command or a word write command to any block except the one that has been suspended. Using the Word Write Suspend command (see Section 8.8), a word write operation can also be suspended. During a word write operation with block erase suspended, status register bit SR.7 will return to “0” and the BUSY# output will transition to V_{OL} . However, SR.6 will remain “1” to indicate block erase suspend status. The only other valid commands while block erase is suspended are Read Status Register and Block Erase Resume. After the host writes a Block Erase Resume command to the flash memory, the WSM will continue the block erase process. Status register bits SR.6 and SR.7 will automatically clear and BUSY# will return to V_{OL} . After the host writes the Erase Resume command, the device automatically outputs status register data when read. Block erase cannot resume until word write operation initiated during block erase suspend have completed.

8.8 Word Write Suspend Command

The Word Write Suspend command allows word write interruption to read data in other flash memory locations. Once the word write process starts, writing the Word Write Suspend command requests that the WSM suspend the word write sequence at a predetermined point in the algorithm. After the host writes the Word Write Suspend command, it should write the Read Status Register command. Polling status register bits SR.7 and SR.2 can determine when the WSM suspends the byte write operation (both will be set to “1”). BUSY# will also transition to V_{OH} . Specification t_{WHRH1} defines the word write suspend latency. It is also possible that the word write completes before the device has an opportunity to suspend. The host should also check for this condition.

After the word write has been suspended, the host can write the Read Array command to read data from any location except the suspended location. The only other valid commands while word write is suspended are Read Status Register and Word Write Resume. After the host writes a Word Write Resume to the CUI, the WSM will continue the word write process. Status register bits SR.2 and SR.7 will automatically clear and BUSY# will return to V_{OL} . After the host writes the Word Write Resume command, the device automatically outputs status register data when read.

8.9 Set Block Lock-Bit Command

The host can enable a flexible block locking and unlocking scheme using the Set Block Lock-Bit command. This command enables the host to lock individual blocks within the flash array. The block lock-bits gate program and erase operations.

The host sets the block lock-bit using a two-cycle command sequence. The host writes the set block lock-bit setup command along with the appropriate block or device address. This command is followed by the set block lock-bit confirm command (and an address within the block to be locked). The WSM controls the set lock-bit algorithm. After the host completes the command sequence, the card automatically outputs status register data when read. The CPU can detect the completion of the set lock-bit event by analyzing the BUSY# pin output or status register bit SR.7.

When the WSM completes the set lock-bit operation, the host should check status register bit SR.4. If the host detects an error it should clear the status register. The CUI will remain in read status register mode until the host issues a new command.

This two-step sequence of set-up followed by execution ensures that the host does not accidentally set the lock-bits. An invalid Set Block Lock-Bit command will result in the WSM setting status register bits SR.4 and SR.5 to "1".

8.10 Clear Block Lock-Bits Command

The host clears all set block lock-bits in parallel using the Clear Block Lock-Bits command. The host is free to clear block lock-bits using the Clear Block Lock-Bits command.

The host executes the clear block lock-bits operation using a two-cycle command sequence. The host must first issue a Clear Block Lock-Bits setup command. This command is followed by a confirm command. After the host completes the two-cycle command sequence, the device automatically outputs status register data when read. The CPU can detect completion of the clear block lock-bits event by analyzing the BUSY# pin output or status register bit SR.7.

When the WSM completes the operation, the host should check status register bit SR.5. If the host detects a clear block lock-bit error, the host should clear the status register. The CUI will remain in read status register mode until the host issues another command.

This two-step sequence of set-up followed by execution ensures that the host does not accidentally clear block lock-bits. An invalid Clear Block Lock-Bits command sequence will result in the WSM setting status register bits SR.4 and SR.5 to "1".

If a clear block lock-bits operation is aborted due to V_{CC} transitioning out of valid range or RESET# active transition, block lock-bit values are left in an undetermined state. The host must repeat the clear block lock-bits command to initialize block lock-bit contents to known values.

8.11 Status Register

The memory devices in this card have Status Register which shows state of the device.

Byte Access × 8 Bits

bit7	bit6	bit5	bit4	bit3	bit2	bit1	bit0
SR. 7	SR. 6	SR. 5	SR. 4	SR. 3	SR. 2	SR. 1	SR. 0
WSMS	ESS	ECLBS	BWSLBS	VPPS	BWSS	DPS	RFU

Table 4. Status Register Definition

<p>SR. 7 = WRITE STATE MACHINE STATUS 1 = Ready 0 = Busy</p> <p>SR. 6 = ERASE SUSPEND STATUS 1 = Block Erase Suspended 0 = Block Erase in Progress/Completed</p> <p>SR. 5 = ERASE AND CLEAR LOCK-BITS STATUS 1 = Error in Block Erasure or Clear Lock-Bits 0 = Successful Block Erase or Clear Lock-Bits</p> <p>SR. 4 = BYTE WRITE AND SET LOCK-BIT STATUS 1 = Error in Byte Write or Set Block Lock-Bit 0 = Successful Byte Write or Set Block Lock-Bit</p> <p>SR. 3 = V_{PP} STATUS 1 = V_{PP} Low Detect, Operation Abort 0 = V_{PP} OK</p> <p>SR. 2 = BYTE WRITE SUSPEND STATUS 1 = Byte Write Suspended 0 = Byte Write in Progress/Completed</p> <p>SR. 1 = DEVICE PROTECT STATUS 1 = Block Lock-Bit and/or RP# Lock Detected, Operation Abort 0 = Unlock</p> <p>SR. 0 = RESERVED FOR FUTURE ENHANCEMENTS</p>	<p>NOTES: Check BUSY# or SR.7 to determine block erase, byte write, or lock-bit configuration completion. SR.6-0 are invalid while SR.7 = "0".</p> <p>If both SR.5 and SR.4 are "1"s after a block erase or lock-bit configuration attempt, an improper command sequence was entered.</p> <p>SR.3 indicates the V_{PP} status. However, the Miniature Card internally ties V_{PP} to V_{CC} so this bit should not be set to "1". If for some reason this bit is set, the host should write the Clear Status Register command.</p> <p>SR.1 does not provide a continuous indication of block lock-bit values. The WSM interrogates the block lock-bit, and RP# only after Block Erase, Byte Write, or Lock-Bit configuration command sequences. It informs the system, depending on the attempted operation, if the block lock-bit is set, and/or RP# is not V_{HH}. Reading the block lock configuration codes after writing the Read Identifier Codes command indicates block lock-bit status.</p> <p>SR.0 is reserved for future use and should be masked out when polling the status register.</p>
--	---

Word Access × 16 bits

bit15								bit8	bit7	bit0						
SR.15	SR.14	SR.13	SR.12	SR.11	SR.10	SR.9	SR.8	SR.7	SR.6	SR.5	SR.4	SR.3	SR.2	SR.1	SR.0	

High Byte device

Low Byte device

8.12 Automated Word Write Flowchart

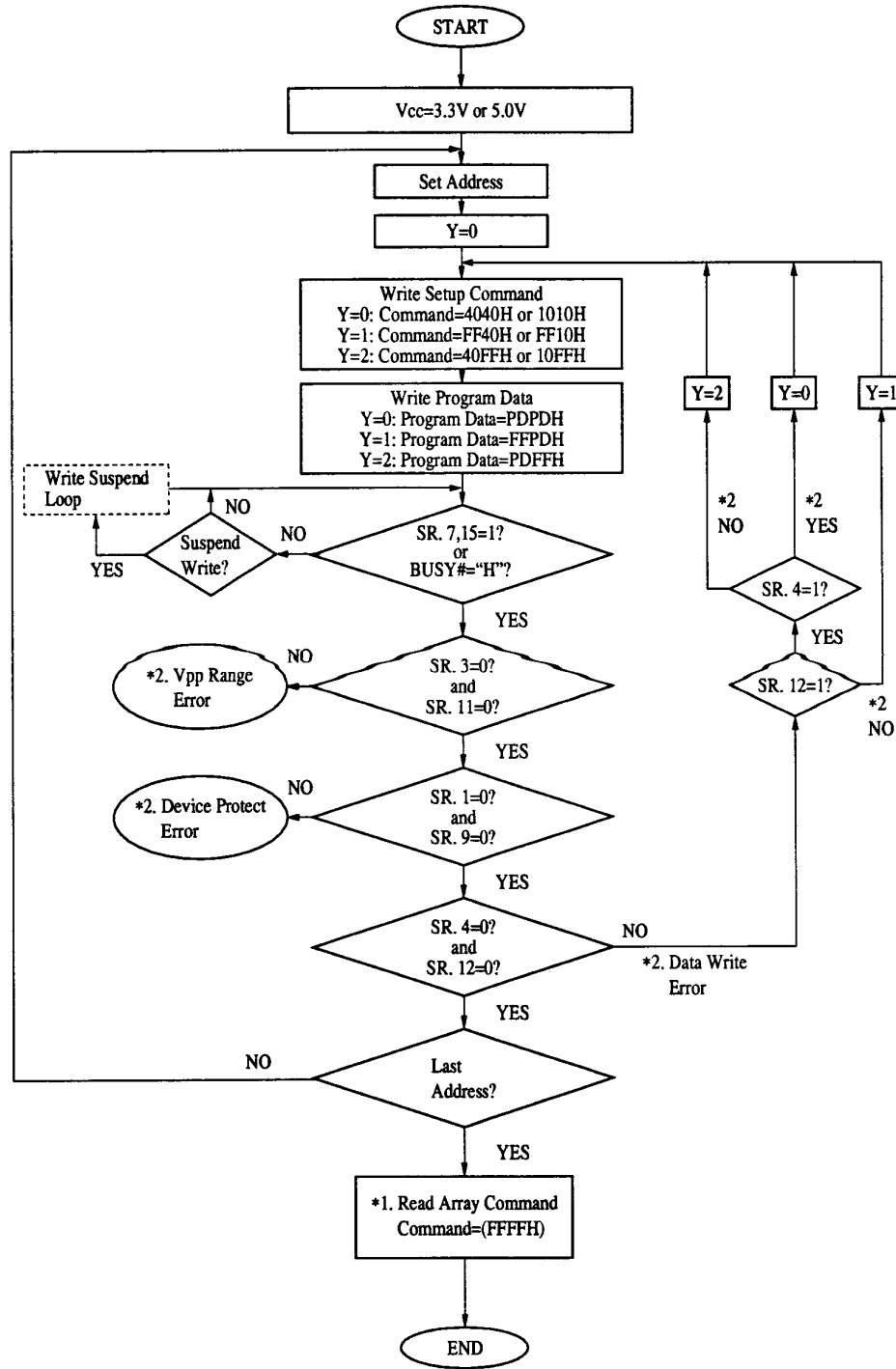

Note) *1. Write FFFFH after the last word write operation to reset the device to Read Array Mode.

*2. If error is detected, clear the Status Register before attempting retry or other error recovery.

8.13 Automated Block Erase Flowchart

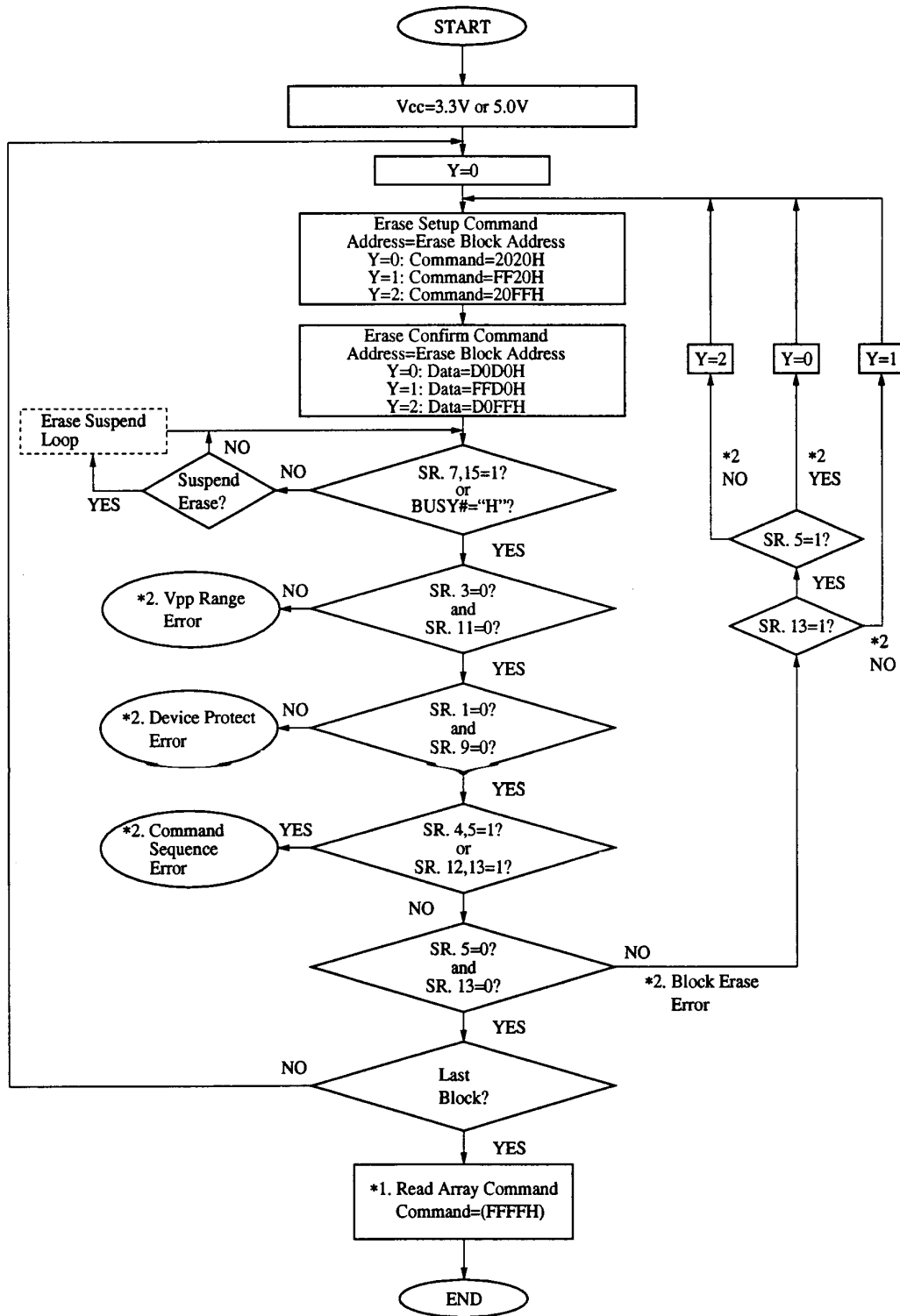

Note) *1. Write FFFFH after the last block erase operation to reset the device to Read Array Mode.

*2. If error is detected, clear the Status Register before attempting retry or other error recovery.

9. Electrical Specifications

9.1 Absolute Maximum Ratings

PARAMETER	SYMBOL	RATING	UNIT
Supply Voltage ⁽²⁾	V _{CC}	-0.2 to 7.0	V
Input Voltage ⁽²⁾	V _{IN}	-0.5 to V _{CC} + 0.5 (Max: 7.0)	V
Output Short Circuit Current ⁽³⁾	I _{OUT}	100	mA
Operating Temperature ⁽¹⁾	T _{OPR}	0 to 60	°C
Storage Temperature	T _{STG}	-30 to 70	°C

NOTES:

- Operating temperature is for commercial product defined by this specification.
- All specified voltages are with respect to GND.
- Output shorted for no more than one second. No more than one output shorted at a time.

9.2 Recommended Operating Conditions

PARAMETER	SYMBOL	MINIMUM	MAXIMUM	UNIT
Operating Temperature	T _{OPR}	0	60	°C
Supply Voltage 1	V _{CC1}	3.0	3.6	V
Supply Voltage 2	V _{CC2}	4.75	5.25	V

9.3 Capacitance

T_a = 25°C, f = 1MHz

PARAMETER	SYMBOL	MIN	TYP	MAX	UNIT	CONDITION
Input Capacitance	C _{IN}	—	24	32	pF	V _{IN} = 0.0V
Input/Output Capacitance	C _{IO}	—	16	24	pF	V _{OUT} = 0.0V

9.4 AC Input/Output Test Conditions

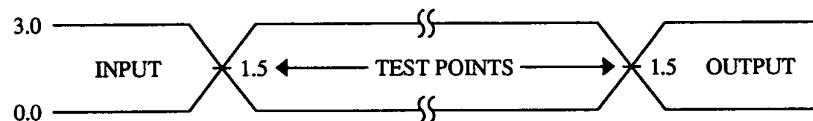

Figure 5. Transient Input/Output Reference Waveform for V_{CC} = 3.3V ± 0.3V and V_{CC} = 5.0V ± 5% (Standard Testing Configuration)

AC test inputs are driven at 3.0V for a Logic "1" and 0.0V for a Logic "0". Input timing begins, and output timing ends, at 1.5V. Input rise and fall times (10% to 90%) < 10ns.

10. DC Characteristics

(Ta = 0~60°C)

PARAMETER	SYMBOL	NOTES	V _{CC} = 3.3V		V _{CC} = 5.0V		UNIT	TEST CONDITIONS
			MIN	MAX	MIN	MAX		
Input Leakage Current (A0-A20)	I _{LI1}	1	—	±2	—	±4	μA	V _{CC} = V _{CC} Max, V _{IN} = V _{CC} or GND
Input Leakage Current (A21)	I _{LI2}	1	-1	40	-1	60	μA	V _{CC} = V _{CC} Max, V _{IN} = V _{CC} or GND
Input Leakage Current (CEL#,CEH#,RESET#)	I _{LI3}	1	-40	1	-60	1	μA	V _{CC} = V _{CC} Max, V _{IN} = V _{CC} or GND
Input Leakage Current (OE#,WE#)	I _{LI4}	1	-45	2	-65	4	μA	V _{CC} = V _{CC} Max, V _{IN} = V _{CC} or GND
Output Leakage Current (D0-D15)	I _{LO}	1	—	±1	—	±20	μA	V _{CC} = V _{CC} Max, V _{IN} = V _{CC} or GND
V _{CC} Standby Current	I _{CCS}	1, 3	—	480	—	480	μA	V _{CC} = V _{CC} Max, CEL#,CEH# = V _{CC} ± 0.2V, RESET# = V _{CC} ± 0.2V
V _{CC} Deep Power-Down Current	I _{CCD}	1, 3	—	120	—	135	μA	RESET# = GND ± 0.2V, I _{OUT} (BUSY#)=0 mA
V _{CC} Read Current	I _{CCR}	1, 3, 4, 5	—	25	—	70	mA	V _{CC} = V _{CC} Max, CEL#,CEH# = GND ± 0.2V, t _{cycle} = 150ns @ 3.3V, t _{cycle} = 150ns @ 5.0V, I _{OUT} = 0 mA
V _{CC} Word Write or Set Lock-Bit Current	I _{CCW}	1, 5	—	115	—	150	mA	
V _{CC} Block Erase or Clear Lock-Bit Current	I _{CCCE}	1, 5	—	75	—	100	mA	
V _{CC} Word Write or Block Erase Suspend Current	I _{CCWS} I _{CCES}	1, 2, 5	—	12	—	20	mA	CEL# = CEH# = V _{IH}

PARAMETER	SYMBOL	NOTES	V _{CC} = 3.3V		V _{CC} = 5.0V		UNIT	TEST CONDITIONS
			MIN	MAX	MIN	MAX		
Input Low Voltage	V _{IL}		-0.5	0.8	-0.5	0.8	V	
Input High Voltage	V _{IH}		0.7V _{CC}	V _{CC} +0.5	0.7V _{CC}	V _{CC} +0.5	V	
Output Low Voltage	V _{OL}		—	0.1V _{CC}	—	0.1V _{CC}	V	V _{CC} = V _{CC} Min, I _{OL} = 4mA @ 5.0V, I _{OL} = 2mA @ 3.3V
Output High Voltage	V _{OH}		0.9V _{CC}	—	0.9V _{CC}	—	V	V _{CC} = V _{CC} Min I _{OH} = -100μA
V _{CC} Lockout Voltage	V _{LKO}		2.0	—	2.0	—	V	

NOTES:

- All currents are in RMS unless otherwise noted.
- I_{CCWS} and I_{CCES} are specified with the device de-selected. If read or byte written while in erase suspend mode, the device's current draw is the sum of I_{CCWS} or I_{CCES} and I_{CCR} or I_{CCW}, respectively.
- CMOS inputs are either V_{CC} ± 0.2V or GND ± 0.2V.
- Automatic Power Savings (APS) reduces typical I_{CCR} to 2mA at 5V V_{CC} and 6 mA at 3.3V V_{CC} in static operation (addresses not switching).
- All values are based on word accesses. Values for byte accesses are 50% of the specification listed.

11. AC Characteristics (Ta = 0~60°C)

Testing Conditions :

- 1) Input Pulse Level : 0.0V~3.0V
- 2) Input Rise/Fall Time : 10ns
- 3) Input/Output Timing Reference Level : 1.5V
- 4) Output Load : 30pF (including scope and jig capacitance)

11.1 Read Operations

(Ta = 0 ~ 60°C)

PARAMETER	SYMBOL	V _{CC} = 3.3V		V _{CC} = 5.0V		UNIT
		MIN	MAX	MIN	MAX	
Read Cycle Time	t _{AVAV}	150	—	150	—	ns
Address Access Time	t _{AVQV}	—	150	—	150	
Card Enable Access Time	t _{ELQV}	—	150	—	150	
Output Enable Access Time	t _{GLQV}	—	50	—	50	
Output Disable Time from CEL#/CEH#*	t _{EHQZ}	—	20	—	20	
Output Disable Time from OE#*	t _{GHQZ}	—	20	—	20	
Output Enable Time from CEL#/CEH#	t _{ELQNZ}	5	—	5	—	
Output Enable Time from OE#	t _{GLQNZ}	5	—	5	—	
Data Hold from Address	t _{AXQX}	0	—	0	—	
Data Hold from CEL#/CEH#	t _{EHQX}	0	—	0	—	
Data Hold from OE#	t _{GHQX}	0	—	0	—	
CE# Setup Time to OE# Active	t _{ELGL}	0	—	0	—	
Address Setup Time to OE# Active	t _{AVGL}	0	—	0	—	
Power-Down Recovery to Output Delay	t _{PHQV}	—	600	—	400	

* Time until output becomes floating. (The output voltage is not defined.)

11.2 AC Waveforms for Read Operations

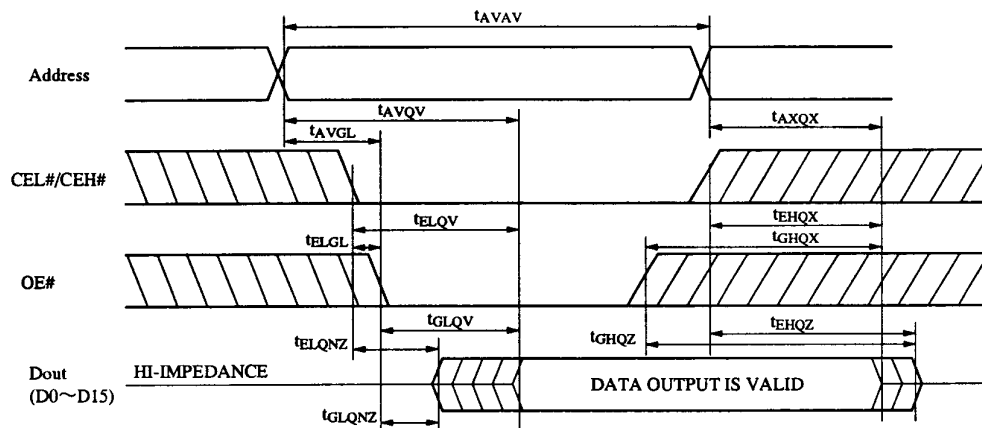

- Note) 1. WE# = "HIGH", during a read cycle.
 2. Either "HIGH" or "LOW" in diagonal areas.
 3. The output data becomes valid when last interval, t_{AXQV}, t_{ELQV} or t_{GLQV} have concluded.

11.3 Write Operations

11.3.1 WE# Controlled Write Operations

(Ta = 0~60°C)

PARAMETER	SYMBOL	V _{CC} = 3.3V		V _{CC} = 5.0V		UNIT
	IEEE	MIN	MAX	MIN	MAX	
Write Cycle Time	t _{AVAV}	150	—	150	—	ns
Address Setup Time	t _{AVWL}	20	—	20	—	
Write Recovery Time	t _{WHAX}	5	—	5	—	
Data Setup Time for WE#	t _{DVWH}	50	—	50	—	
Data Hold Time	t _{WHDX}	20	—	20	—	
Output Enable Hold from WE#	t _{WHGL}	10	—	10	—	
Card Enable Setup time for WE#	t _{ELWH}	100	—	100	—	
Address Setup for WE#	t _{AVWH}	100	—	100	—	
Write Pulse Width	t _{WLWH}	80	—	80	—	
WE# High to RDY/BSY# Going Low	t _{WHRL}	—	300	—	150	
Power-Down Recovery to WE# Going Low	t _{PHWL}	1	—	1	—	μs

11.3.2 CE# Controlled Write Operations

(Ta = 0~60°C)

PARAMETER	SYMBOL	V _{CC} = 3.3V		V _{CC} = 5.0V		UNIT
	IEEE	MIN	MAX	MIN	MAX	
Write Cycle Time	t _{AVAV}	150	—	150	—	ns
Address Setup Time	t _{AVEL}	20	—	20	—	
Write Recovery Time	t _{EHAX}	20	—	20	—	
Data Setup Time for CE#	t _{DVEH}	50	—	50	—	
Data Hold Time	t _{EHDX}	20	—	20	—	
Output Enable Hold from CE#	t _{EHGL}	10	—	10	—	
Write Enable Setup time for CE#	t _{WLEH}	100	—	100	—	
Address Setup for CE#	t _{AVEH}	100	—	100	—	
Card Enable Pulse Width	t _{LEH}	80	—	80	—	
CE# High to RDY/BSY# Going Low	t _{EHRL}	—	300	—	150	
Power-Down Recovery to CE# Going Low	t _{PEHL}	1	—	1	—	μs

11.3.3 AC Waveforms for Write Operations (WE# Controlled)

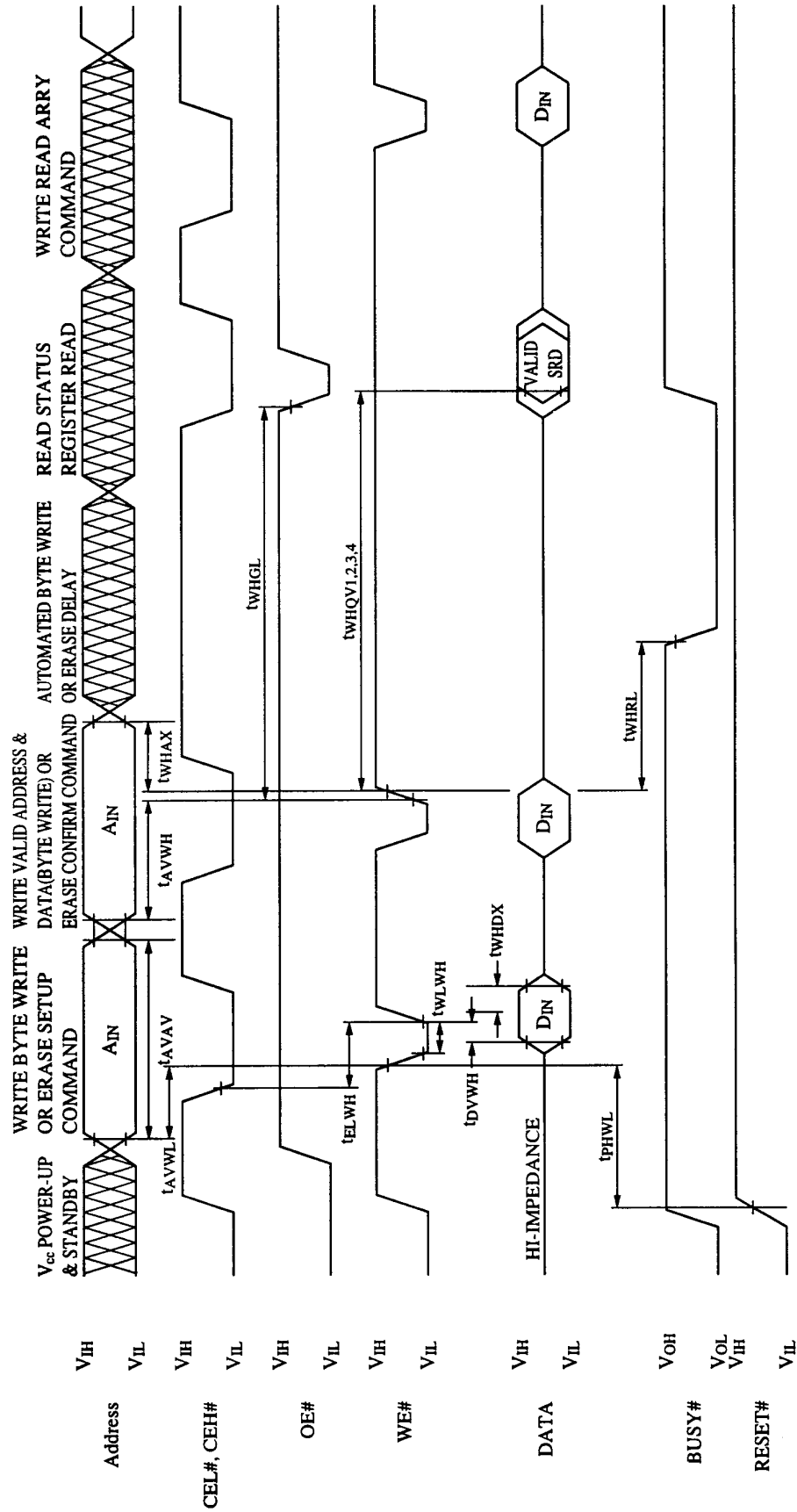

Note) While the data signal is in output mode, do not apply an opposite phase input signal.

11.3.4 AC Waveforms for Write Operations (CE# Controlled)

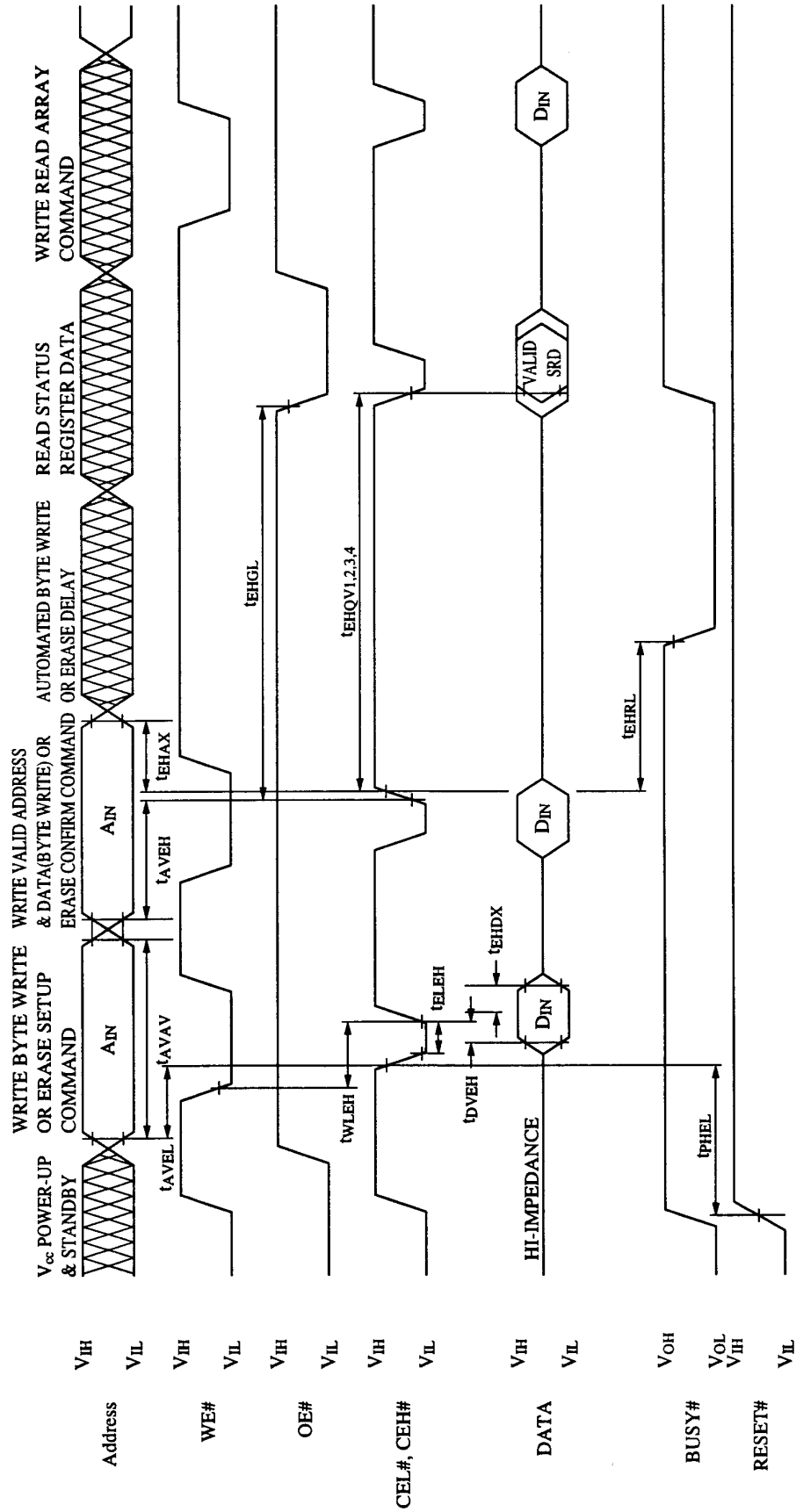

Note) While the data signal is in output mode, do not apply an opposite phase input signal.

11.4 Erase and Data Write Performance⁽³⁾

(Ta = 0~60°C)

PARAMETER	SYMBOL	NOTES	V _{CC} = 3.3V			V _{CC} = 5.0V			UNIT
			MIN	TYP ⁽¹⁾	MAX	MIN	TYP ⁽¹⁾	MAX	
Byte Write Time	t _{WHQV1}	2	—	17	300	—	8	150	μs
	t _{EHQV1}								
Block Write Time		2	—	1.1	4	—	0.5	1.5	s
Block Erase Time	t _{WHQV2}	2	—	0.8	6	—	0.4	5	s
	t _{EHQV2}								
Set Lock-Bit Time	t _{WHQV3}	2	—	21	—	—	12	—	μs
	t _{EHQV3}								
Clear Block Lock-Bits Time	t _{WHQV4}	2	—	1.8	—	—	1.1	—	s
	t _{EHQV4}								
Byte Write Suspend Latency Time to Read	t _{WHRH1}	—	—	7.1	10	—	5.6	7	μs
	t _{EHRH1}								
Erase Suspend Latency Time to Read	t _{WHRH2}	—	—	15.2	21.1	—	9.4	13.1	μs
	t _{EHRH2}								

NOTES:

1. Typical values measured at Ta = 25°C and nominal voltages. Assumes corresponding lock-bits are not set. Subject to change based on device characterization.
2. Excludes system-level overhead.
3. Sampled but not 100% tested.

11.5 Power-Up

PARAMETER	SYMBOL	NOTES	MIN	MAX	UNITS
CE# Setup Time	$t_{su}(\text{CEL\#/CEH\#})$	—	1	—	ms
RESET# Setup Time	$t_{su}(\text{RESET\#})$	—	1	—	ms
V _{CC} Rising Time	t_{pr}	1	0.1	100	ms
RESET# Width	$t_w(\text{RESET\#})$	—	1	—	μs

NOTES:

- The t_{pr} is defined as "linear waveform" in the period of 10% to 90%. Even if the waveform is not a "linear waveform," its rising time must meet this specification.

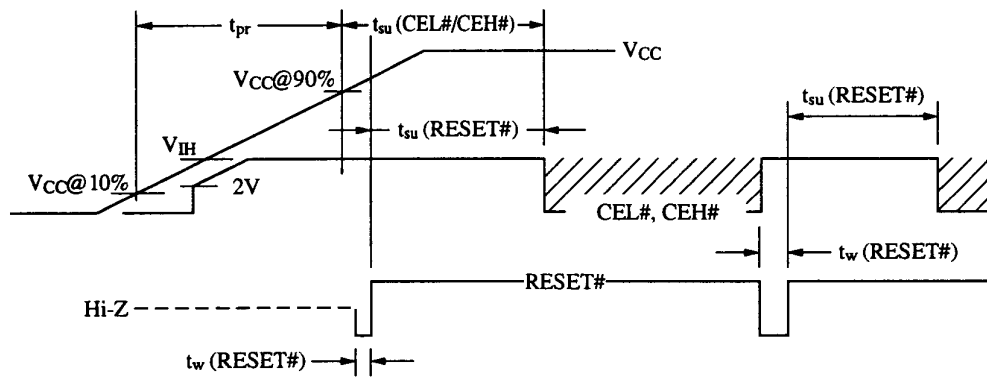

Power-Up Timing for Systems Supporting RESET#

12. Specification Changes

Specifications may be changed upon discussion and agreement between both parties.

13. Other Precautions

- Permanent damage occurs if the Miniature card is stressed beyond Absolute Maximum Ratings. Operation beyond the Recommended Operating Conditions is not recommended and extended exposure beyond the Recommended Operating Conditions may affect device reliability.
- Writing to the Miniature card can be prevented by switching on the write protect switch on the side of the Miniature card.
- Avoid allowing the Miniature card Pads to come in contact with metals and avoid touching the Pads, as the internal circuits can be damaged by static electricity.
- Avoid storing in direct sunlight, high temperatures (do not place near heaters or radiators), high humidity and dusty areas.
- Avoid subjecting the Miniature card to strong physical abuse. Dropping, bending, smashing or throwing the card can result in loss of function.
- When the Miniature card is not being used, return it to its protective case.
- Do not allow the Miniature card to come in contact with fire.

14. External Dimensions

Topside

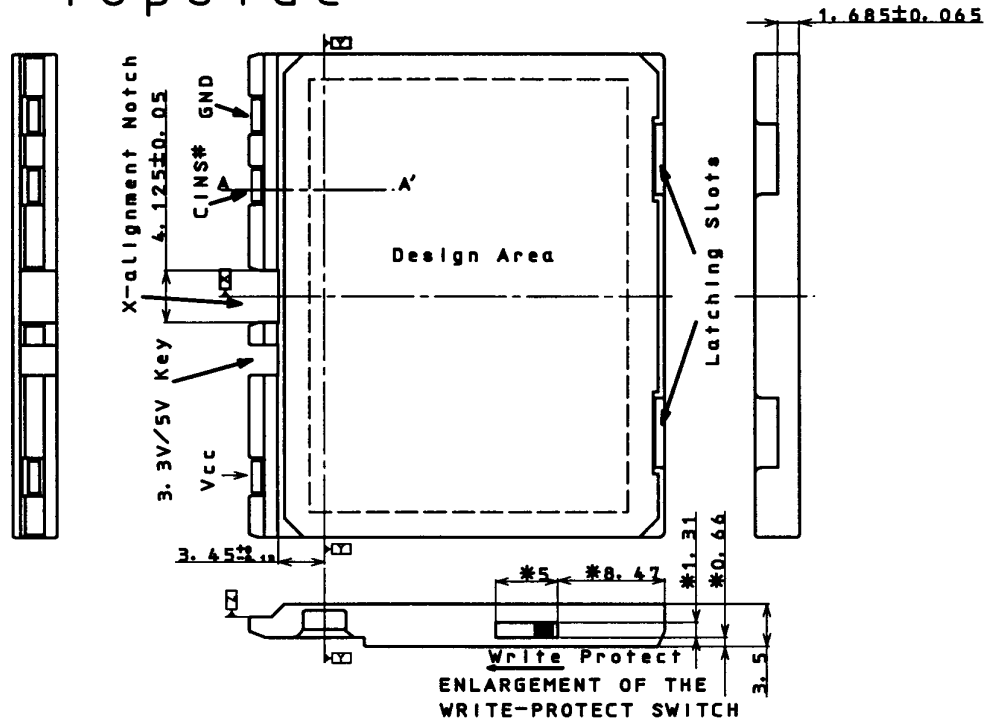

Bottomside

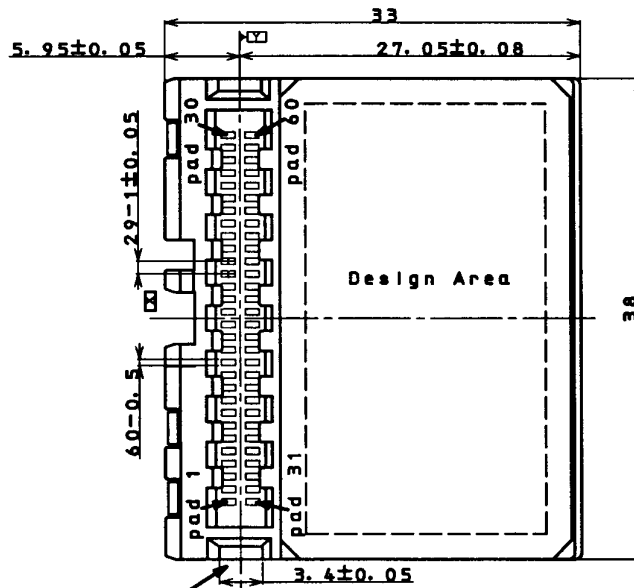

SECTION A-A'

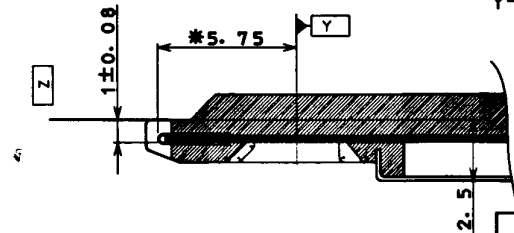

Y-alignment Notch

APPLICABLE		SCALE	UNIT	$\frac{\Delta}{\Delta}$		
			mm		CH. DATE	REVISE
THICKNESS	TOLERANCES	MATERIAL	FINISH		NAME	Miniature Card External Dimensions
	DECIMALS . XX =±0.13 *X. XX=±0.25					Miniature Card Release 1.1
DATE	1998.12.25	Image Device Engineering Dept. 2			DRAWING NO.	IMC122-A100
<i>F. Tanaka</i> <i>H. Kubota</i> <i>H. Tanaka</i>		TENRI IC GROUP				
		SHARP CORPORATION				

15. Packing Specification

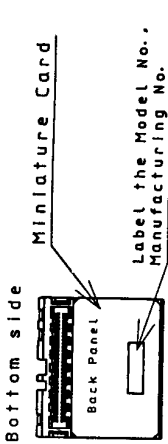

Note 4

Parts List

Parts Name
A Flexible Plastic Bag
B Inner Carton (100 pieces contained)
C Outer Carton (500 pieces contained)
D Outer Case (1000 pieces contained)

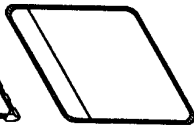

Flexible Plastic Bag (A)



X100

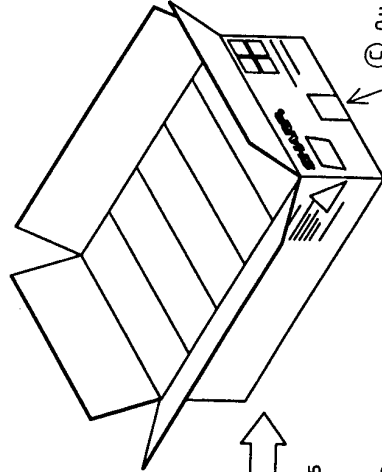

(B) Inner Carton (100 pieces contained)

Note 1

X5

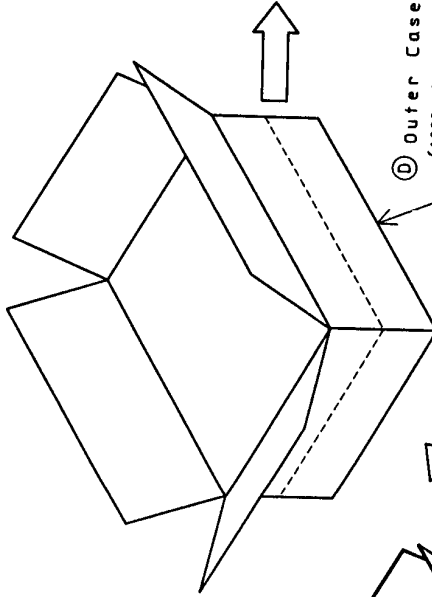

(D) Outer Case (1000 pieces contained)

Note 3

Packing Specification

- Label on which the Model No. and Manufacturing No. are printed is attached on the back panel of the card.
- Each Miniature Card is contained in the Flexible plastic bag. (The terminals of the card come to opposite side of the place where the card is released from the bag, so that the terminals are not touched by finger, as shown in the figure.)
- The inner carton contains 100 pieces of the card. (Note 1.)
- The product name, lot no. (product no.), quantity and the date are either written directly on the inner carton or printed on the label which is attached on inner carton.
- The outer carton contains 5 inner cartons. (Note 2.)
- The product name, lot no. (product no.), quantity and the date are either written directly on the outer carton or printed on the label which is attached on the outer carton.
- The outer carton is put into the outer case, which contains 2 outer cartons. (Note 3.)
- The product name, lot no. (product no.), quantity and the date are either written directly on the case or printed on the label which is attached on the case.

Note 1. The least packing unit is 100 pieces, which is the number contained in the inner carton.

Note 2. The inner space of the outer carton is filled with card boards.

Note 3. Other size of outer case may be used if there is not enough quantity to fill the normal outer case which can contain 2 outer cartons.

Note 4. The size and descriptions of the label on the back panel of the card are follows. (Unit:mm)

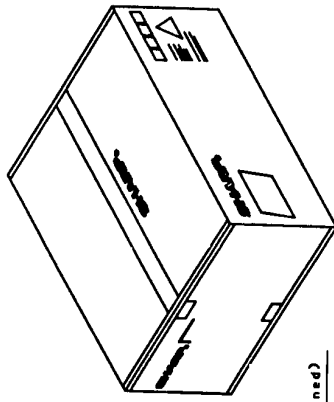
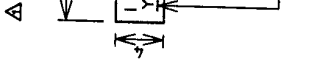

APPLICABLE MODEL	SCALE	UNIT	A	REVISION	H. T.
ID341G01 <td>mm</td> <td>mm</td> <td> </td> <td> </td> <td> </td>	mm	mm			
THICKNESS	DIFFERENCE	MATERIAL	FINISH	REVISION	CHARGE
DATE	1998.12.25				
NAME		ID341G01 Packing Specification			
DRAWING NO.		IMC122-J301			

DESIGNED BY: H. H. (Signature)
 CHECKED BY: H. H. (Signature)
 INTERESTED CIRCUITS GROUP: SHARP CORPORATION

SHARP

16. External Appearances

Topside

Bottomside

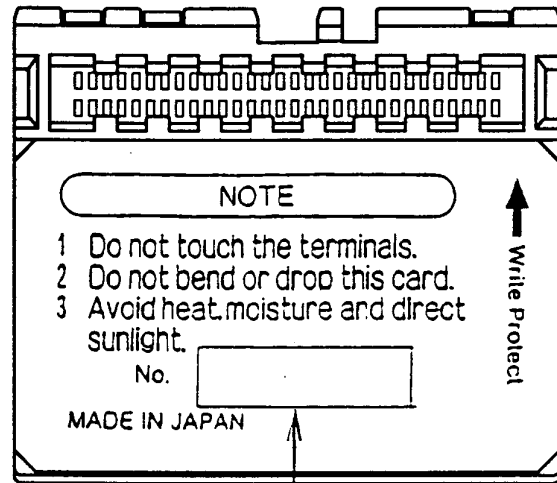

Labeling position

Miniature Card Logo	Blue
Capacitor	Yellow
Mark SHARP Logo	Black
Design	Refer to above figure

Characters on panel	Black
Characters on label	Black
Design	Refer to above figure

Flame : Black

Label size and Denotations

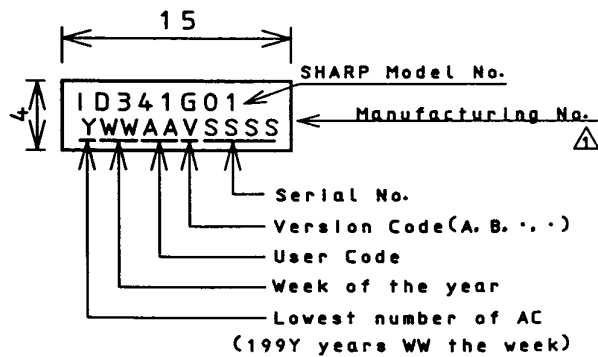

APPLICABLE MODEL	ID341G01	SCALE	2/1	UNIT	mm	1998.12.25	Manufacturing No. Change	H. T.
THICKNESS	DIFFERENCE	MATERIAL	FINISH	NAME	Miniature Card External Appearances ID341G01			
DATE	1998.12.25	Image Device Engineering Dept. 2			DRAWING NO.	IMC122-G101		
H. <i>Fukuda</i> H. <i>Janaka</i>		INTEGRATED CIRCUITS GROUP			SHARP CORPORATION			

Miniature Cards, Flash, PCMCIA, 8 MByte, Linear, ID341G01

SPECIFICATIONS ARE SUBJECT TO CHANGE WITHOUT NOTICE.

Suggested applications (if any) are for standard use; See Important Restrictions for limitations on special applications. See Limited Warranty for SHARP's product warranty. The Limited Warranty is in lieu, and exclusive of, all other warranties, express or implied. ALL EXPRESS AND IMPLIED WARRANTIES, INCLUDING THE WARRANTIES OF MERCHANTABILITY, FITNESS FOR USE AND FITNESS FOR A PARTICULAR PURPOSE, ARE SPECIFICALLY EXCLUDED. In no event will SHARP be liable, or in any way responsible, for any incidental or consequential economic or property damage.

SHARP®

NORTH AMERICA

SHARP Microelectronics
of the Americas
5700 NW Pacific Rim Blvd.
Camas, WA 98607, U.S.A.
Phone: (360) 834-2500
Fax: (360) 834-8903
<http://www.sharpsma.com>

EUROPE

SHARP Microelectronics Europe
Sonninstraße 3
20097 Hamburg, Germany
Phone: (49) 40 2376-2286
Fax: (49) 40 2376-2232
<http://www.sharpsme.com>

ASIA

SHARP Corporation
Integrated Circuits Group
2613-1 Ichinomoto-Cho
Tenri-City, Nara, 632, Japan
Phone: +81-743-65-1321
Fax: +81-743-65-1532
<http://www.sharp.co.jp>

SPECIFICATIONS ARE SUBJECT TO CHANGE WITHOUT NOTICE.

Suggested applications (if any) are for standard use; See Important Restrictions for limitations on special applications. See Limited Warranty for SHARP's product warranty. The Limited Warranty is in lieu, and exclusive of, all other warranties, express or implied. ALL EXPRESS AND IMPLIED WARRANTIES, INCLUDING THE WARRANTIES OF MERCHANTABILITY, FITNESS FOR USE AND FITNESS FOR A PARTICULAR PURPOSE, ARE SPECIFICALLY EXCLUDED. In no event will SHARP be liable, or in any way responsible, for any incidental or consequential economic or property damage.

SHARP®

NORTH AMERICA

SHARP Microelectronics
of the Americas
5700 NW Pacific Rim Blvd.
Camas, WA 98607, U.S.A.
Phone: (360) 834-2500
Fax: (360) 834-8903
<http://www.sharpsma.com>

EUROPE

SHARP Microelectronics Europe
Sonninstraße 3
20097 Hamburg, Germany
Phone: (49) 40 2376-2286
Fax: (49) 40 2376-2232
<http://www.sharpsme.com>

ASIA

SHARP Corporation
Integrated Circuits Group
2613-1 Ichinomoto-Cho
Tenri-City, Nara, 632, Japan
Phone: +81-743-65-1321
Fax: +81-743-65-1532
<http://www.sharp.co.jp>