

T-77-11

# LR3715M Remote Control Transmitter LSI

## Description

The LR3715M is a CMOS LSI developed for use in infrared remote control transmitters.

## Features

1. 56-channel of data can be transmitted
2. Transmission code : PPM
3. Time base : 455kHz ceramic oscillator
4. Supply voltage : 3V
5. CMOS process
6. 36-pin quad-flat package

## Pin Connections

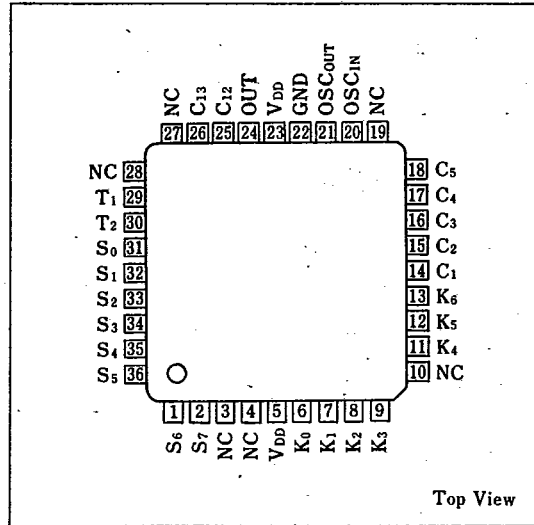

## Block Diagram

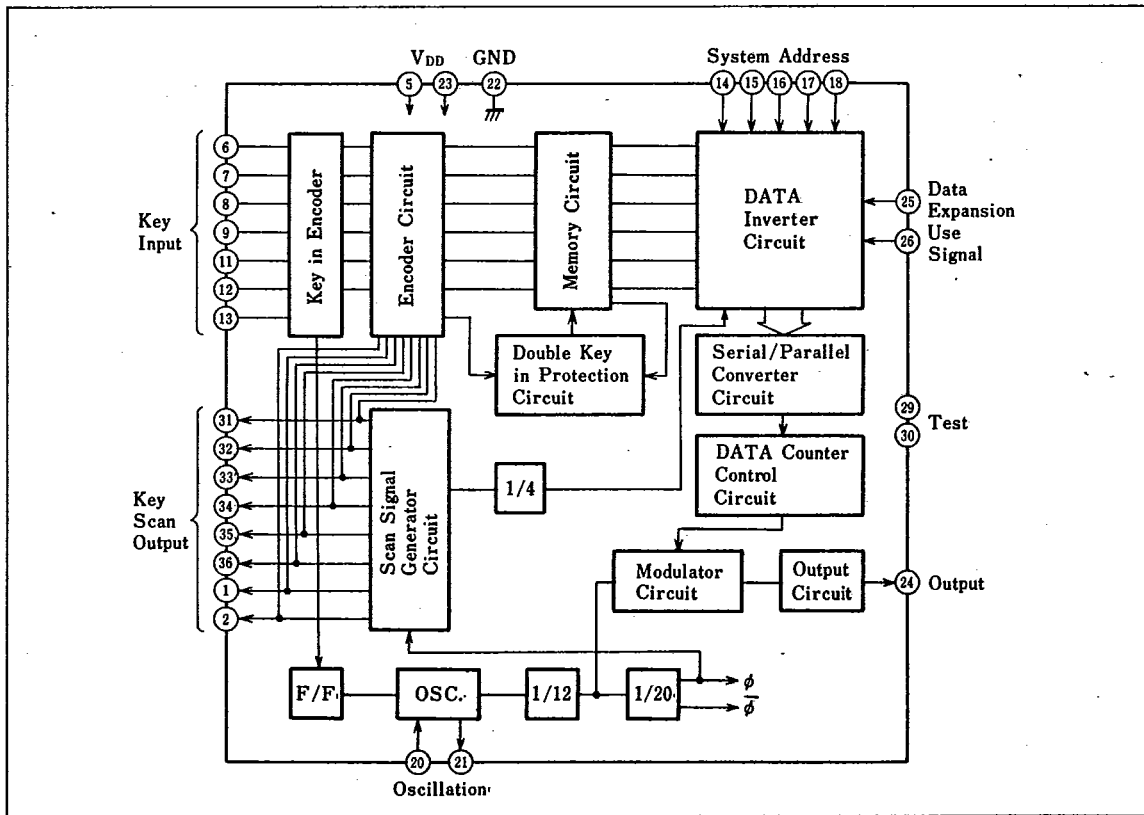

### Absolute Maximum Ratings

Parameter	Symbol	Conditions	Rating	Unit	Note
Supply voltage	V <sub>DD</sub>	Referenced to GND	-0.3 to +6	V	
Input voltage	V <sub>IN</sub>	Referenced to GND	-0.3 to +6	V	
Supply current	I <sub>DD</sub> , I <sub>EE</sub>		±5	mA	1,2
Output current	I <sub>OUT</sub>		±2	mA	2
Power consumption	P <sub>D</sub>	T <sub>a</sub> =25°C	483	mW	
Operating temperature	T <sub>opr</sub>		-20 to +70	°C	
Storage temperature	T <sub>stg</sub>		-50 to +125	°C	

Note 1: I<sub>DD</sub> refers to the current that flows into the V<sub>DD</sub> pin; I<sub>EE</sub> refers to the current draining from the GND pin.

Note 2: The direction of current flowing into the device is defined as positive; that draining from the device is defined as negative. This definition is also applied to the electrical characteristics.

### Recommended Operating Conditions

Parameter	Symbol	Conditions	MIN.	TYP.	MAX.	Unit
Supply voltage	V <sub>DD</sub>	Referenced to GND	2.2	3	3.3	V
Input voltage	V <sub>IN</sub>	Referenced to GND	0		V <sub>DD</sub>	V
Oscillator frequency	fosc			455		kHz

### Electrical Characteristics

(V<sub>DD</sub>=3V, T<sub>a</sub>=25°C)

Parameter	Symbol	Conditions	MIN.	TYP.	MAX.	Unit	Note
Supply voltage	V <sub>DD</sub>		2.2	3	3.3	V	1
Current consumption	I <sub>DD</sub>	All input pins open	fosc oscillated		0.5	mA	1
			fosc stopped		1	μA	
Input voltage	V <sub>IN</sub>		V <sub>DD</sub> -0.6		V <sub>DD</sub>	V	2
	V <sub>IL</sub>		0		0.6	V	3
Input current	I <sub>IH1</sub>	V <sub>IN</sub> =V <sub>DD</sub>			1	μA	2
	I <sub>IL1</sub>	V <sub>IN</sub> =GND			-1		
	I <sub>IH2</sub>	V <sub>IN</sub> =V <sub>DD</sub>			1	μA	3
	I <sub>IL2</sub>	V <sub>IN</sub> =GND			-150		
Output voltage	V <sub>OH1</sub>	I <sub>OH</sub> =-5 μA	V <sub>DD</sub> -0.4		V <sub>DD</sub>	V	4
	V <sub>OL1</sub>	I <sub>OL</sub> =400 μA	0		0.4		
	V <sub>OH2</sub>	I <sub>OH</sub> =-0.5mA	V <sub>DD</sub> -0.4		V <sub>DD</sub>	V	5
	V <sub>OL2</sub>	I <sub>OL</sub> =1mA	0		0.4		
Oscillator frequency	fosc			455		kHz	6
Feedback resistor	R <sub>b</sub>		1		5	MΩ	

Note 1: Applied to V<sub>DD</sub> pin.

Note 2: Applied to pins C<sub>1</sub>-C<sub>5</sub>, C<sub>12</sub> and C<sub>13</sub>.

Note 3: Applied to pins K<sub>0</sub>-K<sub>6</sub>, T<sub>1</sub> and T<sub>2</sub>.

Note 4: Applied to pins S<sub>0</sub>-S<sub>7</sub>.

Note 5: Applied to OUT pin.

Note 6: Applied to pins OSC<sub>IN</sub> and OSC<sub>OUT</sub>.

Remote Control Transmitter LSI

LR3715M

T-77-11

Functions

(1) Transmission scheme

The LR3715M uses the PPM (pulse position modulation) system for 15-bit signal.

The device alternately transmits non-inverted 15-bit data and inverted 15-bit data (system-address bit 5 is not inverted, however). The receiver re-inverts the inverted data into the original form and compares it with the preceding non-inverted data to be sure the two pieces of data are identical. Discrimination between inverted and non-inverted is achieved by checking the judging bit. Reception becomes valid only after the data pieces prove identical.

The PPM system arranges pulses as follows to discriminate logic "1" from "0".

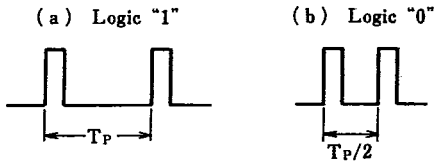

If the interval between two pulses is  $T_p$ , the signal is identified to be logic "1", whereas if it is  $T_p/2$ , the signal is identified to be "0". The device thus constructs 15-bit serial data as follows. For example, a binary code "000010001000000" is converted into a pulse array as follows:

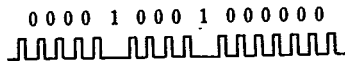

The following shows bit assignments to data:

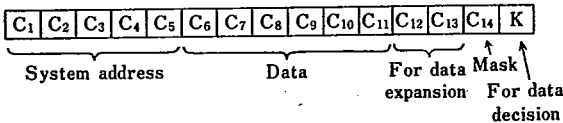

① System address C<sub>1</sub>-C<sub>5</sub> These bits are set up with switch and allocated to different system. Up to 56 types of commands and two expansion bit can be transmitted for each system. For system address allocation, be sure to contact us.

② Data code C<sub>6</sub>-C<sub>11</sub> The Data code C<sub>6</sub>-C<sub>11</sub> are allocated to key numbers as shown in the following table:

CH	C <sub>6</sub>	C <sub>7</sub>	C <sub>8</sub>	C <sub>9</sub>	C <sub>10</sub>	C <sub>11</sub>	CH	C <sub>6</sub>	C <sub>7</sub>	C <sub>8</sub>	C <sub>9</sub>	C <sub>10</sub>	C <sub>11</sub>
1	1	0	0	0	0	0	29	1	0	1	1	1	0
2	0	1	0	0	0	0	30	0	1	1	1	1	0
3	1	1	0	0	0	0	31	1	1	1	1	1	0
4	0	0	1	0	0	0	32	0	0	0	0	0	1
5	1	0	1	0	0	0	33	1	0	0	0	0	1
6	0	1	1	0	0	0	34	0	1	0	0	0	1
7	1	1	1	0	0	0	35	1	1	0	0	0	1
8	0	0	0	1	0	0	36	0	0	1	0	0	1
9	1	0	0	1	0	0	37	1	0	1	0	0	1
10	0	1	0	1	0	0	38	0	1	1	0	0	1
11	1	1	0	1	0	0	39	1	1	1	0	0	1
12	0	0	1	1	0	0	40	0	0	0	1	0	1
13	1	0	1	1	0	0	41	1	0	0	1	0	1
14	0	1	1	1	0	0	42	0	1	0	1	0	1
15	1	1	1	1	0	0	43	1	1	0	1	0	1
16	0	0	0	0	1	0	44	0	0	1	1	0	1
17	1	0	0	0	1	0	45	1	0	1	1	0	1
18	0	1	0	0	1	0	46	0	1	1	1	0	1
19	1	1	0	0	1	0	47	1	1	1	1	0	1
20	0	0	1	0	1	0	48	0	0	0	0	1	1
21	1	0	1	0	1	0	49	1	0	0	0	1	1
22	0	1	1	0	1	0	50	0	1	0	0	1	1
23	1	1	1	0	1	0	51	1	1	0	0	1	1
24	0	0	0	1	1	0	52	0	0	1	0	1	1
25	1	0	0	1	1	0	53	1	0	1	0	1	1
26	0	1	0	1	1	0	54	0	1	1	0	1	1
27	1	1	0	1	1	0	55	1	1	1	0	1	1
28	0	0	1	1	1	0	56	0	0	0	1	1	1

③ Data expansion bits C<sub>12</sub>, C<sub>13</sub> These bits are used to increase available command types.

④ Data judging bit K This bit K is unique to Sharp's remote control system, and is used to indicate whether the preceding data is inverted or non-inverted:

(a) Non-inverted data



(b) Inverted data

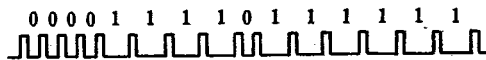

When the data judging bit is set to zero, the device transmits non-inverted data. When it is set to one, the device transmits inverted data (inversion of C<sub>6</sub>-C<sub>14</sub> and K).



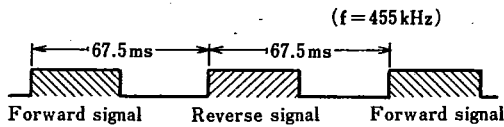

As shown in the above figure, the non-inverse and inverse signals alternately repeat in series at a certain interval. The receiver reconstructs the original data by identifying non-inverse or inverse signal according to the status of the data judging bit.

⑤ Mask bit  $C_{14}$  Fixed at "0" (low) within the device

**(2) Device operation timing**

The LR3715M is a transmitter LSI device designed for use in an infrared remote control unit. It consists of an oscillator, key scan signal generator, key encoder, memory, data inverter, parallel/serial converter, and output circuit. The device can accept a 7x8 key matrix and transmit up to 56 types of commands in 6-bit code. For power saving, the internal oscillation is stopped when no key is pressed. If double key operation is made, the device stops transmission.

① Key scan signal generator When a key entry is made, a flip-flop reverses its status to reset the Oscillation Clear signal and start internal oscillation. The key scan outputs provide the signals shown below. Given  $f_0 = 455 \text{ kHz}$ , the pulse period is 33.8 ms, and pulse width is 4.2 ms.

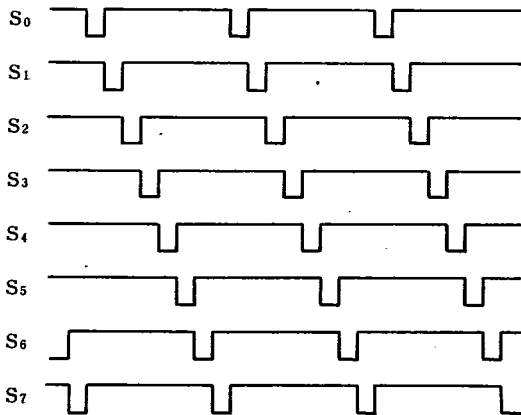

② Key encoder, encoder, and memory The key scan signal lines are combined with key input lines,  $K_0-K_6$ , to produce a 7x8 key matrix external to the device. The  $K_0-K_6$  input pins have built-in pull-up resistors.

If a key at the matrix point,  $K_1-S_3$ , is pressed,

the signal output at pin  $S_3$  is input to pin  $K_1$ , to be encoded into a 6-bit binary code by the key encoder and encoder before storage into memory. If two keys are pressed at the same time, the double key prevention logic clears the data in the pertinent location of the memory. The following table shows the key arrangement and command numbers. If one desires to transmit command number 3, the key at the matrix point,  $K_0-S_2$ , can be pressed.

	$S_0$	$S_1$	$S_2$	$S_3$	$S_4$	$S_5$	$S_6$	$S_7$
$K_0$								
$K_1$								
$K_2$								
$K_3$								
$K_4$								
$K_5$								
$K_6$								

		Scan signal							
		$S_0$	$S_1$	$S_2$	$S_3$	$S_4$	$S_5$	$S_6$	$S_7$
Key input	$K_0$	1	2	3	4	5	6	7	8
	$K_1$	9	10	11	12	13	14	15	16
	$K_2$	17	18	19	20	21	22	23	24
	$K_3$	25	26	27	28	29	30	31	32
	$K_4$	33	34	35	36	37	38	39	40
	$K_5$	41	42	43	44	45	46	47	48
	$K_6$	49	50	51	52	53	54	55	56

③ Data inverter If the 6-bit data is identified to be correct, it is transferred to the data inverter, where system address, data expansion bit, mask bit, and data judging bit are added to it to generate 15-bit data.

If the data judging bit is zero, the following data will be produced in the data inverter.

(Example) When the key numbered 8 is pressed:

$C_1$	$C_2$	$C_3$	$C_4$	$C_5$	$C_6$	$C_7$	$C_8$	$C_9$	$C_{10}$	$C_{11}$	$C_{12}$	$C_{13}$	$C_{14}$	K
0	0	0	0	1	0	0	0	1	0	0	0	0	0	0

If the data judging bit is "1", the data except for the system address, is inverted by the inverter.

$C_1$	$C_2$	$C_3$	$C_4$	$C_5$	$C_6$	$C_7$	$C_8$	$C_9$	$C_{10}$	$C_{11}$	$C_{12}$	$C_{13}$	$C_{14}$	K
0	0	0	0	1	1	1	1	0	1	1	1	1	1	1

The parallel 15-bit signal is then converted into serial PPM signal by the parallel/serial converter.

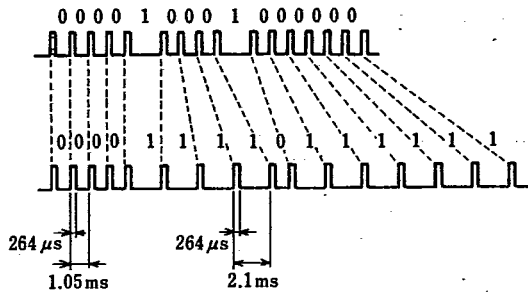

④ Modulator circuit While it is possible to transmit serial 15-bit PPM signals directly, it causes the broadening of occupied bandwidth. To prevent this, the device samples the 15-bit PPM signal with a 37.9 kHz (When  $f_0=455\text{kHz}$ ) signal and transmits PPM signal at 100% amplitude modulation.

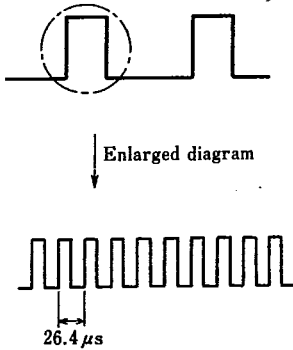

(3) Precautions in preparing a receiver

① Make sure that the non-inverse and inverse signals are transmitted alternately. Be sure to verify that bit number 15 (K) is alternately set to "1" and "0". It is not enough only to compare bits  $C_6-C_{14}$  either after inverting them or before inverting them.

② The PPM signal status "1" or "0" may be identified by checking its pulse interval as follows ( $f_0=455\text{ kHz}$ ):

- $T_P < 0.42\text{ ms}$  ... Incorrect signal
- $0.42\text{ ms} \leq T_P < 1.69\text{ ms}$  ... "0"
- $1.69\text{ ms} \leq T_P < 3.37\text{ ms}$  ... "1"
- $3.37\text{ ms} \leq T_P$  ... Incorrect signal

If a non-PPM signal is received, the device clears all bits and begins processing with the first bit again.

③ If 16 bits (17 pulses) or more of PPM signal are received, the device identifies it as a non-PPM signal, clears all bits, and begins processing with the first bit again.

④ The correct data should be identified by matching the system addresses and data expansion bits of the transmitter and receiver.

■ System Configuration Example

