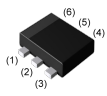
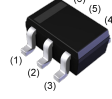
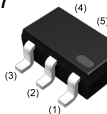

| Parameter | Tr1 and Tr2 |
|-----------|-------------|
| V_{CEO} | 50V |
| I_C | 150mA |

●Features

- 1) Two 2SC2412K chips in a EMT, UMT or SMT package.
- 2) Mounting possible with EMT3, UMT3 or SMT3 automatic mounting machines.
- 3) Transistor elements are independent, eliminating interference.
- 4) Mounting cost and area can be cut in half.

●Outline

| | |
|--|--|
| <p>SOT-563</p>  <p>EMX1 (EMT6)</p> | <p>SOT-363</p>  <p>UMX1N (UMT6)</p> |
| <p>SOT-457</p>  <p>IMX1 (SMT6)</p> | |

●Inner circuit

EMX1 / UMX1N

- (1) Tr1 Emitter
- (2) Tr1 Base
- (3) Tr2 Collector
- (4) Tr2 Emitter
- (5) Tr2 Base
- (6) Tr1 Collector

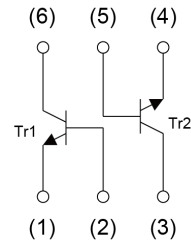

IMX1

- (1) Tr1 Collector
- (2) Tr2 Base
- (3) Tr2 Emitter
- (4) Tr2 Collector
- (5) Tr1 Base
- (6) Tr1 Emitter

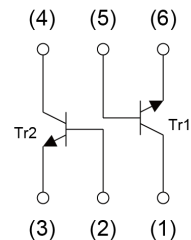

●Application

GENERAL PURPOSE SMALL SIGNAL AMPLIFIER

●Packaging specifications

| Part No. | Package | Package size | Taping code | Reel size (mm) | Tape width (mm) | Basic ordering unit.(pcs) | Marking |
|----------|-------------------|--------------|-------------|----------------|-----------------|---------------------------|---------|
| EMX1 | SOT-563 (EMT6) | 1616 | T2R | 180 | 8 | 8000 | X1 |
| UMX1N | SOT-363 (UMT6) | 2021 | TN | 180 | 8 | 3000 | X1 |
| IMX1 | SOT-457 (SMT6) | 2928 | T110 | 180 | 8 | 3000 | X1 |

● **Absolute maximum ratings** ($T_a = 25^\circ\text{C}$)

<For Tr1 and Tr2 in common>

| Parameter | | Symbol | Values | Unit |
|------------------------------|-------------|--------------|-------------|------------------|
| Collector-base voltage | | V_{CBO} | 60 | V |
| Collector-emitter voltage | | V_{CEO} | 50 | V |
| Emitter-base voltage | | V_{EBO} | 7 | V |
| Collector current | | I_C | 150 | mA |
| Power dissipation | EMX1/ UMX1N | P_D^{*1*2} | 150 | mW/Total |
| | IMX1 | P_D^{*1*3} | 300 | mW/Total |
| Junction temperature | | T_j | 150 | $^\circ\text{C}$ |
| Range of storage temperature | | T_{stg} | -55 to +150 | $^\circ\text{C}$ |

● **Electrical characteristics** ($T_a = 25^\circ\text{C}$)

<For Tr1 and Tr2 in common>

| Parameter | Symbol | Conditions | Values | | | Unit |
|--------------------------------------|---------------|---|--------|------|------|------|
| | | | Min. | Typ. | Max. | |
| Collector-base breakdown voltage | BV_{CBO} | $I_C = 50\mu\text{A}$ | 60 | - | - | V |
| Collector-emitter breakdown voltage | BV_{CEO} | $I_C = 1\text{mA}$ | 50 | - | - | V |
| Emitter-base breakdown voltage | BV_{EBO} | $I_E = 50\mu\text{A}$ | 7 | - | - | V |
| Collector cut-off current | I_{CBO} | $V_{CB} = 60\text{V}$ | - | - | 100 | nA |
| Emitter cut-off current | I_{EBO} | $V_{EB} = 7\text{V}$ | - | - | 100 | nA |
| Collector-emitter saturation voltage | $V_{CE(sat)}$ | $I_C = 50\text{mA}, I_B = 5\text{mA}$ | - | - | 400 | mV |
| DC current gain | h_{FE} | $V_{CE} = 6\text{V}, I_C = 1\text{mA}$ | 120 | - | 560 | - |
| Transition frequency | f_T | $V_{CE} = 12\text{V}, I_E = -2\text{mA}, f = 100\text{MHz}$ | - | 180 | - | MHz |
| Output capacitance | C_{ob} | $V_{CB} = 12\text{V}, I_E = 0\text{A}, f = 1\text{MHz}$ | - | 2.0 | 3.5 | pF |

*1 Each terminal mounted on a reference land.

*2 120mW per element must not be exceeded.

*3 200mW per element must not be exceeded.

● Electrical characteristic curves ($T_a = 25^\circ\text{C}$)

<For Tr1 and Tr2 in common>

Fig.1 Ground Emitter Propagation Characteristics

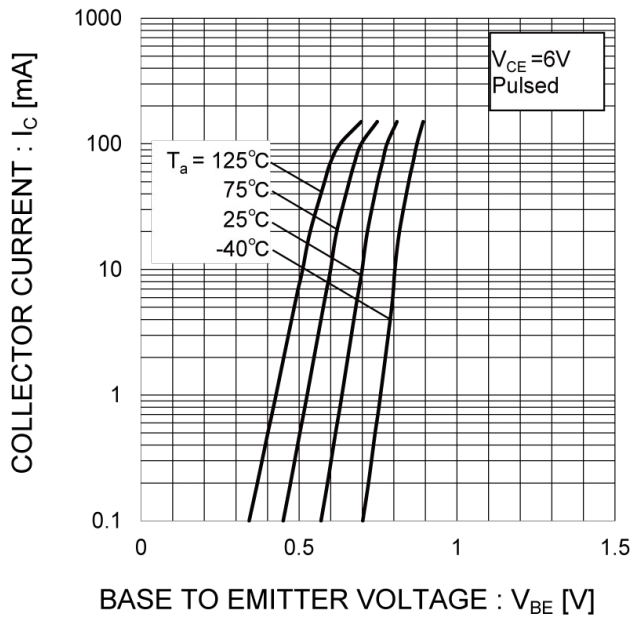

Fig.2 Grounded Emitter Output Characteristics

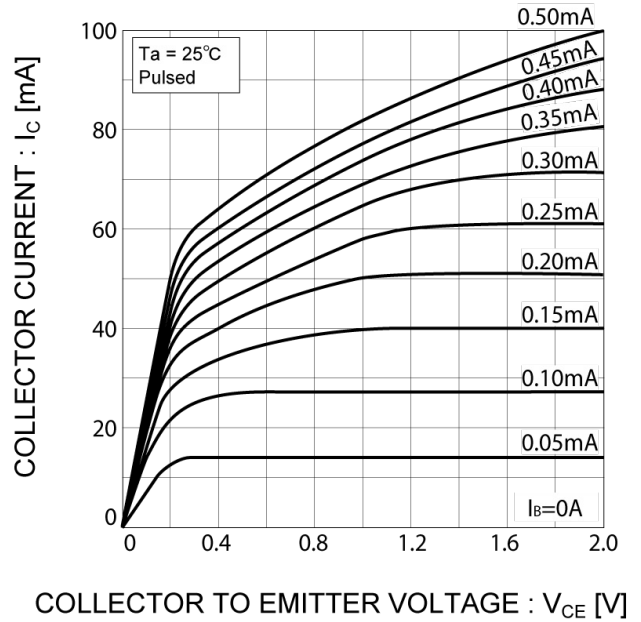

Fig.3 DC Current Gain vs. Collector Current (I)

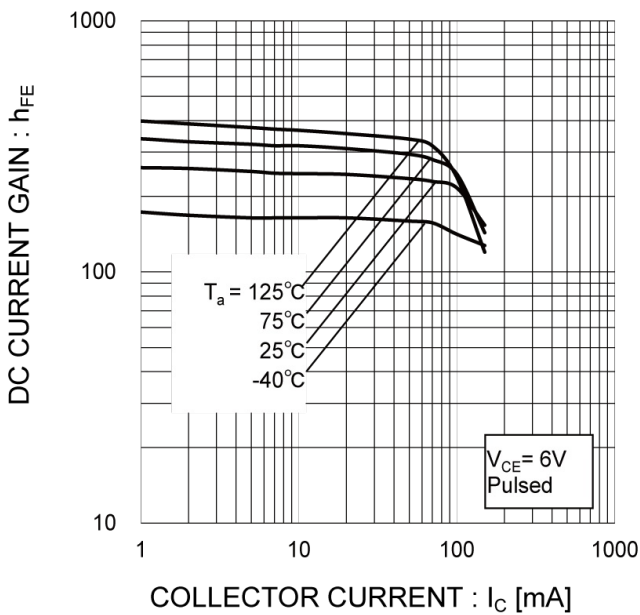
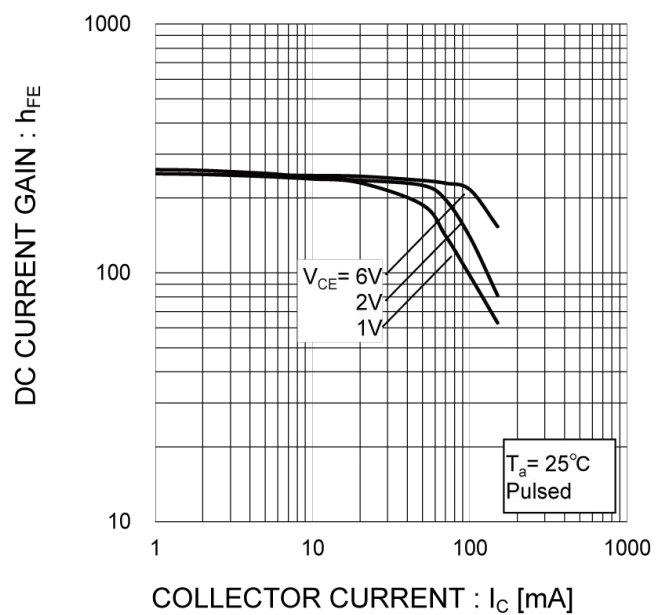

Fig.4 DC Current Gain vs. Collector Current (II)



● Electrical characteristic curves ($T_a = 25^\circ\text{C}$)

<For Tr1 and Tr2 in common>

Fig.5 Collector-Emitter Saturation Voltage vs. Collector Current(I)

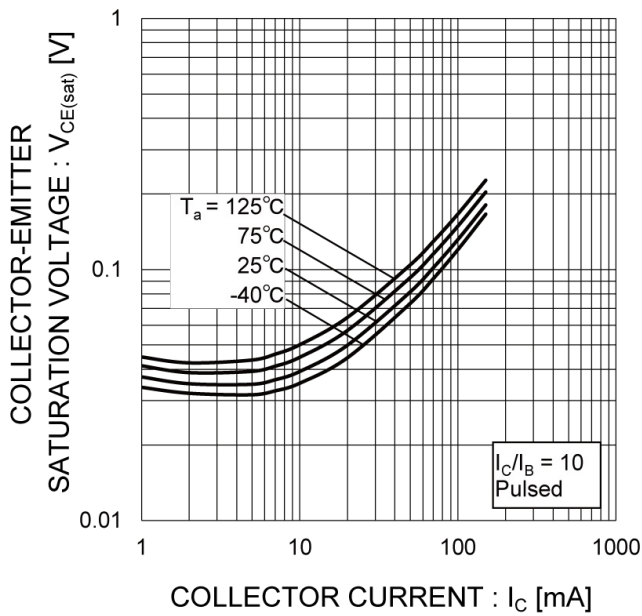

Fig.6 Collector-Emitter Saturation Voltage vs. Collector Current(II)

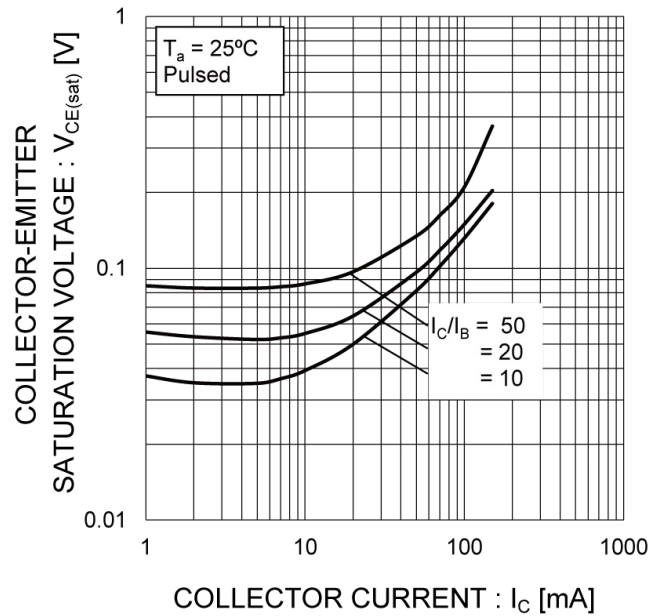

Fig.7 Base-Emitter Saturation Voltage vs. Collector Current (I)

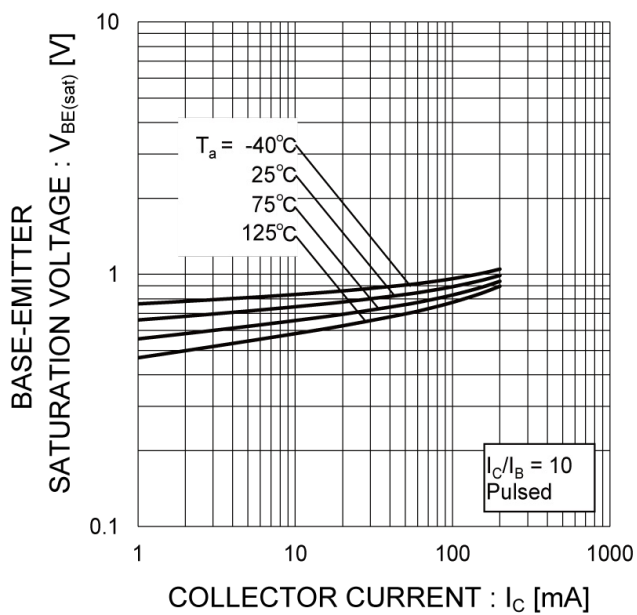
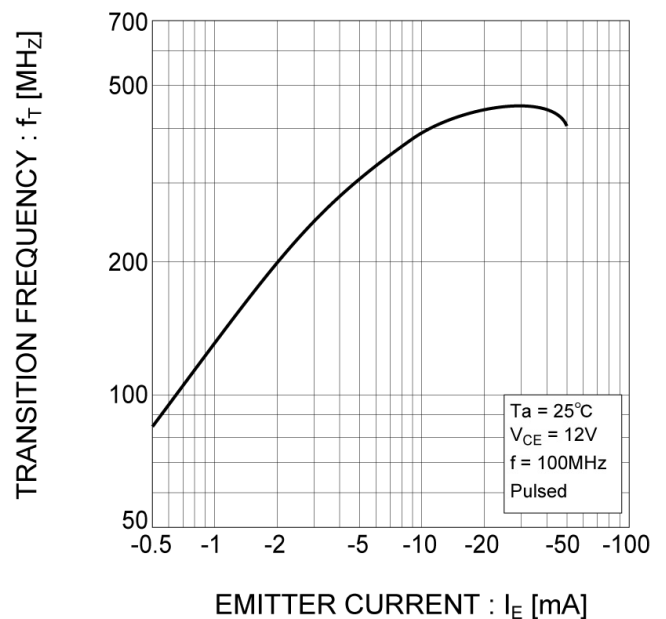

Fig.8 Gain Bandwidth Product vs. Emitter Current



● Electrical characteristic curves ($T_a = 25^\circ\text{C}$)

<For Tr1 and Tr2 in common>

Fig.9 Collector Output Capacitance vs. Collector-Base Voltage
Emitter Input Capacitance vs. Emitter-Base Voltage

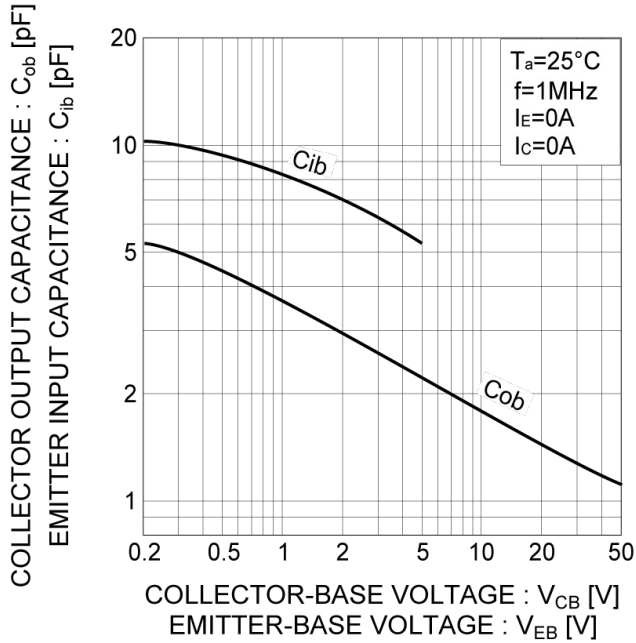

Fig.10 Safe Operating Area

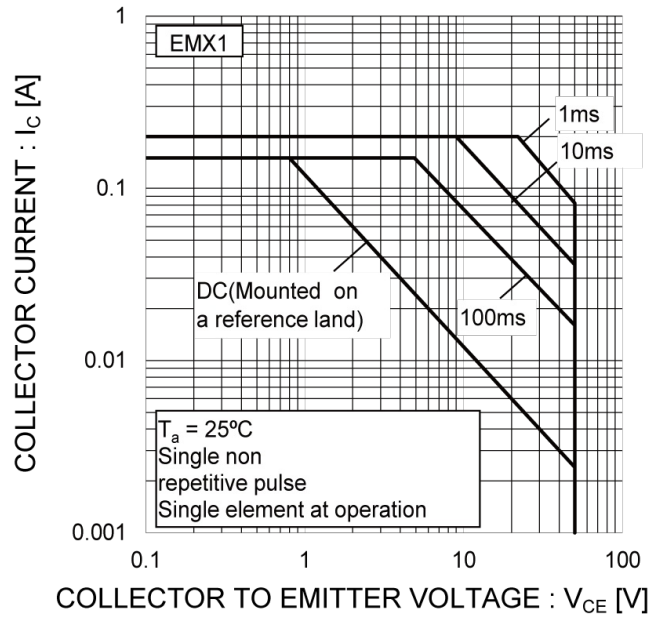

Fig.11 Safe Operating Area

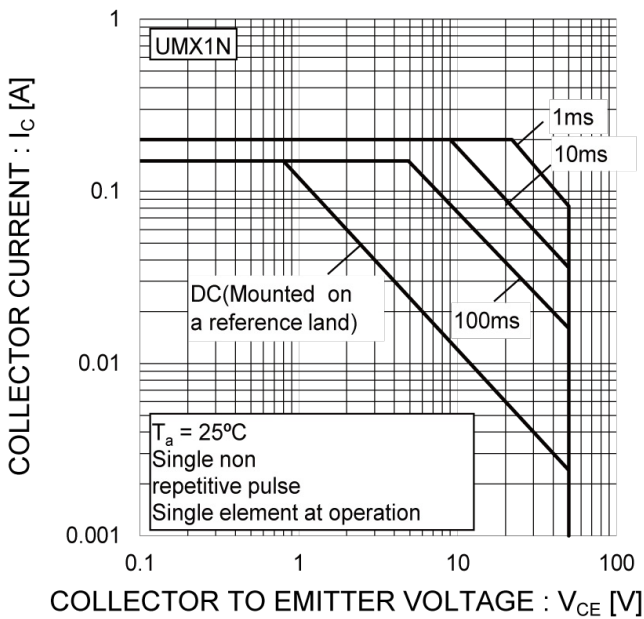
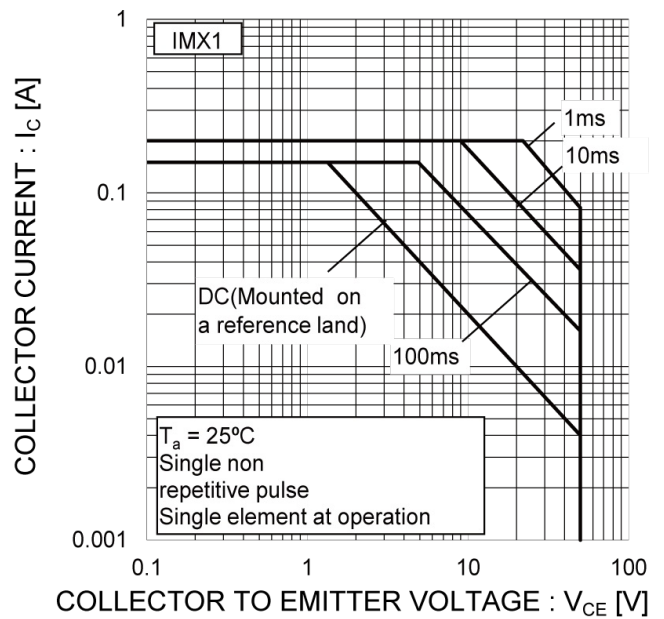
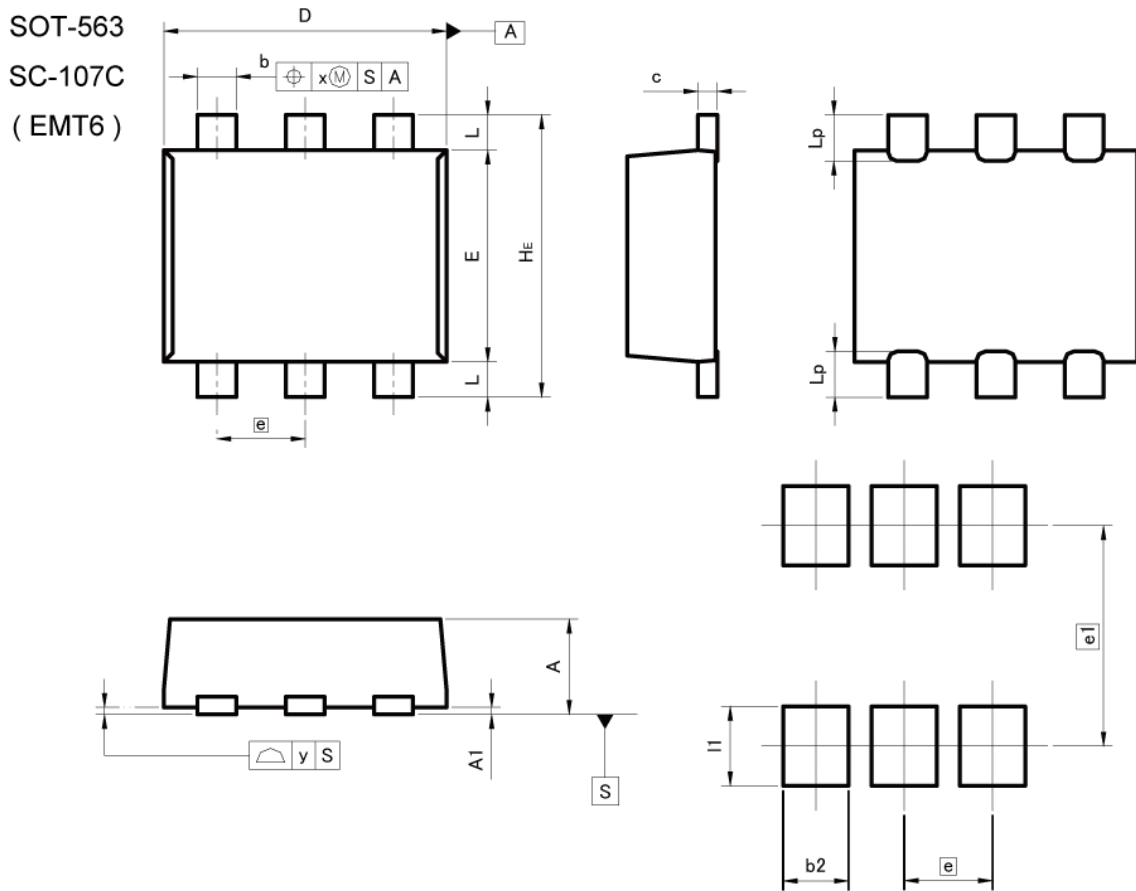

Fig.12 Safe Operating Area



●Dimensions



Pattern of terminal position areas
[Not a pattern of soldering pads]

| DIM | MILIMETERS | | INCHES | |
|-----|------------|------|--------|-------|
| | MIN | MAX | MIN | MAX |
| A | 0.45 | 0.55 | 0.018 | 0.022 |
| A1 | 0.00 | 0.10 | 0.000 | 0.004 |
| b | 0.17 | 0.27 | 0.007 | 0.011 |
| c | 0.08 | 0.18 | 0.003 | 0.007 |
| D | 1.50 | 1.70 | 0.059 | 0.067 |
| E | 1.10 | 1.30 | 0.043 | 0.051 |
| e | 0.50 | | 0.020 | |
| HE | 1.50 | 1.70 | 0.059 | 0.067 |
| L | 0.10 | 0.30 | 0.004 | 0.012 |
| Lp | - | 0.35 | - | 0.014 |
| x | - | 0.10 | - | 0.004 |
| y | - | 0.10 | - | 0.004 |

| DIM | MILIMETERS | | INCHES | |
|-----|------------|------|--------|-------|
| | MIN | MAX | MIN | MAX |
| b2 | - | 0.37 | - | 0.015 |
| e1 | 1.25 | | 0.049 | |
| I1 | - | 0.45 | - | 0.018 |

Dimension in mm/inches

●Dimensions

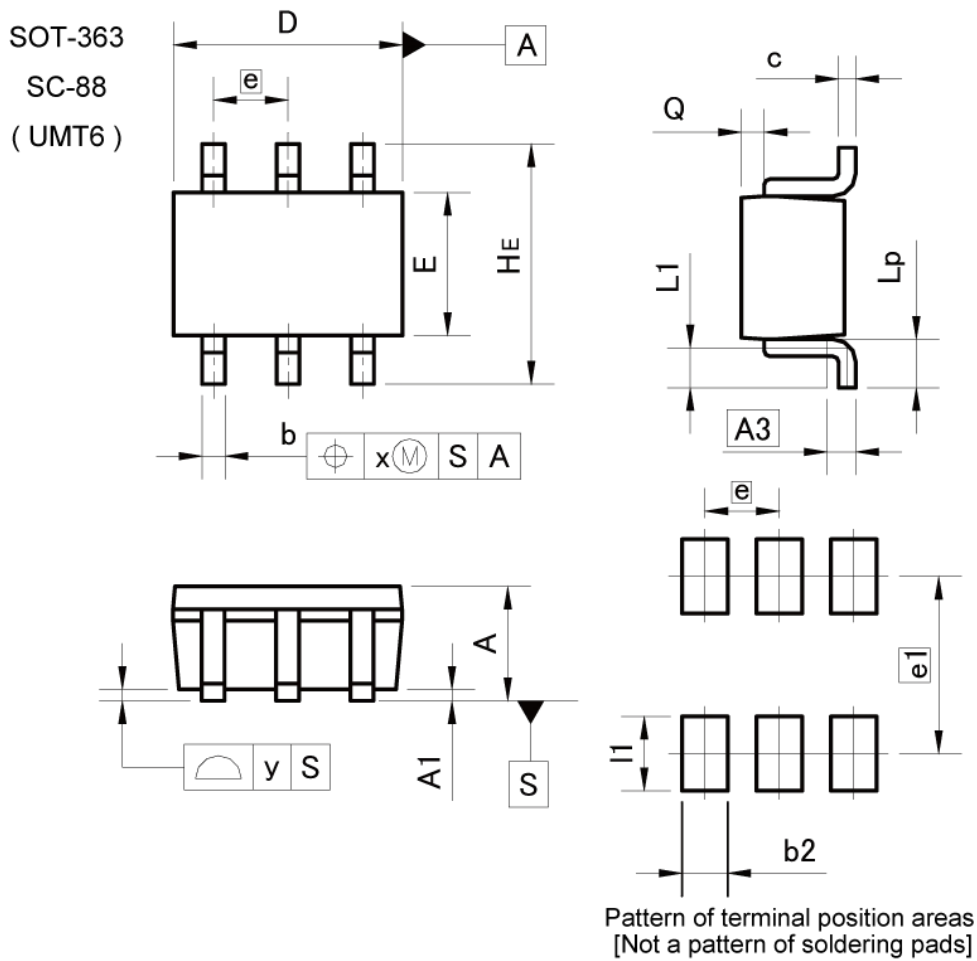

| DIM | MILIMETERS | | INCHES | |
|-----|------------|------|--------|-------|
| | MIN | MAX | MIN | MAX |
| A | 0.80 | 1.00 | 0.031 | 0.039 |
| A1 | 0.00 | 0.10 | 0.000 | 0.004 |
| A3 | 0.25 | | 0.010 | |
| b | 0.15 | 0.30 | 0.006 | 0.012 |
| c | 0.10 | 0.20 | 0.004 | 0.008 |
| D | 1.90 | 2.10 | 0.075 | 0.083 |
| E | 1.15 | 1.35 | 0.045 | 0.053 |
| e | 0.65 | | 0.026 | |
| HE | 2.00 | 2.20 | 0.079 | 0.087 |
| L1 | 0.20 | 0.50 | 0.008 | 0.020 |
| Lp | 0.25 | 0.55 | 0.010 | 0.022 |
| Q | 0.10 | 0.30 | 0.004 | 0.012 |
| x | - | 0.10 | - | 0.004 |
| y | - | 0.10 | - | 0.004 |

| DIM | MILIMETERS | | INCHES | |
|-----|------------|------|--------|-------|
| | MIN | MAX | MIN | MAX |
| b2 | - | 0.40 | - | 0.016 |
| e1 | 1.55 | | 0.061 | |
| I1 | - | 0.65 | - | 0.026 |

Dimension in mm/inches

●Dimensions

SOT-457
SC-74
(SMT6)

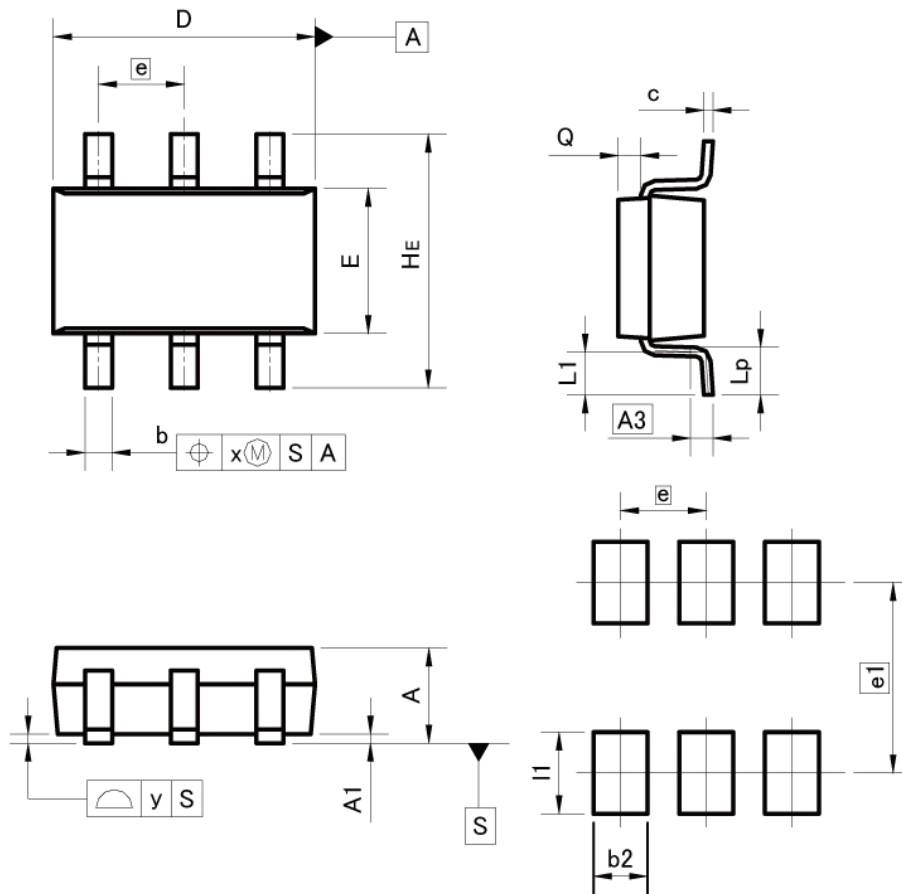

Pattern of terminal position areas
[Not a pattern of soldering pads]

| DIM | MILIMETERS | | INCHES | |
|-----|------------|------|--------|-------|
| | MIN | MAX | MIN | MAX |
| A | 1.00 | 1.30 | 0.039 | 0.051 |
| A1 | 0.00 | 0.10 | 0.000 | 0.004 |
| A3 | 0.25 | | 0.010 | |
| b | 0.25 | 0.40 | 0.010 | 0.016 |
| c | 0.09 | 0.25 | 0.004 | 0.010 |
| D | 2.80 | 3.00 | 0.110 | 0.118 |
| E | 1.50 | 1.80 | 0.059 | 0.071 |
| e | 0.95 | | 0.037 | |
| HE | 2.60 | 3.00 | 0.102 | 0.118 |
| L1 | 0.30 | 0.60 | 0.012 | 0.024 |
| Lp | 0.40 | 0.70 | 0.016 | 0.028 |
| Q | 0.20 | 0.30 | 0.008 | 0.012 |
| x | - | 0.20 | - | 0.008 |
| y | - | 0.10 | - | 0.004 |

| DIM | MILIMETERS | | INCHES | |
|-----|------------|------|--------|-------|
| | MIN | MAX | MIN | MAX |
| b2 | - | 0.60 | - | 0.024 |
| e1 | 2.10 | | 0.083 | |
| I1 | - | 0.90 | - | 0.035 |

Dimension in mm/inches

Notes

- 1) The information contained herein is subject to change without notice.
- 2) Before you use our Products, please contact our sales representative and verify the latest specifications :
- 3) Although ROHM is continuously working to improve product reliability and quality, semiconductors can break down and malfunction due to various factors. Therefore, in order to prevent personal injury or fire arising from failure, please take safety measures such as complying with the derating characteristics, implementing redundant and fire prevention designs, and utilizing backups and fail-safe procedures. ROHM shall have no responsibility for any damages arising out of the use of our Products beyond the rating specified by ROHM.
- 4) Examples of application circuits, circuit constants and any other information contained herein are provided only to illustrate the standard usage and operations of the Products. The peripheral conditions must be taken into account when designing circuits for mass production.
- 5) The technical information specified herein is intended only to show the typical functions of and examples of application circuits for the Products. ROHM does not grant you, explicitly or implicitly, any license to use or exercise intellectual property or other rights held by ROHM or any other parties. ROHM shall have no responsibility whatsoever for any dispute arising out of the use of such technical information.
- 6) The Products are intended for use in general electronic equipment (i.e. AV/OA devices, communication, consumer systems, gaming/entertainment sets) as well as the applications indicated in this document.
- 7) The Products specified in this document are not designed to be radiation tolerant.
- 8) For use of our Products in applications requiring a high degree of reliability (as exemplified below), please contact and consult with a ROHM representative : transportation equipment (i.e. cars, ships, trains), primary communication equipment, traffic lights, fire/crime prevention, safety equipment, medical systems, servers, solar cells, and power transmission systems.
- 9) Do not use our Products in applications requiring extremely high reliability, such as aerospace equipment, nuclear power control systems, and submarine repeaters.
- 10) ROHM shall have no responsibility for any damages or injury arising from non-compliance with the recommended usage conditions and specifications contained herein.
- 11) ROHM has used reasonable care to ensure the accuracy of the information contained in this document. However, ROHM does not warrant that such information is error-free, and ROHM shall have no responsibility for any damages arising from any inaccuracy or misprint of such information.
- 12) Please use the Products in accordance with any applicable environmental laws and regulations, such as the RoHS Directive. For more details, including RoHS compatibility, please contact a ROHM sales office. ROHM shall have no responsibility for any damages or losses resulting non-compliance with any applicable laws or regulations.
- 13) When providing our Products and technologies contained in this document to other countries, you must abide by the procedures and provisions stipulated in all applicable export laws and regulations, including without limitation the US Export Administration Regulations and the Foreign Exchange and Foreign Trade Act.
- 14) This document, in part or in whole, may not be reprinted or reproduced without prior consent of ROHM.



Thank you for your accessing to ROHM product informations.
More detail product informations and catalogs are available, please contact us.

ROHM Customer Support System

<http://www.rohm.com/contact/>



UMX1N - Web Page

[Distribution Inventory](#)

| | |
|-----------------------------|---------|
| Part Number | UMX1N |
| Package | UMT6 |
| Unit Quantity | 3000 |
| Minimum Package Quantity | 3000 |
| Packing Type | Taping |
| Constitution Materials List | inquiry |
| RoHS | Yes |