

Audio Transformers:

2 Ohm to 30K Ohm; 400Hz to 250KHz; 100 milliwatt at 1KHz

SURFACE MOUNT

PICO surface mount units utilize materials and methods to withstand extreme temperatures (220° C) of vapor phase, I.R., and other reflow procedures without degradation of electrical or mechanical characteristics.

Specifications

- **MIL-PRF-27:** All units manufactured to MIL-PRF-27, Grade 5, Class S
- **FREQUENCY RESPONSE:** ± 3db, 400 Hz-250 KHz at 1.0 Milliwatt.
- **MAXIMUM DISTORTION:** 5% with rated power level at 1 KHz and 400 Hz.
- **DIELECTRIC STRENGTH:** All units tested at 200 V RMS.
- **INSULATION RESISTANCE:** Greater than 10,000 Megohms at 300 V DC.
- **WEIGHT:** 1.5 Grams
- **TERMINALS:** Solderability per MIL-STD-202, Method 208.
- **THERMAL SHOCK:** 25 Cycles, Method 107, MIL-STD-202, Test Condition -55° C to +130° C.
- **MOISTURE SENSITIVITY LEVEL :** MSL3

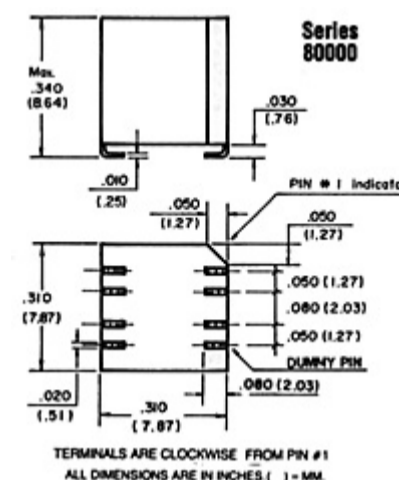
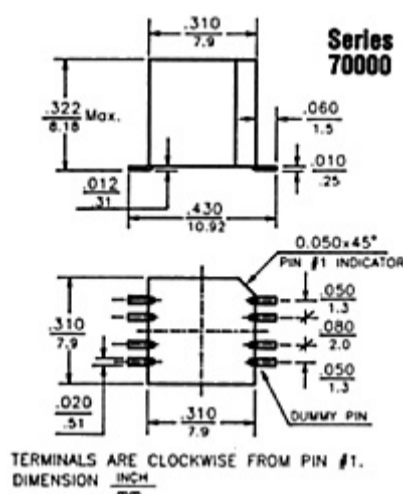

Audio Transformers: 2 Ohm to 30K Ohm; 400Hz to 250KHz; 100 milliwatt at 1KHz

Gull Wing PICO Part Number	J Lead PICO Part Number	Prim Imped Ohms	Secondary Impedance Ohms Split Windings		Power Milliwatts		Primary Unbal DC Current ma	Prim DC Resist Ohms	Secondary DC Resistance Ohms		Turns/Ratio Prim/Sec		Pico Prices 1-9 *** (US \$)
			SER	PAR	1KHz and higher	400Hz and higher			SER CONN	PAR CONN	SEC SER CONN	SEC PAR CONN	
70003	80003	10ct	10ct	2.5	125	20	11.5	1.1	1.35	.34	1:1	2:1	73.75
70005	80005	20ct	8ct	2	125	20	8	2.1	1.28	.32	1.58:1	3.16:1	73.75
70010	80010	20ct	20ct	5	125	20	8	2.1	2.56	.64	1:1	2:1	73.75
70015	80015	32ct	32ct	8	125	20	6.5	3.52	4.32	1.08	1:1	2:1	73.75
70020	80020	40ct	40ct	10	125	20	5.6	4	4.77	1.19	1:1	2:1	73.17
70025	80025	48ct	16ct	4	125	20	5.2	4.3	2.3	.58	1.73:1	3.46:1	67.04
70030	80030	50ct	50ct	12.5	125	20	5	5.5	6.6	1.65	1.1	2:1	67.04
70035	80035	80ct	32ct	8	125	20	4	8.5	4.25	1.06	1.58:1	3.16:1	73.17
70040	80040	100ct	40ct	10	125	20	3.6	12.1	4.85	1.21	1.58:1	3.16:1	73.17
70045	80045	100ct	100ct	25	125	20	3.6	12.1	12	3	1:1	2:1	67.04

70050	80050	120ct	12.8ct	3.2	125	20	3.3	13.2	1.6	.4	3.06:1	6.12:1	67.04
70055	80055	120ct	60ct	15	125	20	3.3	13.2	7.3	1.83	1.41:1	2.83:1	80.18
70060	80060	120ct	120ct	30	125	20	3.3	13.2	16	4	1:1	2:1	80.18
70065	80065	150ct	12ct	3	125	20	3	15	1.56	.39	3.54:1	7.07:1	77.63
70070	80070	150ct	50ct	12.5	125	20	3	15	6.6	1.65	1.73:1	3.46:1	80.18
70075	80075	150ct	100ct	25	125	20	3	15	14.5	3.63	1.22:1	2.45:1	80.18
70080	80080	150ct	150ct	37.5	125	20	3	15	18.3	4.58	1:1	2:1	80.18
70085	80085	150ct	600ct	150	125	20	3	15	72	18	1:2	1:1	80.18
70090	80090	200ct	200ct	50	125	20	2.5	22	25.8	6.7	1:1	2:1	80.18
70095	80095	300ct	12ct	3	125	20	2	33	1.56	.39	5:1	10:1	80.18
70100	80100	300ct	50ct	12.5	125	20	2	33	6.6	1.65	2.45:1	4.9:1	80.18
70105	80105	300ct	150ct	37.5	125	20	2	33	18.3	4.58	1:1.41	2.83:1	80.18
70110	80110	300ct	300ct	75	125	20	2	33	40.3	10.08	1:1	2:1	80.18
70115	80115	300ct	600ct	150	125	20	2	33	72	18	1:1.41	1.41:1	72.88
70120	80120	320ct	12.8ct	3.2	125	20	2	34	1.6	.4	5:1	10:1	85.97
70125	80125	400ct	40ct	10	125	20	1.8	49	4.7	1.18	3.16:1	6.32:1	85.97
70130	80130	400ct	120ct	30	125	20	1.8	49	16.3	4.08	1.83:1	3.65:1	85.97
70135	80135	400ct	200ct	50	125	20	1.8	49	27.3	6.83	1.41:1	2.83:1	85.97
70140	80140	400ct	400ct	100	125	20	1.8	49	49	12.25	1:1	2:1	78.18
70145	80145	400ct	1000ct	250	125	20	1.8	48	120	30	1:1.58	1.26:1	85.97
70150	80150	400ct	2000ct	500	125	20	1.8	49	270	67.5	1:2.24	1:1.12	85.97
70155	80155	400ct	4000ct	1000	125	20	1.8	49	476	119	1:3.16	1:1.58	85.97
70160	80160	500ct	12.8ct	3.2	125	20	1.6	54	1.6	0.4	6.25:1	12.5:1	78.18
70165	80165	500ct	16ct	4	125	20	1.6	54	2.3	0.58	5.6:1	11.2:1	78.18
70170	80170	500ct	50ct	12.5	125	20	1.6	54	6.6	1.65	3.16:1	6.32:1	78.18
70175	80175	500ct	150ct	37.5	125	20	1.6	54	18.3	4.58	1.83:1	3.65:1	78.18
70180	80180	500ct	500ct	125	125	20	1.6	54	65	16.3	1:1	2:1	85.97
70185	80185	*500ct	500ct	-	125	20	1.6	54	65	-	1:1	-	85.97
70190	80190	500ct	600ct	150	125	20	1.6	54	72	18	1:1.1	1.83:1	85.97
70195	80195	600ct	12.8ct	3.2	125	20	1.5	59	1.6	0.4	6.85:1	13.7:1	85.97
70200	80200	600ct	30ct	7.5	125	20	1.5	59	4.1	1.03	4.47:1	8.94:1	78.18
70205	80205	600ct	48ct	12	125	20	1.5	59	5.2	1.3	3.54:1	7.07:1	78.18
70210	80210	600ct	200ct	50	125	20	1.5	59	26.5	6.63	1.73:1	3.46:1	78.18
70215	80215	600ct	600ct	150	125	20	1.5	59	72	18	1:1	2:1	78.18
70220	80220	*600ct	600ct	-	125	20	1.5	59	72	-	1:1	-	85.97
70225	80225	600ct	1200ct	300	125	20	1.5	59	160	40	1:1.41	1.41:1	78.18
70230	80230	640ct	12.8ct	3.2	125	20	1.5	62	1.6	0.4	7.07:1	14.14:1	78.18
70235	80235	700ct	100ct	25	125	20	1.35	65	12	3	2.65:1	5.29:1	78.18
70240	80240	800ct	12.8ct	3.2	125	20	1.3	88	15	4	7.9:1	15.8:1	85.97
70245	80245	800ct	48ct	12	125	20	1.3	88	6.7	1.68	4.08:1	8.16:1	80.18
70250	80250	800ct	800ct	200	125	20	1.3	88	106	26.5	1:1	2:1	80.18
70255	80255	900ct	600ct	150	125	20	1.2	93	74	18.5	1.22:1	2.45:1	80.18
70260	80260	1000ct	12ct	3	125	20	1.2	120	1.55	0.39	9.13:1	18.3:1	88.24
70265	80265	1000ct	50ct	12.5	125	20	1.2	120	6.6	1.65	4.47:1	8.94:1	88.24
70270	80270	1000ct	1000ct	250	125	20	1.2	120	120	30	1:1	2:1	80.18
70275	80275	1060ct	12.8ct	3.2	125	20	1.2	125	1.6	0.4	9.1:1	18.2:1	88.24
70280	80280	1200ct	12.8ct	3.2	125	20	1	133	1.6	0.4	9.68:1	19.4:1	88.24
70285	80285	1200ct	500ct	125	125	20	1	133	65	16.25	1.55:1	3.1:1	88.24
70290	80290	1200ct	1200ct	300	125	20	1	133	160	40	1:1	2:1	88.24
70295	80295	*1200ct	1200ct	-	125	20	1	133	160	-	1:1	-	88.24
Gull Wing PICO Part Number	J Lead PICO Part Number	Prim Imped Ohms	Secondary Impedence Ohms Split Windings		Power Milliwatts		Primary Unbal DC Current ma	Prim DC Resist Ohms	Secondary DC Resistance Ohms		Turns/Ratio Prim/Sec		Pico Prices 1-9 *** (US \$)
			SER	PAR	1KHz and higher	400Hz and higher			SER CONN	PAR CONN	SEC SER CONN	SEC PAR CONN	
70300	80300	1500ct	12ct	3	125	20	1	180	1.55	0.39	11.2:1	22.4:1	88.24
70305	80305	1500ct	500ct	125	125	20	1	180	65	16.3	1.73:1	3.46:1	80.18
70310	80310	*1500ct	600ct	-	125	20	1	180	73	-	1.58:1	-	80.18
70315	80315	*1500ct	1500ct	-	125	20	1	180	215	-	1:1	-	88.24
70320	80320	1600ct	12.8ct	3.2	125	20	1	190	1.6	0.4	11.2:1	22.4:1	88.24

70325	80325	2000ct	8ct	2	125	20	0.8	218	1	0.25	15.8:1	31.6:1	88.24
70330	80330	2000ct	2000ct	500	125	20	0.8	218	260	65	1:1	2.1:1	88.24
70335	80335	*2000ct	2000ct	-	125	20	0.8	218	260	-	1:1	-	88.24
70340	80340	2000ct	8000ct	2000	125	20	0.8	218	830	207.5	1:2	1:1	88.24
70345	80345	2500ct	2500ct	625	125	20	0.75	280	280	70	1:1	2:1	85.97
70350	80350	3000ct	3000ct	725	125	20	0.65	330	330	82.5	1:1	2:1	85.97
70355	80355	*3000ct	3000ct	-	125	20	0.65	330	330	-	1:1	-	85.97
70360	80360	3600ct	3600ct	900	125	20	0.6	370	450	112.5	1:1	2:1	85.97
70365	80365	4000ct	16ct	4	125	20	0.57	400	2.3	0.58	15.8:1	31.6:1	85.97
70370	80370	4000ct	600ct	150	125	20	0.57	400	73	18.25	2.58:1	5.16:1	85.97
70375	80375	4000ct	1000ct	250	125	20	0.57	400	120	30	2:1	4:1	85.97
70380	80380	*4000ct	8000ct	-	125	20	0.57	400	1070	-	1:1.41	-	94.52
70385	80385	5000ct	500ct	125	125	20	0.5	540	65	16.25	3.16:1	6.32:1	85.97
70390	80390	5000ct	5000ct	1250	125	20	0.5	540	650	162.5	1:1	2:1	85.97
70395	80395	7500ct	50ct	12.5	125	20	.5	835	6.6	1.65	12.2:1	24.5:1	94.52
70400	80400	7500ct	100ct	25	125	20	0.4	835	12	3	8.66:1	17.3:1	86.84
70405	80405	7500ct	600ct	150	125	20	0.4	835	72	18	3.54:1	7.07:1	86.84
70410	80410	7500ct	2500ct	625	125	20	0.4	835	280	70	1.73:1	3.46:1	86.84
70415	80415	*7500ct	7500ct	-	125	20	0.4	835	1020	-	1:1	-	86.84
70420	80420	8000ct	12.8ct	3.2	125	20	0.4	865	1.6	0.4	25:1	50:1	94.52
70425	80425	8000ct	1000ct	250	125	20	0.4	865	120	30	2.83:1	5.66:1	94.52
70430	80430	*8000ct	1200ct	-	125	20	0.4	865	160	-	2.58:1	-	94.52
70435	80435	*9000ct	9000ct	-	125	20	0.4	1160	1160	-	1:1	-	94.85
70440	80440	10,000ct	12.8ct	3.2	125	20	0.36	1200	1.6	0.4	28:1	56:1	94.85
70445	80445	10,000ct	16ct	4	125	20	0.36	1200	1.77	0.44	25:1	50:1	86.84
70450	80450	10,000ct	100ct	25	125	20	0.36	1200	12	3	10:1	20:1	86.84
70455	80455	10,000ct	200ct	50	125	20	0.36	1200	27	6.75	7.07:1	14.14:1	86.84
70460	80460	10,000ct	500ct	125	125	20	0.36	1200	65	16.25	4.47:1	8.94:1	86.84
70465	80465	10,000ct	600ct	150	125	20	0.36	1200	72	18	4.08:1	8.16:1	86.84
70470	80470	10,000ct	1000ct	250	125	20	0.36	1200	120	30	3.16:1	6.32:1	86.84
70475	80475	10,000ct	1200ct	300	125	20	0.36	1200	160	40	2.88:1	5.77:1	86.84
70480	80480	10,000ct	1500ct	375	125	20	0.36	1200	215	53.8	2.58:1	5.16:1	88.24
70485	80485	10,000ct	2000ct	500	125	20	0.36	1200	260	65	2.24:1	4.47:1	88.24
70490	80490	10,000ct	5000ct	1250	125	20	0.36	1200	650	162.5	1.41:1	2.83:1	88.24
70495	80495	10,000ct	7500ct	1875	125	20	0.36	1200	1020	255	1.15:1	2.3:1	88.24
70500	80500	10,000ct	10,000ct	2500	125	20	0.36	1200	1200	300	1:1	2:1	80.18
70505	80505	*10,000ct	10,000ct	-	125	20	0.36	1200	1440	-	1:1	-	94.52
70510	80510	15,000ct	400ct	100	100	15	0.35	1420	43	10.75	6.12:1	12.24:1	86.84
70515	80515	15,000ct	500ct	125	100	15	0.35	1420	49	12.25	5.48:1	10.95:1	86.84
70520	80520	15,000ct	600ct	150	100	15	0.35	1420	68	17	5:1	10:1	86.84
70525	80525	15,000ct	10,000ct	2500	100	15	0.35	1420	1100	275	1.22:1	2.45:1	86.84
70530	80530	*15,000ct	15,000ct	-	100	15	0.35	1420	1730	-	1:1	-	94.52
70535	80535	15,000ct	15,000ct	3750	100	15	0.35	1420	1730	433	1:1	2:1	88.24
70540	80540	16,000ct	1000ct	250	100	15	0.35	1500	115	28.75	4:1	8:1	88.24

Gull Wing PICO Part Number	J Lead PICO Part Number	Prim Imped Ohms	Secondary Impedance Ohms Split Windings		Power Milliwatts		Primary Unbal DC Current ma	Prim DC Resist Ohms	Secondary DC Resistance Ohms		Turns/Ratio Prim/Sec		Pico Prices 1-9 *** (US \$)
			SER	PAR	1KHz and higher	400Hz and higher			SER CONN	PAR CONN	SEC SER CONN	SEC PAR CONN	
70545	80545	20,000ct	500ct	125	100	15	0.3	1600	60	15	6.33:1	12.65:1	94.52
70550	80550	20,000ct	600ct	150	100	15	0.3	1600	66	16.5	5.77:1	11.55:1	94.52
70555	80555	20,000ct	800ct	200	100	15	0.3	1600	94	23.5	5:1	10:1	94.52
70560	80560	20,000ct	1000ct	250	100	15	0.3	1600	106	26.5	4.47:1	8.94:1	94.52
70565	80565	20,000ct	5000ct	1250	100	15	0.3	1600	600	150	2:1	4:1	94.52
70570	80570	20,000ct	10,000ct	2500	100	15	0.3	1600	1100	275	1.41:1	2.83:1	94.52

* Includes Electrostatic Shield

INDUCTORS

All Inductors have split windings and measurements are listed for both series and parallel connections. Two values of inductance, each at a particular value of D.C. current are listed for each inductor.

Part Number	Part Number	Inductance		DC CURRENT ma	DC Resistance OHMS	Prices 1-9*** (US \$)
70825	80825	Series	10.0 2.75	0 2	2250	76.31
		Parallel	2.5 .65	0 4	560	
70830	80830	Series	5.5 1.5	0 2	1000	76.31
		Parallel	1.3 .40	0 4	250	
70835	80835	Series	.85 .25	1 6	240	76.31
		Parallel	.21 .06	2 12	60	
70840	80840	Series	.6 .15	0 5	144	76.31
		Parallel	.15 .04	0 10	36	

**Discount Prices:

- 1-9 Net;
- 10-24 less 10%;
- 25-49 less 16%;
- 50-99 less 23%;
- 100-499 less 30%

Ordering Instructions:

- No minimum.
- Net 30 days F.O.B. Pelham, NY

Delivery--stock to one week for sample orders.

FEATURES

- Extreme resistance to thermal shock
- Ultra Miniature size
- PICO is approved QPL source (MIL-PRF-27)
- Magnetic shield designs available
- Electrostatic shielding can be added
- Variation of standards designs available
- Every unit in this catalog can be made with a 300 thermal cycle guarantee using PICO's special SR construction. Contact factory for details.

Schematics

Schematics for Transformers with Split Secondaries

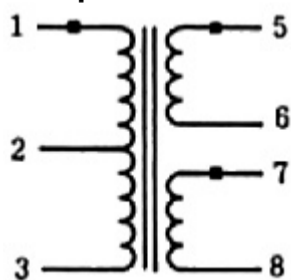

Schematics for Transformers with Electrostatic Shield

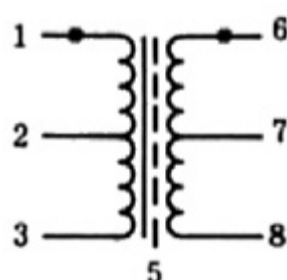

Schematics for Inductors

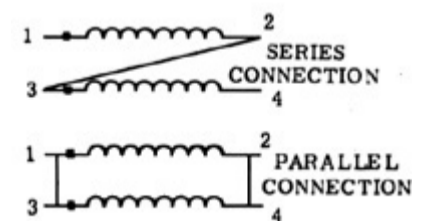

RECOMMENDED LAND PATTERN DIMENSIONS

PICO 70000 SERIES.

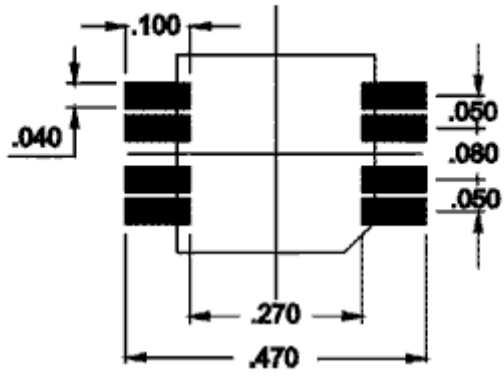

RECOMMENDED LAND PATTERN DIMENSIONS

PICO 80000 SERIES.

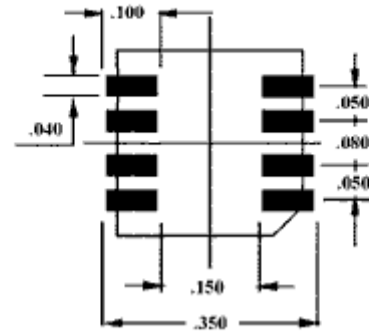

[Click Here For Thru Hole Version of the 70000 and 80000 Series](#) [3]

**For immediate engineering assistance or to place an order:
Call Toll Free: 800-431-1064**

PICO Electronics, Inc.

143 Sparks Ave. Pelham, NY 10803-1810
Tel: 914-738-1400 or Fax: 914-738-8225

[Go back to Surface Mount Transformers and Inductors Selections](#)[4]
