

## DAC1200, DAC1201 12-Bit Digital-to-Analog Converters

### General Description

The DAC1200 series of D/A converters is a family of precision low-cost converter building blocks intended to fulfill a wide range of industrial and military D/A applications. These devices are complete functional blocks requiring only application of power for operation. The design combines a precision 12-bit weighted current source (12 current switches and 12-bit thin-film resistor network), a rapid-settling operational amplifier, and 10.24V buffered reference.

Input coding is complementary binary. In all instances, a logic "low" ( $\leq 0.8V$ ) turns a given bit ON, and a logic "high" ( $\geq 2.0V$ ) turns the bit OFF. Output format may be programmed for bipolar ( $\pm 10V$ ) or unipolar (0 to 10V) operation using internally supplied thin-film resistor pin strap options. Current mode operation is also available from 0 to 2 mA.

The entire series is available in hermetically sealed 24-lead DIP.

### Features

- Circuit completely self-contained
- Both current and voltage-mode outputs
- Standard power supplies:  $\pm 15V$  and  $+5V$
- Internal buffered reference: 10.24V
- 0 to 2 mA,  $\pm 10V$  or 0 to 10V output by strapping internal resistors; other scales by external resistors
- $\pm 1/2$  LSB linearity
- Fast settling time: 1.5  $\mu s$  in current mode  
2.5  $\mu s$  in voltage mode
- High slew rate: 15 V/ $\mu s$
- TTL and CMOS compatible complementary binary input logic
- 12 bit linearity
- Standard 0.6" 24-pin DIP package

### Block and Connection Diagrams

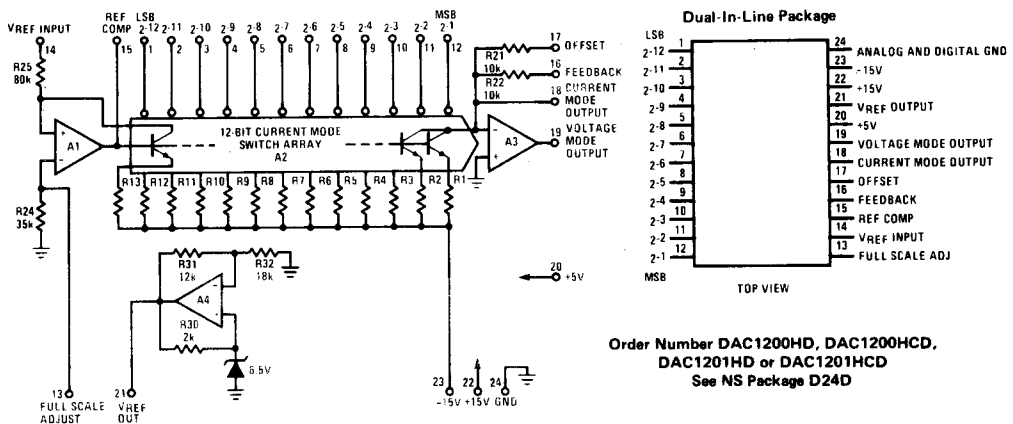

## Absolute Maximum Ratings

Supply Voltage ( $V^+$ & $V^-$ )	$\pm 18V$	Short Circuit Duration (pins 18, 19 & 21)	Continuous
Logic Supply Voltage ( $V_{CC}$ )	+10V	Operating Temperature Range	
Logic Input Voltage	-0.7V to +18V	DAC1200HD, DAC1201HD	-55°C to +125°C
Reference Input Voltage	-0V, +18V	DAC1200HCD, DAC1201HCD	-25°C to +85°C
Power Dissipation	(see graphs)	Storage Temperature Range	-65°C to +150°C
		Lead Temperature (soldering, 10 sec.)	300°C

## DC Electrical Characteristics DAC1200,1201 Binary D/A (Notes 1, 2)

PARAMETER	CONDITIONS	DAC1200/1200C			DAC1201/1201C			UNITS
		MIN	TYP	MAX	MIN	TYP	MAX	
Resolution		12			12			Bits
Linearity Error (Note 3)	$T_A = 25^\circ C$			+0.0122 $\pm 0.0244$			$\pm 0.0488$ $\pm 0.0976$	% FS % FS
Offset Voltage	$T_A = 25^\circ C$		1	5 10		1 10		mV mV
Voltage Mode Full-Scale Error (Note 3)	$V_{REF} = 10.240V$		0.01	0.1		0.02	0.2	% FS
Voltage Mode Full-Scale Error	Pin 21 connected to Pin 14, $T_A = 25^\circ C$		0.1	0.6		0.1	0.7	% FS
Monotonicity (Notes 3, 4)		Guaranteed over the temperature range						
Voltage Mode Power Supply Sensitivity	$\Delta V^+ = \pm 2V$ $\Delta V^- = \pm 2V$ $\Delta V_{CC} = \pm 1V$ $T_A = 25^\circ C$ $V_{REF} = 10.240V$		0.002	0.02		0.002	0.02	% FS/V % FS/V % FS/V
Output Voltage Range	$R_L = 5k$	$\pm 10.5$	$\pm 12$		$\pm 10.5$	$\pm 12$		V
Voltage Mode Output Short Circuit Current Limit	$T_A = 25^\circ C$		20	50		20	50	mA
Current Mode Voltage Compliance	(Note 5)	$\pm 2.5$			$\pm 2.5$			V
Current Mode Output Impedance			15			15		k $\Omega$
Reference Voltage	$0mA \leq I_{REF} \leq 2mA$ , $T_A = 25^\circ C$	10.190	10.240	10.290	10.190	10.240	10.290	V
Logic "1" Input Voltage (Bit OFF)		2.0			2.0			V
Logic "0" Input Voltage (Bit ON)				0.8			0.8	V
Logic "1" Input Current (Bit OFF)	$V_{IN} = 2.5V$		1	10		1	10	$\mu A$
Logic "0" Input Current (Bit ON)	$V_{IN} = 0V$		-10	-100		-10	-100	$\mu A$
Power Supply Current	$I^+$ $V^+ = 15.0V$ $I^-$ $V^- = -15.0V$ $I_{CC}$ $V_{CC} = 5.0V$ $T_A = 25^\circ C$		25	30		25	30	mA mA mA

## AC Electrical Characteristics DAC1200,1201

PARAMETER	CONDITIONS ( $T_A = 25^\circ C$ )	MIN	TYP	MAX	UNITS
Voltage Mode	DAC1200, $V_e \leq 1.25 mV$		1.5	3.0	$\mu s$
$\pm 1$ LSB Settling Time (Note 5)	DAC1201, $V_e \leq 5.0 mV$		1	3.0	$\mu s$
Voltage Mode Full-Scale Change Settling Time (Note 5)	DAC1200, $V_e \leq 1.25 mV$ DAC1201, $V_e \leq 5.0 mV$		2.5 2.0	5.0 5.0	$\mu s$ $\mu s$
Current Mode Full-Scale Settling Time	$R_L = 1k\Omega$ , $C_L \leq 20pF$ $0 \leq \Delta I_{OUT} \leq 2mA$		1.5		$\mu s$
Voltage Mode Slew Rate	$-10V \leq \Delta V_{OUT} \leq +10V$		15		V/ $\mu s$

**Note 1:** Unless otherwise noted, these specifications apply for  $V^+ = 15.0V$ ,  $V^- = -15.0V$ , and  $V_{CC} = 5.0V$  over the temperature range  $-55^\circ C$  to  $+125^\circ C$  for the DAC1200HD/1201HD and  $-25^\circ C$  to  $+85^\circ C$  for the DAC1200HCD/1201HCD.

**Note 2:** All typical values are for  $T_A = 25^\circ C$ .

**Note 3:** Unless otherwise noted, this specification applies for  $V_{REF} = 10.24V$ , and over the temperature range  $-25^\circ C$  to  $+85^\circ C$ . Testing conditions include adjustment of offset to 0V and full-scale to 10.2375V.

**Note 4:** The DAC1200 is tested for monotonicity by stimulating all bits; the DAC1201 is tested for monotonicity by stimulating only the 10 MSBs and holding the 2 LSBs at 2.0V (i.e., 2 LSBs are OFF).

**Note 5:** Not tested -- guaranteed by design.

## Typical Performance Characteristics

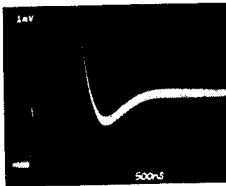
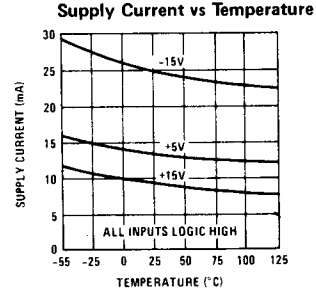
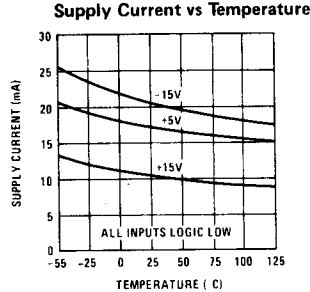
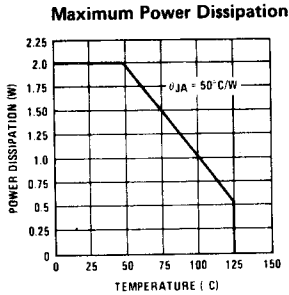

1 LSB Transition  
1011 ... 1 → 1100 ... 0  
V<sub>O</sub> = 0, 10V  
C<sub>F</sub> = 30pF  
T<sub>A</sub> = 25°C

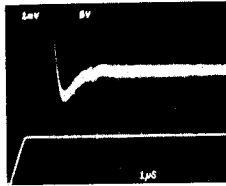

10V Full Scale Setting Time

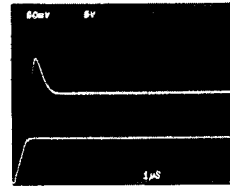

10V Full Scale Pulse Response

## Applications Information

### 1. Introduction

The DAC1200 series D/A converters are designed to minimize adjustments and user-supplied external components. For example, included in the package are a buffered reference, offset nulled output amplifier, and application resistors as well as the basic 12-bit current mode D/A.

However, the DAC1200 series is a sophisticated building block. Its principles of operation and the following applications information should be read before applying power to the device.

The user is referred to National Semiconductor Application Notes AN-156 and AN-157 for additional information.

### 2. Power Supply Selection & Decoupling

Selection of power supplies is important in applications requiring 0.01% accuracy. The ±15V supplies should be well regulated (±15V ± 0.1%) with less than 0.5mV<sub>rms</sub> of output noise and hum.

To realize the full speed capability of the device, all three power supply leads should be bypassed with 1µF tantalum electrolytic capacitors in shunt with 0.01µF ceramic disc capacitors no farther than ½ inch from the device package.

### 3. Unipolar and Bipolar Operation

The DAC1200 series D/A's may be configured for either unipolar or bipolar operation using resistors provided with the device. Figure 1A illustrates the proper connection for unipolar operation.

Bipolar operation is accomplished by offsetting the output amplifier A3 as shown in Figure 2A.

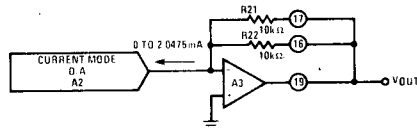

$$\begin{aligned}
 *V_{OUT} &= (I_{ZERO} \text{ to } I_{FULLSCALE}) \left( \frac{R21 - R22}{R21 + R22} \right) \\
 &= (0\text{mA to } 2.0475\text{mA}) (5\text{k}\Omega) \\
 &= 0\text{V to } +10.2375\text{V}
 \end{aligned}$$

\*Values shown are for V<sub>REF</sub> = 10.240V.

$$\begin{aligned}
 \text{1 LSB Voltage Step} &= \frac{10.240\text{V}}{4096} = 2.5\text{mV} \\
 \text{1 LSB Current Step} &= \frac{2.5\text{mV}}{5.0\text{k}\Omega} = 0.5\mu\text{A}
 \end{aligned}$$

FIGURE 1A. DAC1200/DAC1201 Unipolar Operation

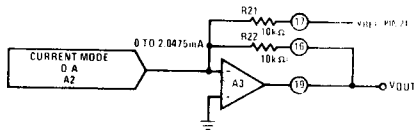

$$\begin{aligned}
 *V_{OUT} &= (0 \text{ to } 2.0475\text{mA})R22 - \frac{V_{REF}}{R22} R21 \\
 &= (0 \text{ to } 2.0475\text{mA})R22 - V_{REF}, R21 \equiv R22 \\
 &= -10.240 \text{ to } +10.235\text{V} \\
 * \text{Values shown are for } V_{REF} &= 10.240\text{V} \\
 1 \text{ LSB} &= 5\text{mV}
 \end{aligned}$$

FIGURE 2A. DAC1200/DAC1201 Bipolar Operation

External resistors may be used to achieve alternate zero and full-scale voltages. It is advantageous to utilize R21 and R22 even in these applications since they are closely matched in TCR and temperature to the internal array. Figure 3 illustrates the recommended circuit for zero to 5V operation. R<sub>EXT</sub> should be of metal film or wire-wound construction with a TCR of less than 10ppm/°C.

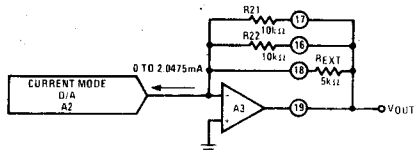

$$R_{TOTAL} = (R21 \parallel R22) \parallel (R_{EXT}) = \frac{V_{FULLSCALE}}{2.0475\text{mA}} = 2.5\text{k}\Omega$$

FIGURE 3. DAC1200 0 to 5.120V Operation

#### 4. Offset and Full-Scale Adjust

If higher precision is required in the zero and full-scale, external adjustments may be made. The circuit of figure 4 illustrates the recommended circuit to adjust offset and full-scale of the DAC1200 series. The circuit will work equally well for unipolar or bipolar operation.

In bipolar operation, the offset is adjusted at minus full-scale; in the unipolar case at zero scale.

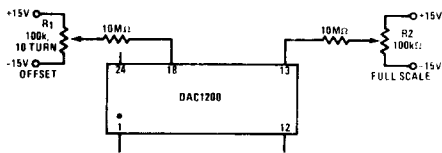

FIGURE 4. Offset & Full-Scale Adjust

For the values shown in figure 4, R1 will allow a ±7mV offset adjustment for the unipolar case and ±15mV for the bipolar case. R2 will allow a ±50mV adjustment of full scale.

#### 5. Current Mode Operation

Access to the summing junction of A3 affords current mode operation either with a resistive load or to drive a fast-settling external operational amplifier. The loop around A3 should not be closed in current mode operation. There is a ±2.5V maximum compliance voltage at A2's output (pin 18) which restricts the maximum size of the load resistor; i.e.,  $R_L \times I_{FULLSCALE} \leq 2.5\text{V}$ .

Note:  $I_{FULLSCALE} \approx 2\text{mA}$ .

#### 6. Settling Time & Glitch Minimization

The settling time of the DAC1200 series and the glitch which occurs between major input code changes may be improved by placing a 10 to 30pF capacitor between pins 18 (current-mode output) and 19 (voltage mode output). The capacitor is used to cancel output capacitance of the current mode D/A and stray capacitance at pin 18.

#### 7. Current Output Boosting

The DAC1200 series may be operated as a "power D/A" by including a current buffer such as the LH0002 or LH0063 in the loop with A3 as shown in figure 5.

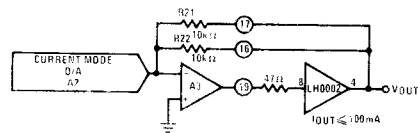

FIGURE 5. Current Boosted Output

#### 8. Logic Input Coding

The sense of the logic inputs to the DAC1200 series is complementary; i.e., a given bit is turned ON by an active "low" input. Table 1 summarizes input status for the unipolar and bipolar complementary binary and BCD codes.

Other input codes may also be used. For example, the two's complement code, which is used extensively in computer and microprocessor applications, may be converted to the DAC1200 complementary bipolar format by inverting all bits except the MSB. The inversion may be accomplished in the microprocessor by software control, or by hardware using standard hex-inverters.

#### 9. Reference Voltage

External reference voltages may be used with the DAC1200 series. Voltages other than 10.240 or 10.000V in the range of +5.0V to 11V will work satisfactorily for voltage mode operation. Full-scale voltage is always  $V_{REF} - 1 \text{ LSB}$  where  $1 \text{ LSB} = V_{REF}/4096$ . Full-scale current may be predicted by:

$$I_{FULLSCALE} = (V_{REF})(0.19995117)\text{mA}$$

CODE TYPE	(Note 8) INPUT CODE		OUTPUT STATE	OUTPUT VOLTAGE $V_{REF} = 10.240V$	OUTPUT CURRENT	
	MSB	LSB				
Unipolar Complementary Binary	0000	0000	0000	Full-Scale	+10.2375V	2.0475mA
	1111	1111	1110	1 LSB ON	+2.500mV	0.500 $\mu$ A
	1111	1111	1111	Zero Scale	Zero	Zero
Bipolar Complementary Binary	0000	0000	0000	Full-Scale	+10.235V	+1.0235mA
	0111	1111	1111	Half Full-Scale	-0.000V	0.000mA
	1111	1111	1110	1 LSB ON	-10.235V	-1.0235mA
	1111	1111	1111	Zero Scale	-10.240V	-1.0240mA

**Note 8:** Logic input sense is such that an active low ( $V_{IN} \leq 0.8V$ ) turns a given bit ON and is represented as a logic "0" in the table.

## Definition of Terms

### Resolution

Resolution is defined as the reciprocal of the number of discrete steps in the D/A output (as designed). It is directly related to the number of switches or bits within the D/A. For example, the DAC1200 has  $2^{12}$  or 4096 steps. Resolution may therefore be expressed variously as 12 bits, as 1 part in  $2^{12}$ , as 1 part in 4096, or as a percentage ( $1/4096 \times 100 = 0.0244\%$ ).

### Linearity Error

Linearity error is the maximum deviation from a straight line passing through the endpoints of the D/A transfer characteristic. It is measured after calibrating for zero and full-scale. The linearity error of the DAC1200 series is guaranteed to be less than  $\pm\frac{1}{2}$  LSB or 0.0122% of F.S. for the DAC1200/1200C and  $\pm 0.0488\%$  of F.S. for the DAC1201/DAC1201C. Linearity error is a design parameter intrinsic to the device and cannot be externally adjusted.

### Offset Voltage

Offset voltage is an output voltage other than zero volts for unipolar operation (and other than minus full-scale for bipolar operation) with all bits turned OFF. In the DAC1200 series this error resides primarily in the output amplifier, A3. Offset voltage is adjustable to zero as discussed in the applications section.

### Power Supply Sensitivity

Power supply sensitivity is a measure of the effect of power supply changes on the D/A full-scale output.

### Settling Time

Two settling time parameters are specified for the DAC1200 series. Full-scale settling time requires a zero to full-scale or full-scale to zero output change. One LSB settling time requires one LSB output change. In both instances, settling time is the time required from a code transition until the D/A output reaches within  $\pm\frac{1}{2}$  LSB of final output value.

### Monotonicity

Monotonicity is a characteristic of the D/A which requires a non-negative output step for an increasing input digital code. Monotonicity, therefore, demands no back steps or changes in sign of the slope of the D/A transfer characteristic.

### Full-Scale Error

Full-scale error is a measure of the output error between an ideal D/A and the actual device output. Ideally, for the DAC1200 full-scale is  $V_{REF} - 1$  LSB. For  $V_{REF} = 10.240V$  and unipolar operation,  $V_{FULLSCALE} = 10.240V - 2.5mV = 10.2375V$ . Departures from this value include internal gain, scaling, and reference errors. Full-scale error is adjustable to zero as discussed in the Applications section.

Typical Application

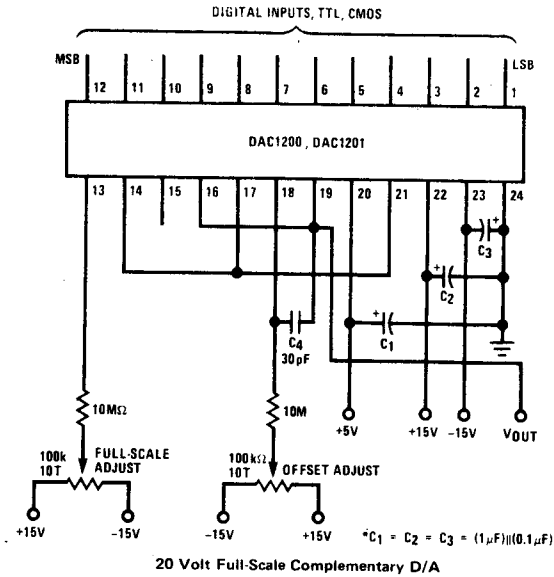

DC Test Circuit

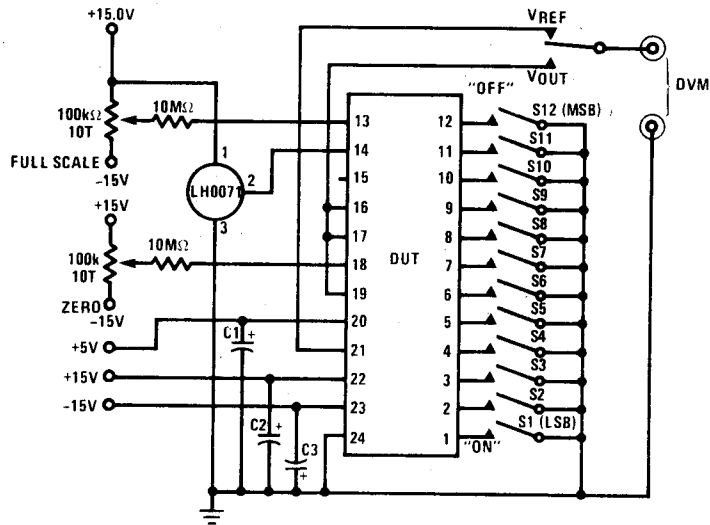

C1 = C2 = C3 = 4.7μF (solid tantalum) in parallel with a 0.01μF ceramic disc

Ordering Information

PART NUMBER	PACKAGE	25°C LINEARITY ERROR	OPERATING TEMPERATURE RANGE
DAC1200HD	Ceramic DIP	0.01%	-55°C to +125°C
DAC1201HD	Ceramic DIP	0.05%	-55°C to +125°C
DAC1200HCD	Ceramic DIP	0.01%	-25°C to +85°C
DAC1201HCD	Ceramic DIP	0.05%	-25°C to +85°C