

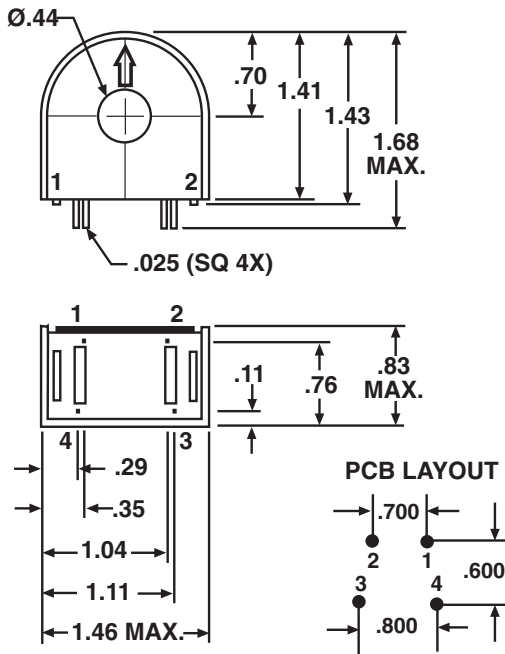

RL-7100

LOW COST 50/60 Hz CURRENT SENSORS



This series of current sensors offers standard accuracy at low cost. The molded aperture is a PC mountable design made to meet IEC 360 and other safety agency requirements when used with an insulated conductor. These 50/60 cycle CT's are capable of current ranges up to 200 Amps. Variations of this standard product can be accommodated.

Typical Applications:

- Switch gear/Switch board
- Load sensing
- Power demand monitoring
- Power failure
- Loss of device
- Status of loads

Features:

- Molded aperture for primary wire(s)
- Frequency range from 47-400 Hz
- Meets IEC, VDE and UL specifications
- Low cost

NOTES:

- I_p : Primary Current
- V/A: Output per input amps
- R_L : Terminating Resistor
- R_S : Winding resistance
- WT: Approximate net weight in grams.
- All materials conform to UL94-V0.
- Manufactured to UL class B insulation (130°C).
- Temperature Range: -55°C to +130°C
- Overload current rated for a 100 ohm terminating resistor.
- Overload current for RL-7100-25-100 rises to 50 amps when using a 50 ohm terminating resistor.
- The terminating resistor and the one-turn primary are customer supplied.
- Pins 3 and 4 are used for mechanical support, may also be used for center tap and other custom designs.

RENCO Part Number	I_p	$V_{out} (\pm 2\%)$	V/A	R_L		Turns Ratio	R_S	Frequency	Overload Current	Dielectric Withstanding	WT
				Ohms	Watts						
RL-7100-25-1000	0-25	2.5	0.1	100	0.25	1000:1	32.2	47-400	30	6000	30
RL-7100-50-1000	0-50	5	0.1	100	0.5	1000:1	63.3	47-400	65	6000	42
RL-7100-100-1000	0-100	10	0.1	100	1.0	1000:1	26.5	47-400	160	6000	57
RL-7100-200-1000	0-200	20	0.1	100	5.0	1000:1	16.3	47-400	250	6000	67



RENCO ELECTRONICS, INC.

✉ 595 International Place, Rockledge, FL 32955-4200 USA

☎ (321) 637-1000 • Toll Free Engineering Hot line 800-645-5828

📠 Fax: (321) 637-1600 🌐 Web Site: www.rencousa.com ✉ E-mail: sales@rencousa.com

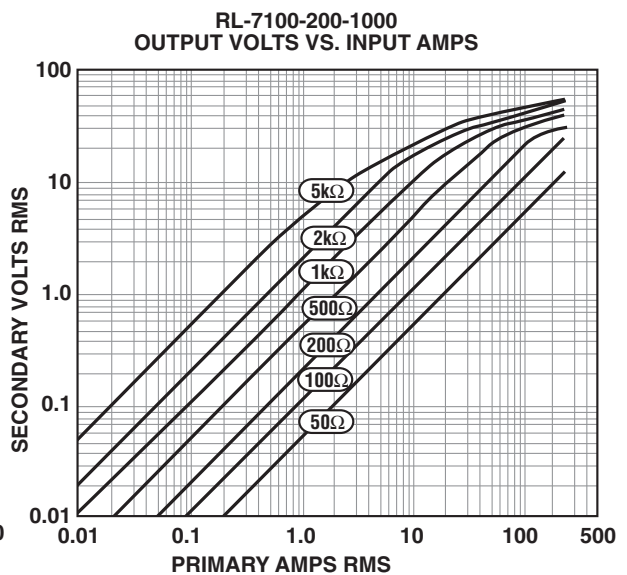
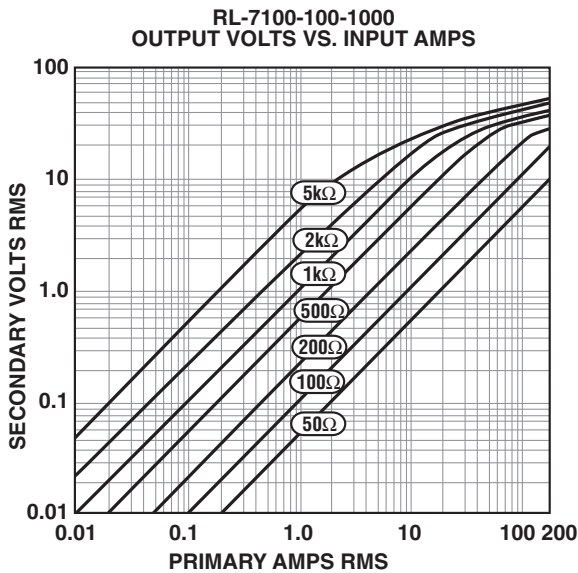
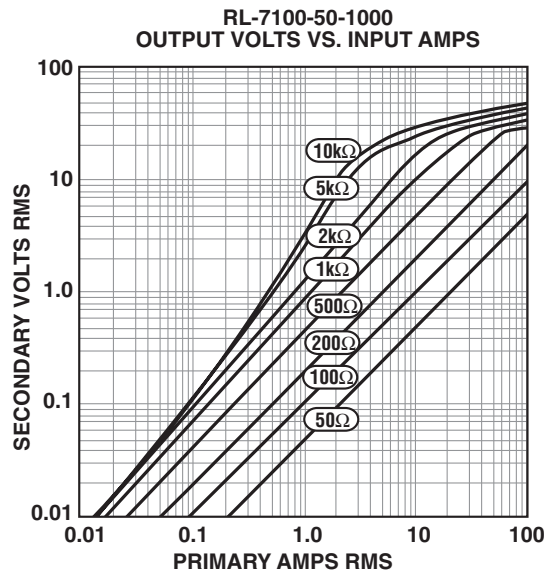
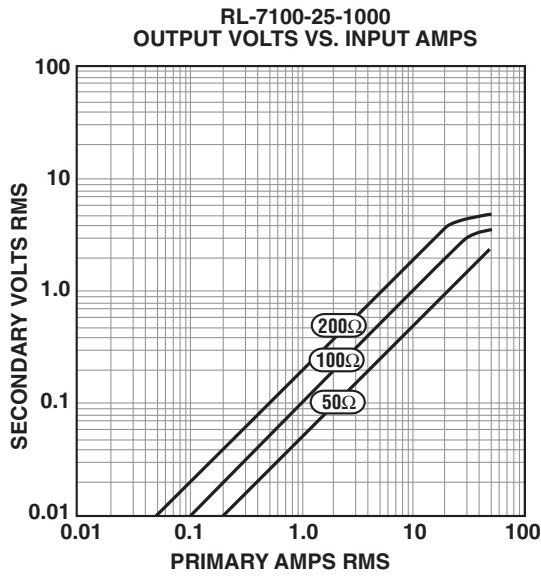
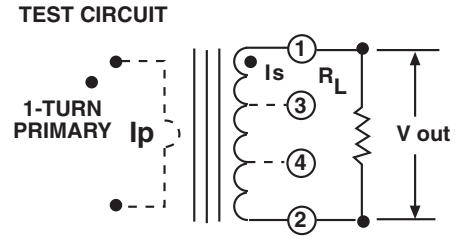
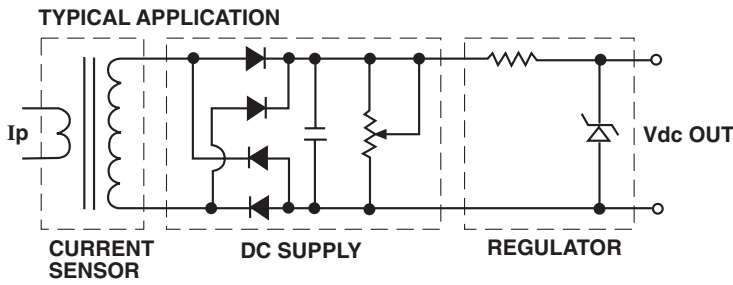
**RENCO ELECTRONICS, INC.**
SINCE 1955

RENCO ELECTRONICS, INC.

595 International Place, Rockledge, FL 32955-4200 USA

(321) 637-1000 • Toll Free Engineering Hot line 800-645-5828

Fax: (321) 637-1600 Web Site: www.rencousa.com E-mail: sales@rencousa.com