

TL066M, TL066I, TL066C, TL066AC, TL066BC ADJUSTABLE LOW-POWER JFET-INPUT OPERATIONAL AMPLIFIERS

D2494, FEBRUARY 1979—REVISED NOVEMBER 1988

5 DEVICES COVER COMMERCIAL, INDUSTRIAL, AND MILITARY TEMPERATURE RANGES

- Very Low, Adjustable ("Programmable") Power Consumption
- Adjustable Supply Current . . . 5 μA to 200 μA
- Very Low Input Bias and Offset Currents
- Wide Supply Range . . . $\pm 1.2\text{ V}$ to $\pm 18\text{ V}$
- Wide Common-Mode and Differential Voltage Range
- Output Short-Circuit Protection
- High Input Impedance . . . JFET-Input Stage
- Unity-Gain Bandwidth . . . 1 MHz Typ (100 kHz at 25 μW)
- High Slew Rate . . . 3.5 V/ μs Typ
- Internal Frequency Compensation
- Latch-Up-Free Operation
- Common-Mode Input Voltage Range Includes V_{CC+}

TL066M . . . JG PACKAGE
TL066I, TL066C, TL066AC, TL066BC . . . D, JG, OR P PACKAGE
(TOP VIEW)

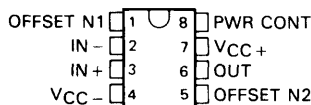

TL066M . . . FK PACKAGE
(TOP VIEW)

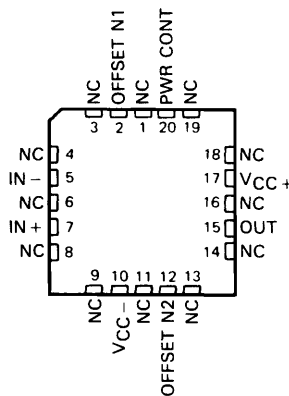

NC—No internal connection

TL066M IS NOT RECOMMENDED FOR NEW DESIGNS

description

The TL066, TL066A, and TL066B are JFET-input operational amplifiers similar to the TL061 with the additional feature of being power-adjustable. They feature very low input offset and bias currents, high input impedance, wide bandwidth, and high slew rate. The power-control feature permits the amplifiers to be adjusted to require as little as 25 μW of power. This type of amplifier, which provides for changing several characteristics by varying one external element, is sometimes referred to as being "programmable." The JFET-input stage combined with the adjustable-low-power feature results in superior bandwidth and slew-rate performance compared to low-power bipolar-input devices.

The TL066M is characterized for operation over the full military temperature range of -55°C to 125°C ; the TL066I is characterized for operation from -40°C to 85°C ; the TL066C, TL066AC, and TL066BC are characterized for operation from 0°C to 70°C .

symbol

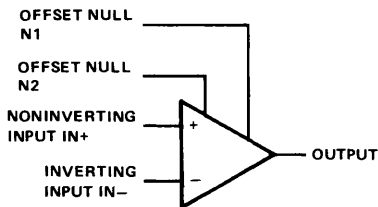

PRODUCTION DATA documents contain information current as of publication date. Products conform to specifications per the terms of Texas Instruments standard warranty. Production processing does not necessarily include testing of all parameters.

TEXAS
INSTRUMENTS

POST OFFICE BOX 655012 • DALLAS, TEXAS 75265

Copyright © 1983, Texas Instruments Incorporated

2-373

TL066M, TL066I, TL066C, TL066AC, TL066BC ADJUSTABLE LOW-POWER JFET-INPUT OPERATIONAL AMPLIFIERS

AVAILABLE OPTIONS

T _A	V _{IO} MAX AT 25°C	PACKAGE			
		SMALL-OUTLINE (D)	CHIP-CARRIER (FK)	CERAMIC DIP (JG)	PLASTIC DIP (P)
0°C to 70°C	15 mV 6 mV 3 mV	TL066CD TL066ACD TL066BCD		TL066CJG TL066ACJG TL066BCJG	TL066CP TL066ACP TL066BCP
-40°C to 85°C	6 mV	TL066ID		TL066IJG	TL066IP
-55°C to 125°C	6 mV		TL066MFK	TL066MJG	

The D package is available taped and reeled. Add the suffix "R" to the device type (e.g., TL066CDR).

2

Operational Amplifiers

schematic

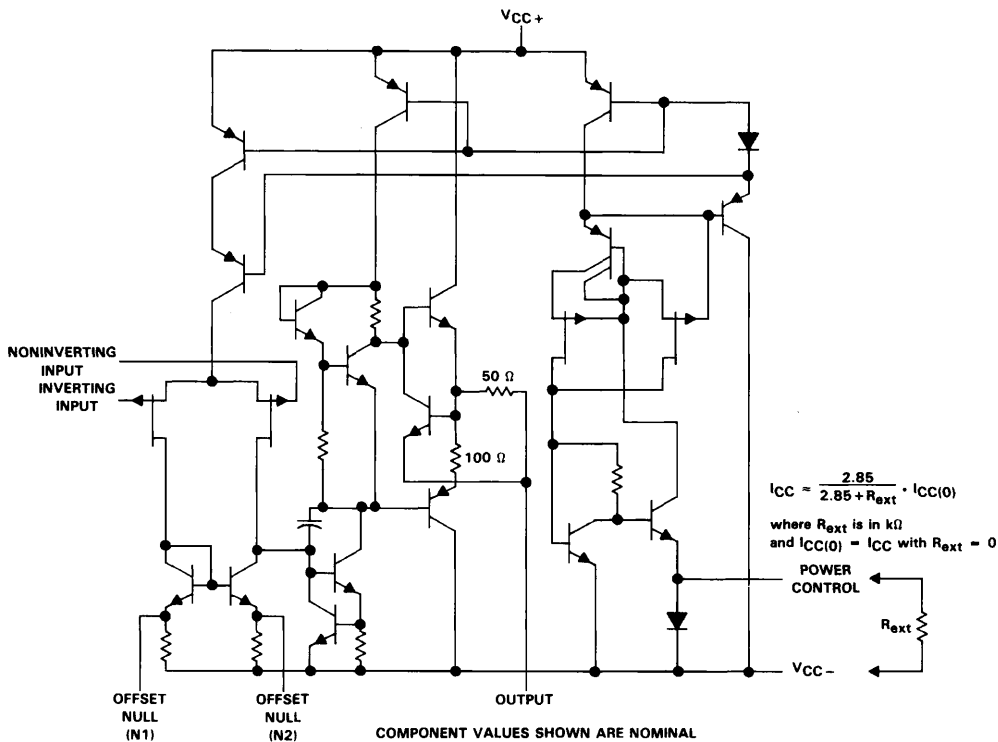

TL066M, TL066I, TL066C, TL066AC, TL066BC

ADJUSTABLE LOW-POWER JFET-INPUT OPERATIONAL AMPLIFIERS

absolute maximum ratings over operating free-air temperature range (unless otherwise noted)

		TL066M	TL066I	TL066C, TL066AC, TL066BC	UNIT
Supply voltage, V_{CC+} (see Note 1)		18	18	18	V
Supply voltage, V_{CC-} (see Note 1)		-18	-18	-18	V
Differential input voltage (see Note 2)		± 30	± 30	± 30	V
Input voltage (see Notes 1 and 3)		± 15	± 15	± 15	V
Voltage between power-control terminal and V_{CC-}		± 0.5	± 0.5	± 0.5	V
Duration of output short circuit (see Note 4)		unlimited	unlimited	unlimited	
Continuous total dissipation		See Dissipation Rating Table			
Operating free-air temperature range		-55 to 125	-40 to 85	0 to 70	°C
Storage temperature range		-65 to 150	-65 to 150	-65 to 150	°C
Case temperature for 60 seconds	FK package	260			°C
Lead temperature 1,6 mm (1/16 inch) from case for 60 seconds	JG package	300	300	300	°C
Lead temperature 1,6 mm (1/16 inch) from case for 10 seconds	D or P package		260	260	°C

- NOTES: 1. All voltage values, except differential voltages, are with respect to the midpoint between V_{CC+} and V_{CC-} .
 2. Differential voltages are at the noninverting input terminal with respect to the inverting input terminal.
 3. The magnitude of the input voltage must never exceed the magnitude of the supply voltage or 15 V, whichever is less.
 4. The output may be shorted to ground or to either supply. Temperature and/or supply voltages must be limited to ensure that the dissipation rating is not exceeded.

DISSIPATION RATING TABLE

PACKAGE	$T_A \leq 25^\circ\text{C}$	DERATING	DERATE	$T_A = 70^\circ\text{C}$	$T_A = 85^\circ\text{C}$	$T_A = 125^\circ\text{C}$
	POWER RATING	FACTOR	ABOVE T_A	POWER RATING	POWER RATING	POWER RATING
D	680 mW	5.8 mW/°C	33°C	464 mW	377 mW	N/A
FK	680 mW	11.0 mW/°C	88°C	680 mW	680 mW	275 mW
JG (TL066M)	680 mW	8.4 mW/°C	69°C	672 mW	546 mW	210 mW
JG (all others)	680 mW	6.6 mW/°C	47°C	528 mW	429 mW	N/A
P	680 mW	8.0 mW/°C	65°C	640 mW	520 mW	N/A

TL066M, TL066I, TL066C ADJUSTABLE LOW-POWER JFET-INPUT OPERATIONAL AMPLIFIERS

2 Operational Amplifiers

electrical characteristics, $V_{CC} = \pm 15\text{ V}$

PARAMETER	TEST CONDITIONS†	TL066M			TL066I			TL066C			UNIT
		MIN	TYP	MAX	MIN	TYP	MAX	MIN	TYP	MAX	
V_{IO} Input offset voltage	$V_O = 0$, $T_A = 25^\circ\text{C}$		3	6		3	6		3	15	mV
	$V_O = 0$, $T_A = \text{full range}$			9			9			20	
	$V_O = 0$, $T_A = \text{full range}$			10			10			10	
α_{VIO} Temperature coefficient of input offset voltage	$V_O = 0$, $T_A = \text{full range}$										$\mu\text{V}/^\circ\text{C}$
I_{IO} Input offset current‡	$V_O = 0$, $T_A = 25^\circ\text{C}$		5	100		5	100		5	200	pA
I_{IB} Input bias current‡	$V_O = 0$, $T_A = \text{full range}$			20			10			5	nA
	$V_O = 0$, $T_A = 25^\circ\text{C}$		30	200		30	200		30	400	pA
	$V_O = 0$, $T_A = \text{full range}$			50			20			10	nA
V_{ICR} Common-mode input voltage range	$T_A = 25^\circ\text{C}$	± 11.5	to $+15$		± 11.5	to $+15$		± 11	to $+15$		V
V_{OM} Maximum peak output voltage swing	$T_A = 25^\circ\text{C}$, $R_L \geq 10\text{ k}\Omega$	± 10	± 13.5		± 10	± 13.5		± 10	± 13.5		V
	$T_A = \text{full range}$, $R_L \geq 10\text{ k}\Omega$	± 10	± 13.5		± 10	± 13.5		± 10	± 13.5		V
	$R_L \geq 10\text{ k}\Omega$, $T_A = 25^\circ\text{C}$	4	6		4	6		3	6		V/mV
AVD Large-signal differential voltage amplification	$R_L \geq 10\text{ k}\Omega$, $T_A = 25^\circ\text{C}$	4	4		4	4		3	3		V/mV
	$R_L \geq 10\text{ k}\Omega$, $T_A = \text{full range}$	4	4		4	4		3	3		V/mV
	$T_A = 25^\circ\text{C}$, $R_L = 10\text{ k}\Omega$		1			1			1		MHz
r_i Input resistance	$T_A = 25^\circ\text{C}$		10 ¹²			10 ¹²			10 ¹²		Ω
r_o Output resistance	$T_A = 25^\circ\text{C}$, $f = 1\text{ kHz}$		220			220			220		Ω
CMRR Common-mode rejection ratio	$V_{IC} = V_{ICR\text{ min}}$, $V_O = 0$, $R_S = 50\ \Omega$, $T_A = 25^\circ\text{C}$	80	86		80	86		70	76		dB
k_{SVR} Supply voltage rejection ratio ($\Delta V_{CC} \pm / \Delta V_{IO}$)	$V_{CC} = \pm 9\text{ V}$ to $\pm 15\text{ V}$, $V_O = 0$, $R_S = 50\ \Omega$, $T_A = 25^\circ\text{C}$	80	95		80	95		70	95		dB
P_D Total power dissipation	$V_O = 0$, $T_A = 25^\circ\text{C}$		6	7.5		6	7.5		6	7.5	mW
I_{CC} Supply current	$V_O = 0$, $T_A = 25^\circ\text{C}$		200	250		200	250		200	250	μA

† All characteristics are measured under open-loop conditions with zero common-mode input voltage unless otherwise specified. Full range of T_A is -55°C to 125°C for TL066M; -40°C to 85°C for TL066I; and 0°C to 70°C for TL066C. The electrical parameters are measured with the power-control terminal (pin 8) connected to V_{CC} .

‡ Input bias currents of a JFET-input operational amplifier are normal junction reverse currents, which are temperature-sensitive. Pulse techniques must be used that will maintain the junction temperature as close to the ambient temperature as is possible.

TL066AC, TL066BC ADJUSTABLE LOW-POWER JFET-INPUT OPERATIONAL AMPLIFIERS

electrical characteristics, $V_{CC} = \pm 15 \text{ V}$

PARAMETER	TEST CONDITIONS†	TL066AC			TL066BC			UNIT
		MIN	TYP	MAX	MIN	TYP	MAX	
V_{IO} Input offset voltage	$V_O = 0$, $T_A = 25^\circ\text{C}$, $R_S = 50 \Omega$		3	6		2	3	mV
	$V_O = 0$, $T_A = \text{full range}$, $R_S = 50 \Omega$			7.5			5	
αV_{IO} Temperature coefficient of input offset voltage	$V_O = 0$, $T_A = \text{full range}$, $R_S = 50 \Omega$		10			10		$\mu\text{V}/^\circ\text{C}$
I_{IO} Input offset current‡	$V_O = 0$, $T_A = 25^\circ\text{C}$		5	100		5	100	pA
	$V_O = 0$, $T_A = \text{full range}$			3			3	nA
I_{IB} Input bias current‡	$V_O = 0$, $T_A = 25^\circ\text{C}$		30	200		30	200	pA
	$V_O = 0$, $T_A = \text{full range}$			7			7	nA
V_{ICR} Common-mode input voltage range	$T_A = 25^\circ\text{C}$	± 11.5	-12 to ± 15		± 11.5	-12 to ± 15		V
V_{OM} Maximum peak output voltage swing	$T_A = 25^\circ\text{C}$, $R_L \geq 10 \text{ k}\Omega$	± 10	± 13.5		± 10	± 13.5		V
	$T_A = \text{full range}$, $R_L \geq 10 \text{ k}\Omega$	± 10	± 13.5		± 10	± 13.5		
A_{VD} Large-signal differential voltage amplification	$R_L \geq 10 \text{ k}\Omega$, $T_A = 25^\circ\text{C}$, $V_O = \pm 10 \text{ V}$	4	6		4	6		V/mV
	$R_L \geq 10 \text{ k}\Omega$, $T_A = \text{full range}$, $V_O = \pm 10 \text{ V}$	4			4			
B_1 Unity-gain bandwidth	$T_A = 25^\circ\text{C}$, $R_L = 10 \text{ k}\Omega$		1			1		MHz
r_i Input resistance	$T_A = 25^\circ\text{C}$		10^{12}			10^{12}		Ω
r_o Output resistance	$T_A = 25^\circ\text{C}$, $f = 1 \text{ kHz}$		220			220		Ω
CMRR Common-mode rejection ratio	$V_{IC} = V_{ICR \text{ min}}$, $R_S = 50 \Omega$, $V_O = 0$, $T_A = 25^\circ\text{C}$	80	86		80	86		dB
k_{SVR} Supply voltage rejection ratio ($\Delta V_{CC} \pm \Delta V_{IO}$)	$V_{CC} = \pm 9 \text{ V to } \pm 15 \text{ V}$, $R_S = 50 \Omega$, $V_O = 0$, $T_A = 25^\circ\text{C}$	80	95		80	95		dB
P_D Total power dissipation	No load, $T_A = 25^\circ\text{C}$, $V_O = 0$		6	7.5		6	7.5	mW
I_{CC} Supply current	No load, $T_A = 25^\circ\text{C}$, $V_O = 0$		200	250		200	250	μA

† All characteristics are measured under open-loop conditions with zero common-mode input voltage unless otherwise specified. Full range of T_A is -55°C to 125°C for TL066M; -40°C to 85°C for TL066I; and 0°C to 70°C for TL066C, TL066AC, and TL066BC. The electrical parameters are measured with the power-control terminal (pin 8) connected to V_{CC-} .

‡ Input bias currents of a FET-input operational amplifier are normal junction reverse currents, which are temperature-sensitive. Pulse techniques must be used that will maintain the junction temperature as close to the ambient temperature as is possible.

2

Operational Amplifiers

TL066M, TL066I, TL066C, TL066C, TL066BC
ADJUSTABLE LOW-POWER JFET-INPUT OPERATIONAL AMPLIFIERS

operating characteristics, $V_{CC\pm} = \pm 15\text{ V}$, $T_A = 25^\circ\text{C}$, $R_{ext} = 0$

PARAMETER	TEST CONDITIONS	MIN	TYP	MAX	UNIT
SR Slew rate at unity gain	$V_I = 10\text{ V}$, $R_L = 10\text{ k}\Omega$, $C_L = 100\text{ pF}$, See Figure 1	1.5	3.5		$\text{V}/\mu\text{s}$
t_r Rise time	$V_I = 20\text{ mV}$, $R_L = 10\text{ k}\Omega$		0.2		μs
Overshoot factor	$C_L = 100\text{ pF}$, See Figure 1		10%		
V_n Equivalent input noise voltage	$R_S = 100\ \Omega$, $f = 1\text{ kHz}$		42		$\text{nV}/\sqrt{\text{Hz}}$

2

Operational Amplifiers

PARAMETER MEASUREMENT INFORMATION

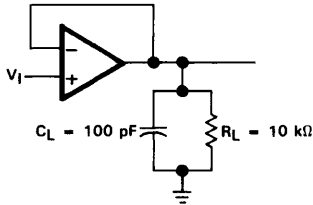

FIGURE 1. UNITY-GAIN AMPLIFIER

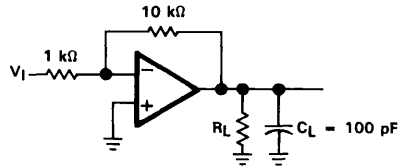

FIGURE 2. GAIN-OF-10 INVERTING AMPLIFIER

INPUT OFFSET VOLTAGE NULL CIRCUIT

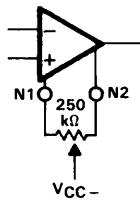

FIGURE 3

TL066M, TL066I, TL066C, TL066AC, TL066BC
ADJUSTABLE LOW-POWER JFET-INPUT OPERATIONAL AMPLIFIERS

TYPICAL CHARACTERISTICS†

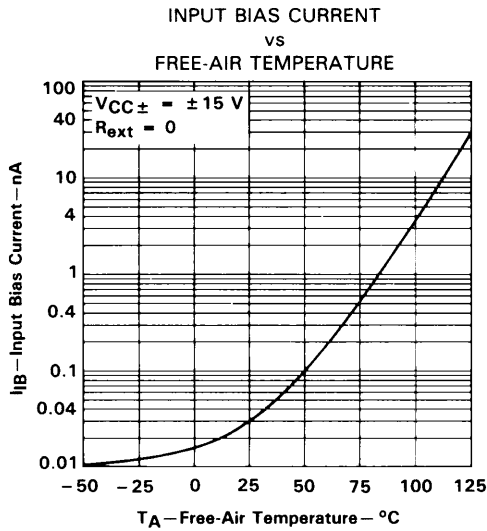

FIGURE 4

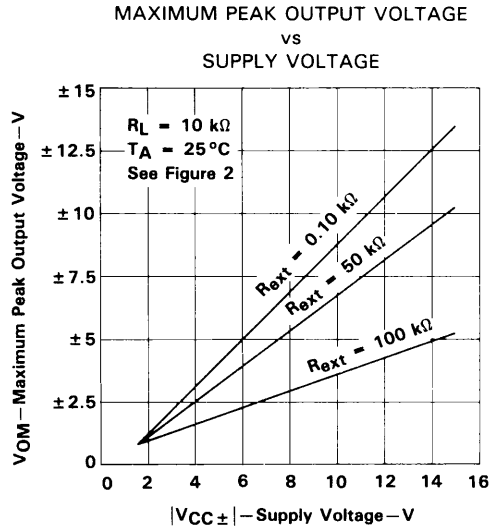

FIGURE 5

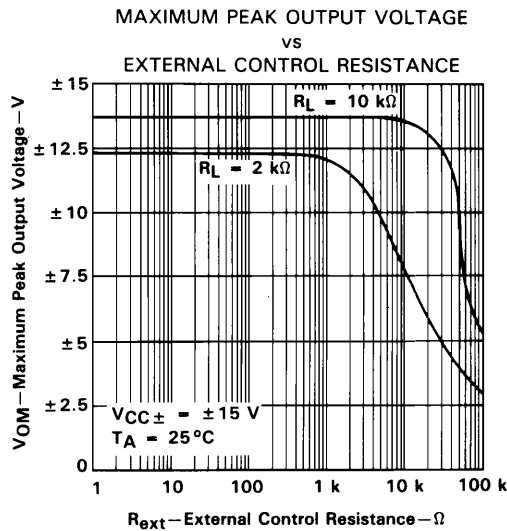

FIGURE 6

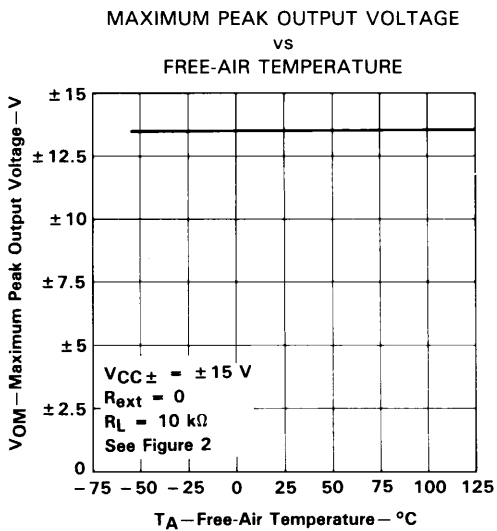

FIGURE 7

† Data at high and low temperatures are applicable only within the rated free-air temperature ranges of the various devices.

TL066M, TL066I, TL066C, TL066AC, TL066BC
ADJUSTABLE LOW-POWER JFET-INPUT OPERATIONAL AMPLIFIERS

TYPICAL CHARACTERISTICS†

2
Operational Amplifiers

MAXIMUM PEAK OUTPUT VOLTAGE
 vs
 LOAD RESISTANCE

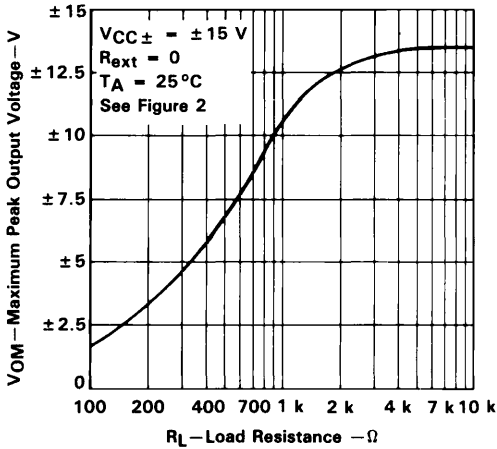

FIGURE 8

MAXIMUM PEAK OUTPUT VOLTAGE
 vs
 FREQUENCY

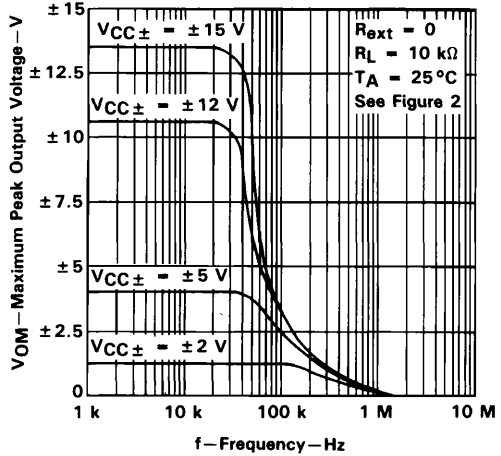

FIGURE 9

DIFFERENTIAL VOLTAGE AMPLIFICATION
 vs
 EXTERNAL CONTROL RESISTANCE

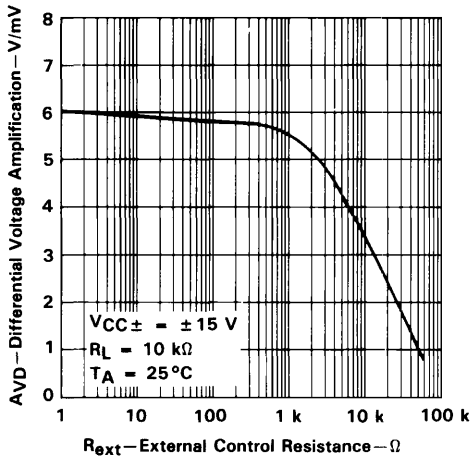

FIGURE 10

DIFFERENTIAL VOLTAGE AMPLIFICATION
 vs
 FREE-AIR TEMPERATURE

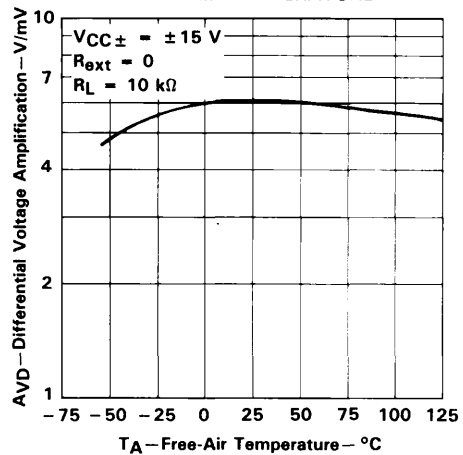

FIGURE 11

†Data at high and low temperatures are applicable only within the rated free-air temperature ranges of the various devices.

TL066M, TL066I, TL066C, TL066AC, TL066BC
ADJUSTABLE LOW-POWER JFET-INPUT OPERATIONAL AMPLIFIERS

TYPICAL CHARACTERISTICS†

LARGE SIGNAL
DIFFERENTIAL VOLTAGE AMPLIFICATION
AND PHASE SHIFT
vs
FREQUENCY

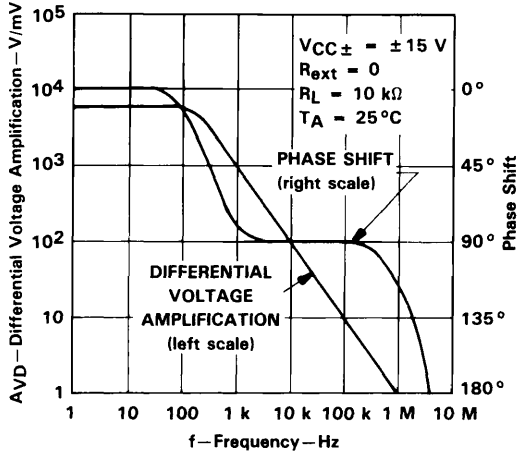

FIGURE 12

SUPPLY CURRENT
vs
SUPPLY VOLTAGE

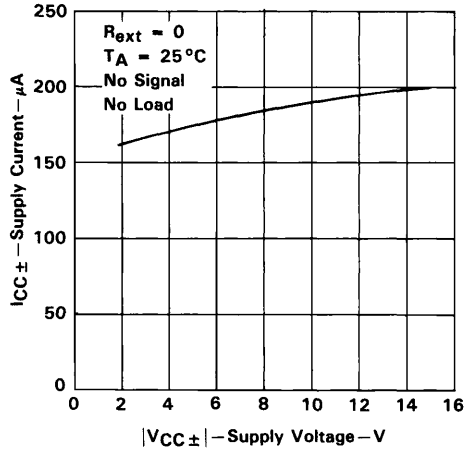

FIGURE 13

SUPPLY CURRENT
vs
EXTERNAL CONTROL RESISTANCE

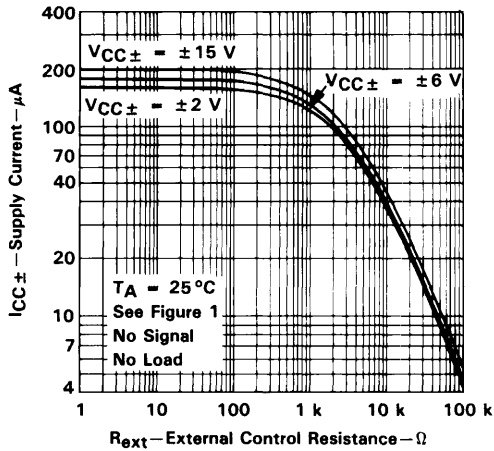

FIGURE 14

SUPPLY CURRENT
vs
FREE-AIR TEMPERATURE

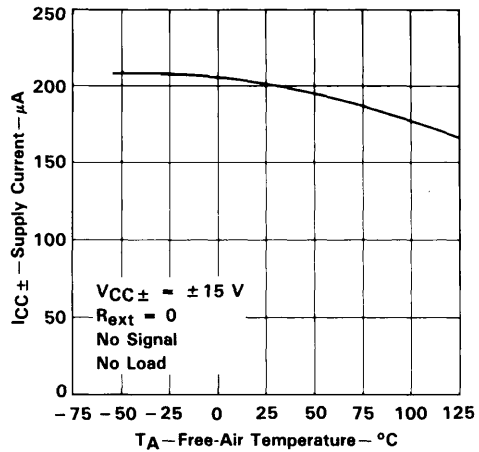

FIGURE 15

†Data at high and low temperatures are applicable only within the rated free-air temperature ranges of the various devices.

TL066M, TL066I, TL066C, TL066AC, TL066BC
ADJUSTABLE LOW-POWER JFET-INPUT OPERATIONAL AMPLIFIERS

TYPICAL CHARACTERISTICS†

2
Operational Amplifiers

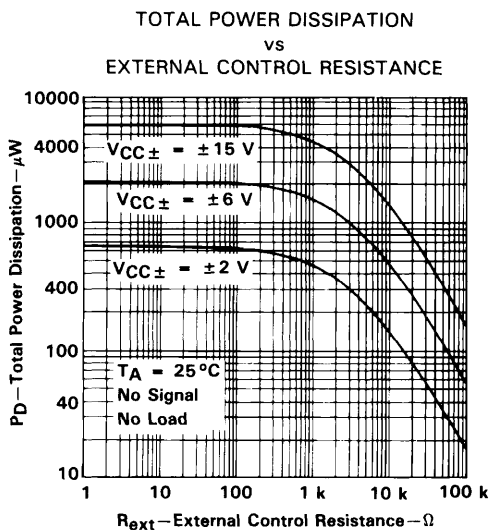

FIGURE 16

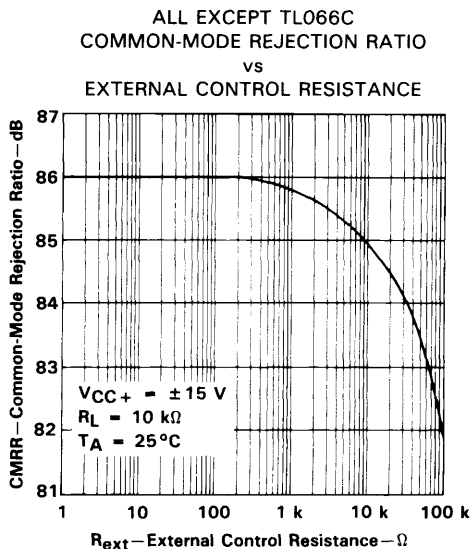

FIGURE 17

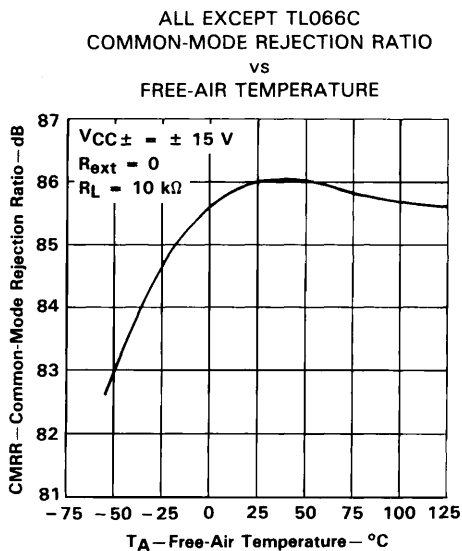

FIGURE 18

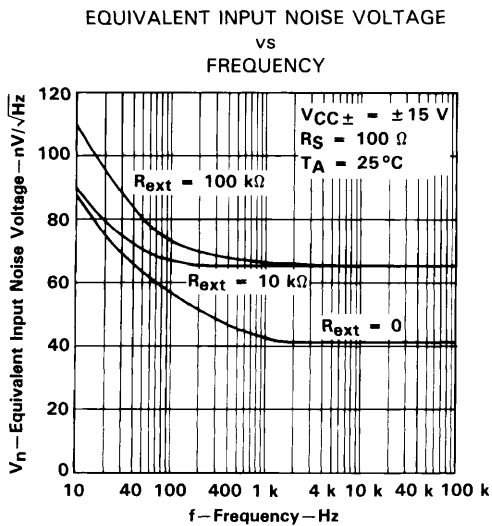
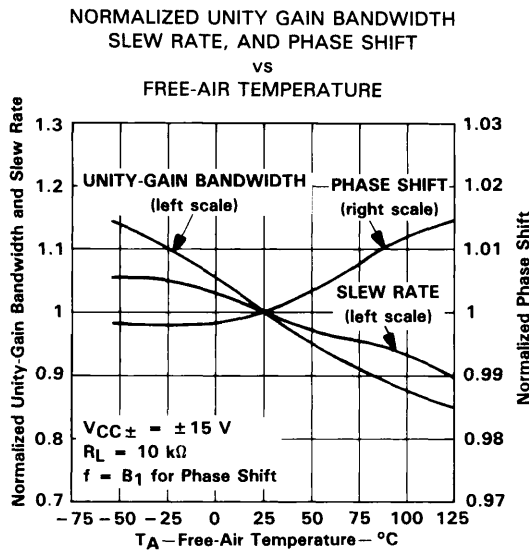
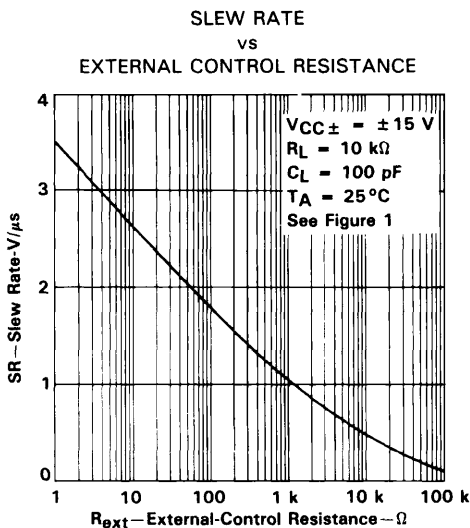
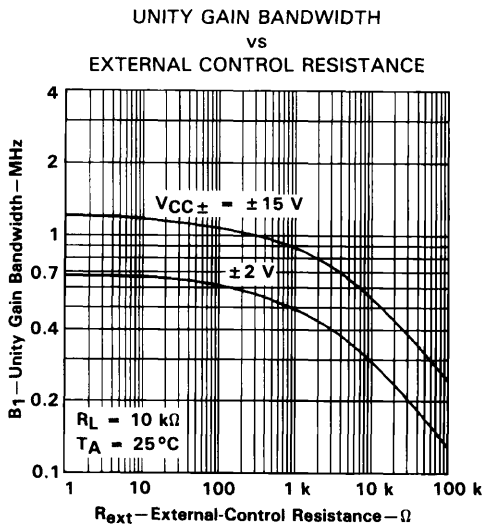
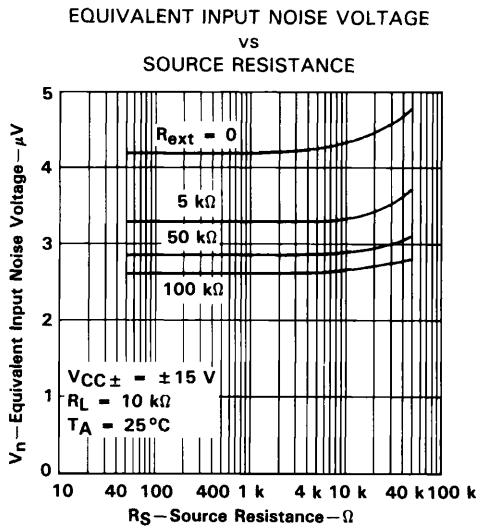

FIGURE 19

†Data at high and low temperatures are applicable only within the rated free-air temperature ranges of the various devices.

TL066M, TL066I, TL066C, TL066AC, TL066BC
ADJUSTABLE LOW-POWER JFET-INPUT OPERATIONAL AMPLIFIERS

TYPICAL CHARACTERISTICS†



†Data at high and low temperatures are applicable only within the rated free-air temperature ranges of the various devices.

TL066M, TL066I, TL066C, TL066AC, TL066BC
ADJUSTABLE LOW-POWER JFET-INPUT OPERATIONAL AMPLIFIERS

TYPICAL CHARACTERISTICS†

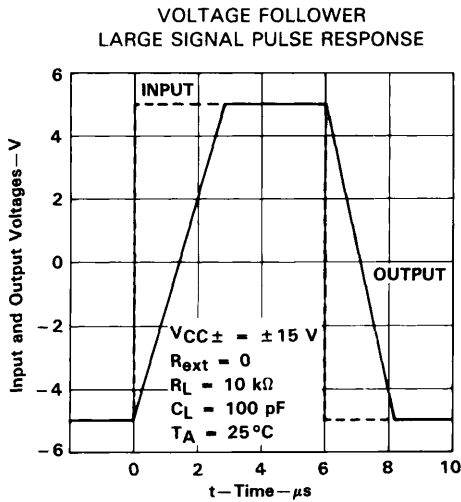

FIGURE 24

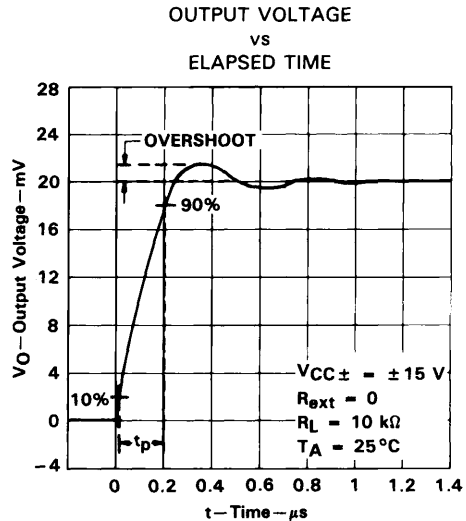

FIGURE 25

†Data at high and low temperatures are applicable only within the rated free-air temperature ranges of the various devices.

2
 Operational Amplifiers

TYPICAL APPLICATION DATA

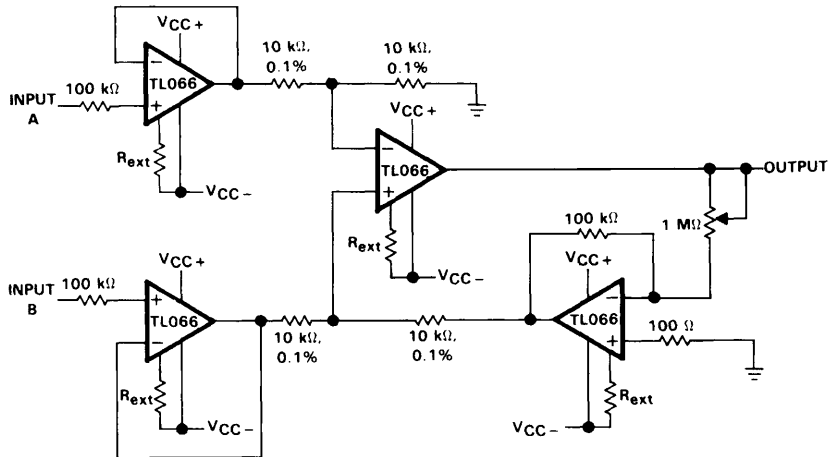

FIGURE 26. INSTRUMENTATION AMPLIFIER

TL066M, TL066I, TL066C, TL066AC, TL066BC
ADJUSTABLE LOW-POWER JFET-INPUT OPERATIONAL AMPLIFIERS

TYPICAL APPLICATION DATA

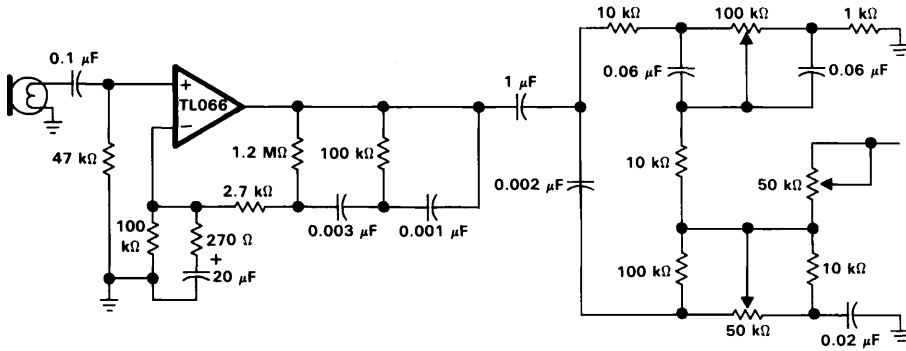

FIGURE 27. MICROPHONE PREAMPLIFIER WITH TONE CONTROL

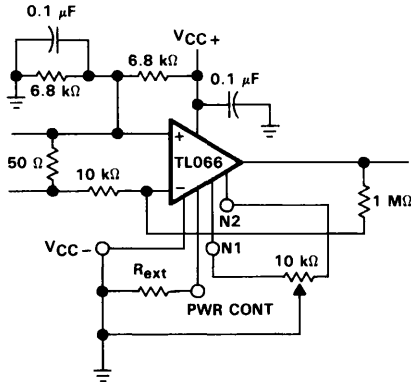

FIGURE 28. AC AMPLIFIER

TL066AC, TL066BC
ADJUSTABLE LOW-POWER JFET-INPUT OPERATIONAL AMPLIFIERS

2

Operational Amplifiers

TYPICAL APPLICATION DATA

IC PREAMPLIFIER RESPONSE CHARACTERISTICS

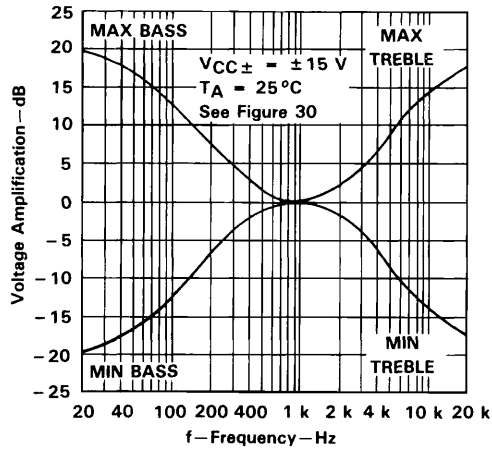

FIGURE 29

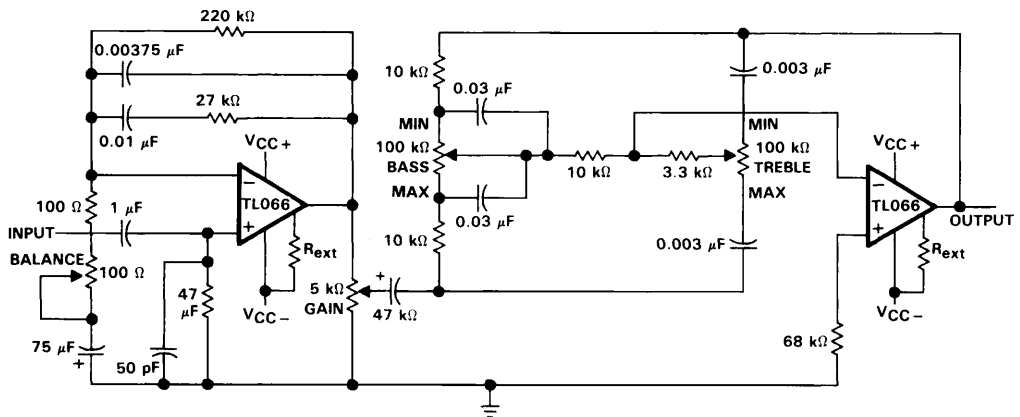

FIGURE 30. IC PREAMPLIFIER