

**SANYO****FH202****VCO OSC Circuit Applications****Features**

- Composite type with a buffer transistor (2SC5226) and an oscillator transistors (TS4162) contained in the currently provided MCP package as a VCO oscillator, improving the mounting efficiency greatly.
- The FH202 is formed with two chips, being equivalent to the 2SC5245 and TS4162, placed in one package.
- Optimal for use in oscillator circuit for VHF to UHF band.

**Package Dimensions**

unit:mm

2160

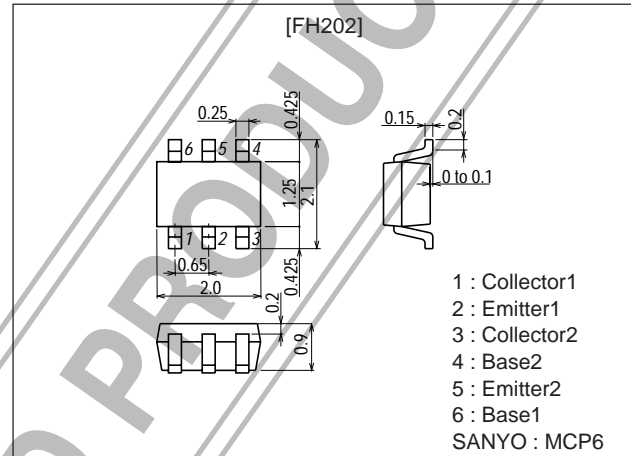
**Specifications****Absolute Maximum Ratings** at Ta = 25°C

Parameter	Symbol	Conditions	Ratings	Unit
Tr1 [2SC5226]				
Collector-to-Base Voltage	V <sub>CB0</sub>		20	V
Collector-to-Emitter Voltage	V <sub>CEO</sub>		10	V
Emitter-to-Base Voltage	V <sub>EB0</sub>		2	V
Collector Current	I <sub>C</sub>		70	mA
Collector Dissipation	P <sub>C</sub>		150	mW
Tr2 [TS4162]				
Collector-to-Base Voltage	V <sub>CB0</sub>		20	V
Collector-to-Emitter Voltage	V <sub>CEO</sub>		12	V
Emitter-to-Base Voltage	V <sub>EB0</sub>		2	V
Collector Current	I <sub>C</sub>		50	mA
Collector Dissipation	P <sub>C</sub>		150	mW
[Common specifications]				
Total Dissipation	P <sub>T</sub>		200	mW
Junction Temperature	T <sub>J</sub>		150	°C
Storage Temperature	T <sub>stg</sub>		-55 to +150	°C

■ Any and all SANYO products described or contained herein do not have specifications that can handle applications that require extremely high levels of reliability, such as life-support systems, aircraft's control systems, or other applications whose failure can be reasonably expected to result in serious physical and/or material damage. Consult with your SANYO representative nearest you before using any SANYO products described or contained herein in such applications.

■ SANYO assumes no responsibility for equipment failures that result from using products at values that exceed, even momentarily, rated values (such as maximum ratings, operating condition ranges, or other parameters) listed in products specifications of any and all SANYO products described or contained herein.

**SANYO Electric Co.,Ltd. Semiconductor Company**

TOKYO OFFICE Tokyo Bldg., 1-10, 1 Chome, Ueno, Taito-ku, TOKYO, 110-8534 JAPAN

# FH202

## Electrical Characteristics at Ta = 25°C

Parameter	Symbol	Conditions	Ratings			Unit
			min	typ	max	
<b>Tr1 [2SC5226]</b>						
Collector Cutoff Current	$I_{CBO}$	$V_{CB}=10V, I_E=0$			1.0	$\mu A$
Emitter Cutoff Current	$I_{EBO}$	$V_{EB}=1V, I_C=0$			10	$\mu A$
DC Current Gain	$h_{FE}$	$V_{CE}=5V, I_C=20mA$	90		200	
Gain-Bandwidth Product	$f_T$	$V_{CE}=5V, I_C=20mA$		7		GHz
Output Capacitance	$C_{ob}$	$V_{CB}=10V, f=1MHz$		0.75	1.2	pF
Forward Transfer Gain	$ S_{21e} ^2$	$V_{CE}=5V, I_C=20mA, f=1GHz$	9	12		dB
Noise Figure	NF	$V_{CE}=5V, I_C=7mA, f=1GHz$		1.0	1.8	dB
<b>Tr2 [TS4162]</b>						
Collector Cutoff Current	$I_{CBO}$	$V_{CB}=10V, I_E=0$			1.0	$\mu A$
Emitter Cutoff Current	$I_{EBO}$	$V_{EB}=1V, I_C=0$			10	$\mu A$
DC Current Gain	$h_{FE1}$	$V_{CE}=2V, I_C=3mA$	80		200	
	$h_{FE2}$	$V_{CE}=2V, I_C=50mA$	70			
Gain-Bandwidth Product	$f_T$	$V_{CE}=2V, I_C=3mA$	1.0	1.7		GHz
Output Capacitance	$C_{ob}$	$V_{CB}=10V, f=1MHz$		1.1	1.8	pF
Forward Transfer Gain	$ S_{21e} ^2$	$V_{CE}=2V, I_C=3mA, f=150MHz$	13	16		dB
Noise Figure	NF	$V_{CE}=2V, I_C=3mA, f=150MHz$		1.8	3.0	dB

Marking : 202

### Electrical Connection

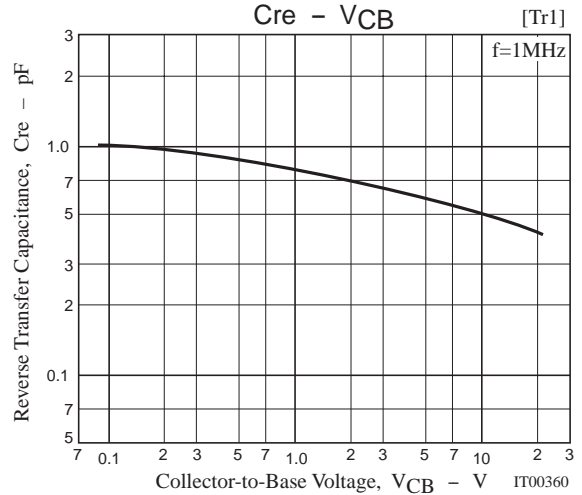
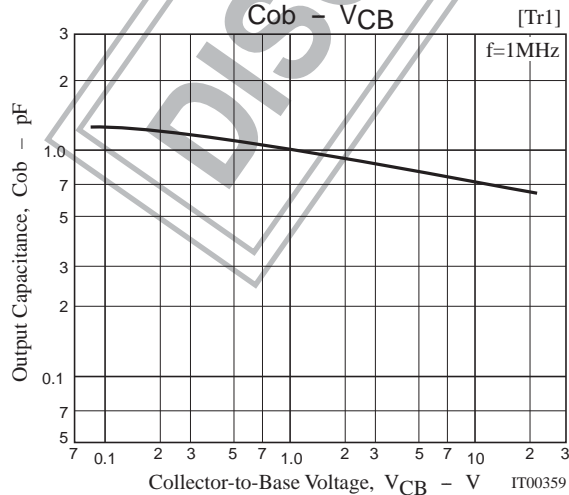
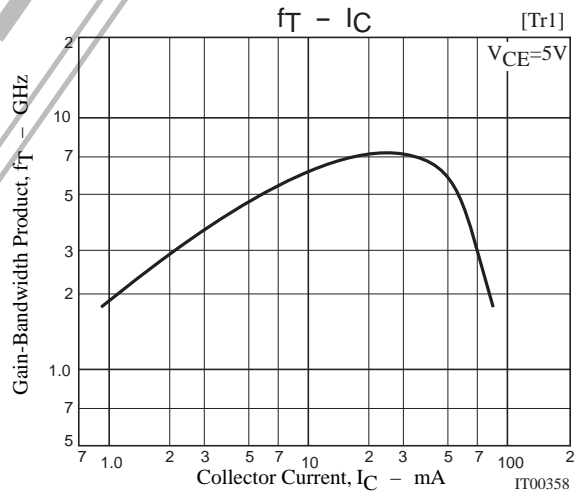
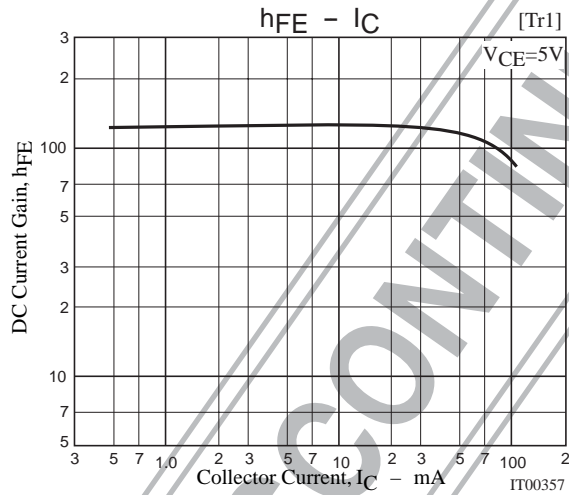
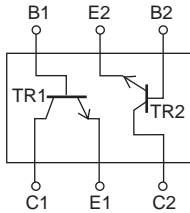

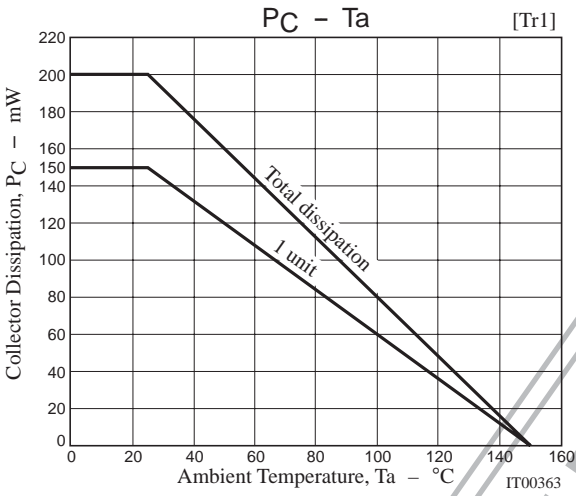
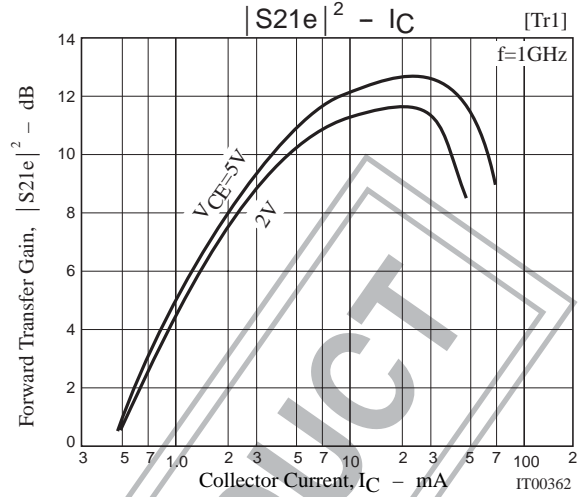
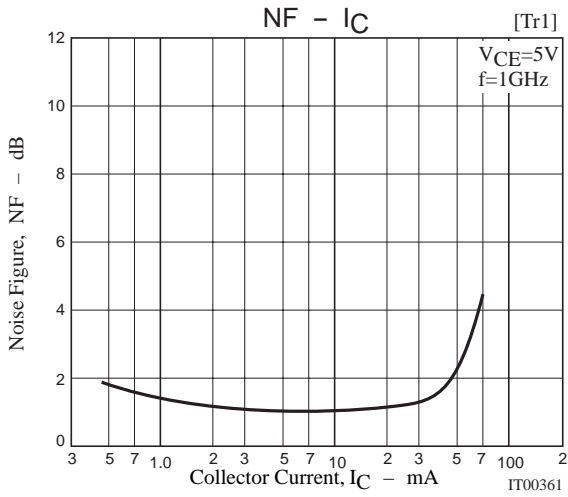

DISCONTINUED PRODUCT

S parameter [Tr1]

f=100MHz, 200MHz to 2000MHz(200MHz Step)

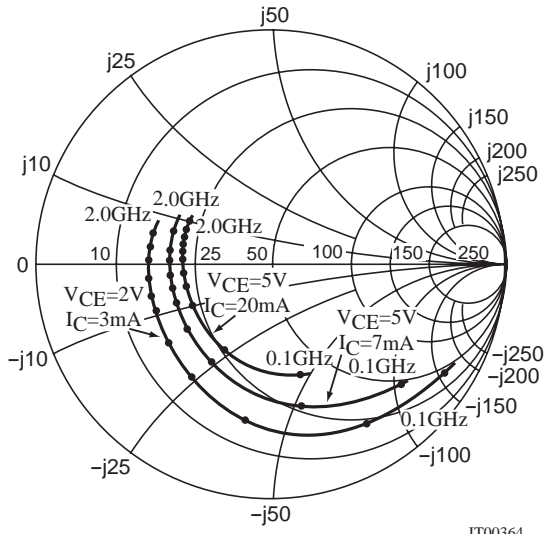

IT00364

f=100MHz, 200MHz to 2000MHz(200MHz Step)  
0.1GHz

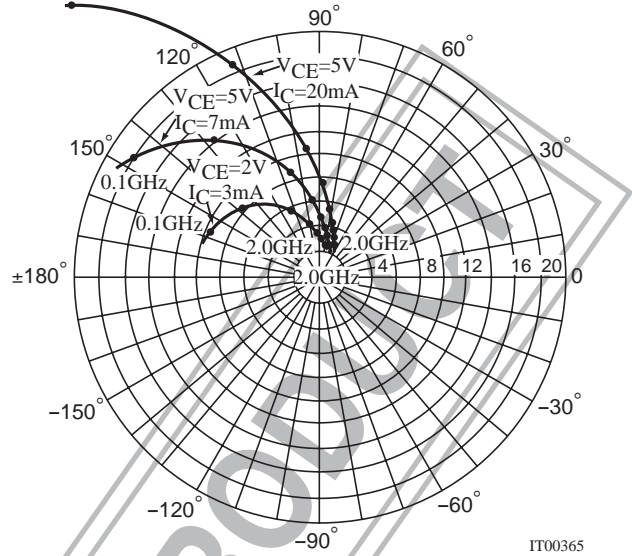

IT00365

f=100MHz, 200MHz to 2000MHz(200MHz Step)

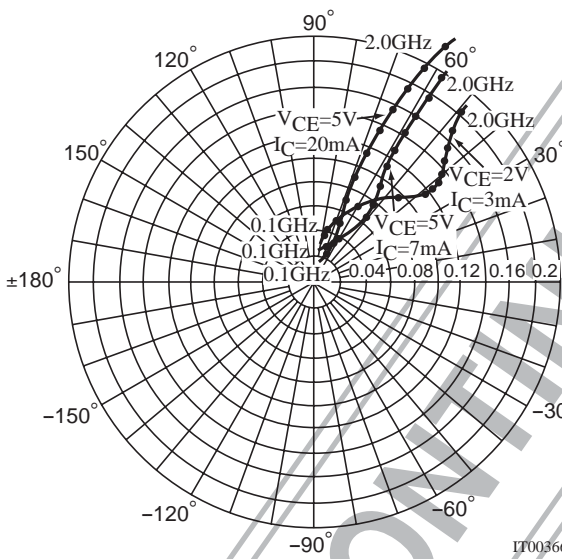

IT00366

f=100MHz, 200MHz to 2000MHz(200MHz Step)

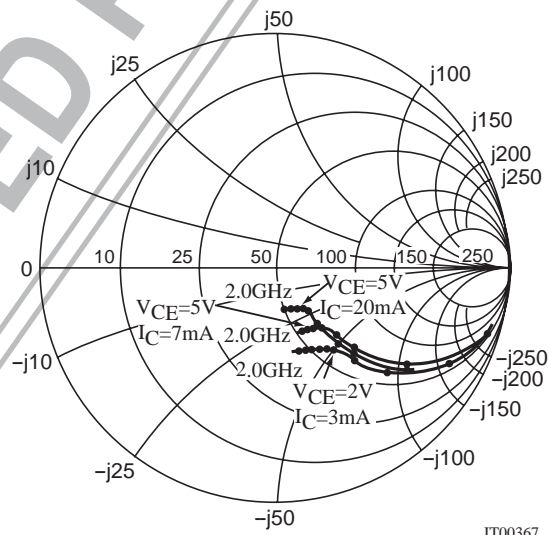

IT00367

DISCONTINUED PRODUCT

## FH202

### S Parameters (Common emitter) [Tr1]

$V_{CE}=5V, I_C=7mA, Z_O=50\Omega$

Freq (MHz)	$ S_{11} $	$\angle S_{11}$	$ S_{21} $	$\angle S_{21}$	$ S_{12} $	$\angle S_{12}$	$ S_{22} $	$\angle S_{22}$
100	0.720	-46.0	17.973	148.5	0.030	68.5	0.880	-23.6
200	0.612	-80.9	13.927	127.3	0.047	57.1	0.697	-37.6
400	0.497	-121.3	8.656	105.0	0.066	51.3	0.479	-47.6
600	0.456	-143.5	6.080	92.8	0.079	52.9	0.382	-50.5
800	0.440	-157.6	4.725	84.3	0.094	55.4	0.339	-51.8
1000	0.436	-167.5	3.864	77.0	0.110	56.8	0.323	-53.4
1200	0.434	-176.1	3.258	70.3	0.126	57.9	0.312	-55.8
1400	0.433	-176.6	2.847	64.5	0.143	58.4	0.304	-58.3
1600	0.433	-170.9	2.329	57.4	0.160	58.9	0.296	-62.0
1800	0.434	-165.0	2.252	54.2	0.178	58.6	0.293	-65.0
2000	0.439	-159.6	2.057	49.2	0.197	58.1	0.294	-68.1

$V_{CE}=5V, I_C=20mA, Z_O=50\Omega$

Freq (MHz)	$ S_{11} $	$\angle S_{11}$	$ S_{21} $	$\angle S_{21}$	$ S_{12} $	$\angle S_{12}$	$ S_{22} $	$\angle S_{22}$
100	0.481	-78.8	29.795	132.9	0.022	63.9	0.707	-38.2
200	0.420	-119.2	19.008	112.2	0.033	60.8	0.470	-51.1
400	0.391	-151.6	10.416	95.4	0.052	64.7	0.296	-55.3
600	0.386	-166.4	7.084	86.6	0.071	67.2	0.236	-56.1
800	0.381	-175.9	5.407	80.1	0.092	68.4	0.213	-56.6
1000	0.382	178.2	4.401	74.1	0.114	67.8	0.208	-57.9
1200	0.385	172.1	3.701	68.5	0.134	66.8	0.204	-60.7
1400	0.388	166.7	3.217	63.6	0.156	65.6	0.202	-63.5
1600	0.390	162.1	2.839	58.8	0.176	64.0	0.199	-67.9
1800	0.391	156.7	2.534	54.3	0.197	62.4	0.197	-71.2
2000	0.394	152.1	2.319	50.1	0.219	60.6	0.197	-74.2

$V_{CE}=2V, I_C=3mA, Z_O=50\Omega$

Freq (MHz)	$ S_{11} $	$\angle S_{11}$	$ S_{21} $	$\angle S_{21}$	$ S_{12} $	$\angle S_{12}$	$ S_{22} $	$\angle S_{22}$
100	0.858	-32.4	9.413	157.2	0.040	72.6	0.945	-16.5
200	0.782	-60.7	8.187	138.5	0.070	59.2	0.833	-29.3
400	0.653	-101.1	5.855	113.8	0.101	44.5	0.637	-43.2
600	0.588	-126.5	4.337	98.4	0.114	39.1	0.515	-50.0
800	0.557	-143.7	3.444	87.7	0.122	38.0	0.454	-53.8
1000	0.543	-156.3	2.871	78.5	0.130	38.6	0.426	-57.1
1200	0.536	-166.8	2.446	70.5	0.137	40.3	0.407	-60.3
1400	0.533	-175.5	2.145	63.5	0.146	42.5	0.393	-63.8
1600	0.527	177.0	1.904	57.1	0.155	45.0	0.382	-68.0
1800	0.525	170.3	1.714	51.7	0.168	47.3	0.379	-72.0
2000	0.528	163.8	1.564	45.9	0.183	49.2	0.378	-75.8

# FH202

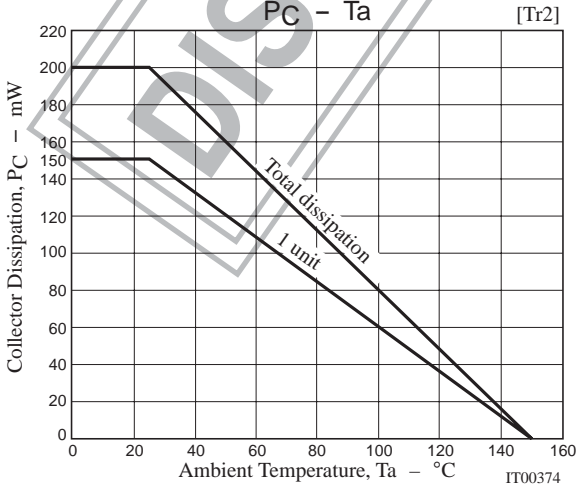
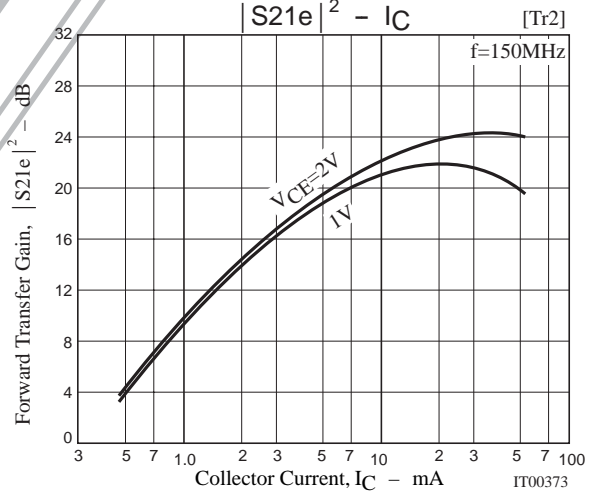
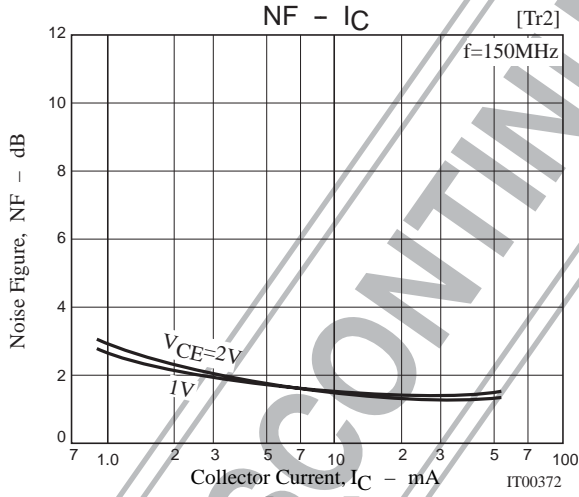
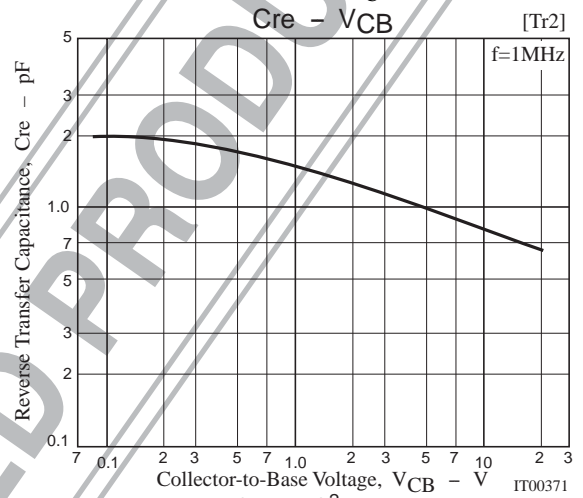
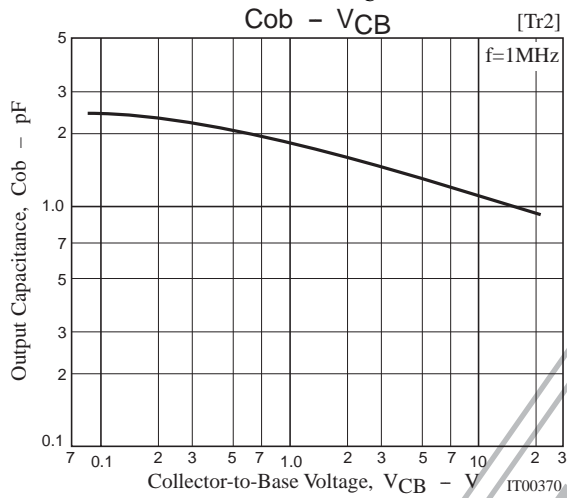
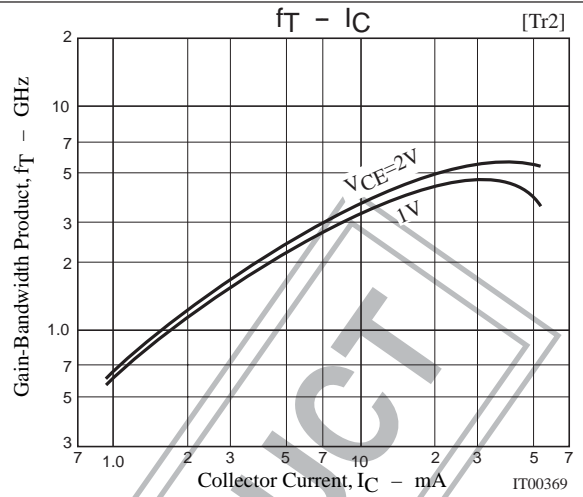
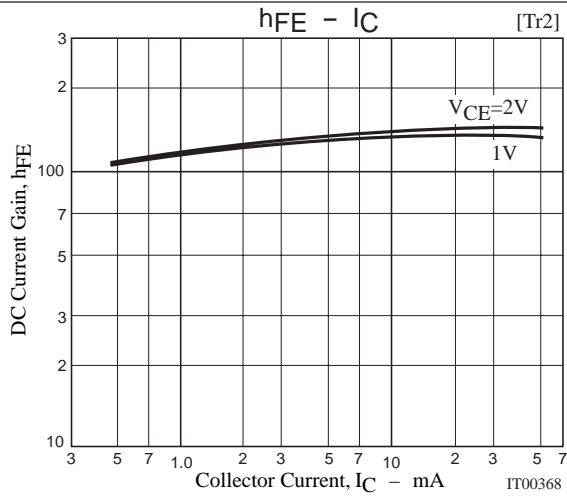

**S parameter [Tr2]**

S11e

f=50MHz to 500MHz(50MHz Step)

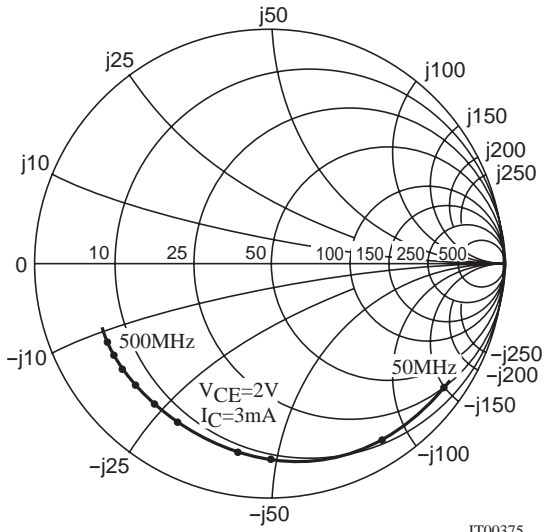

S21e

f=50MHz to 500MHz(50MHz Step)

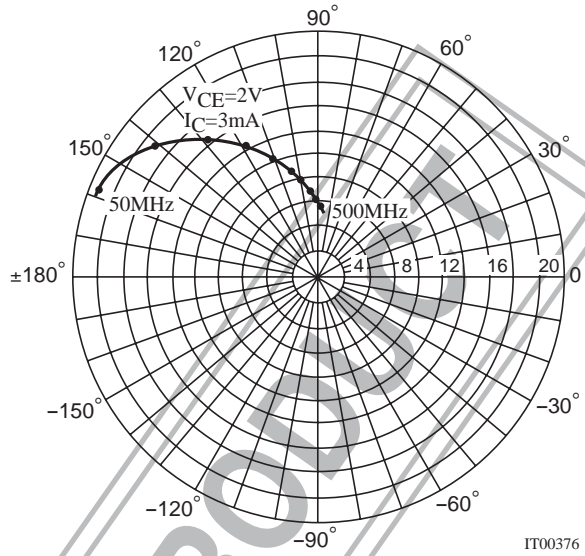

S12e

f=50MHz to 500MHz(50MHz Step)

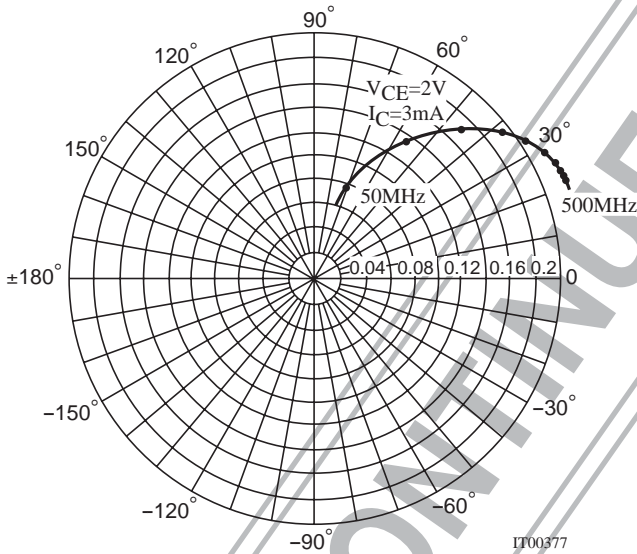

S22e

f=50MHz to 500MHz(50MHz Step)

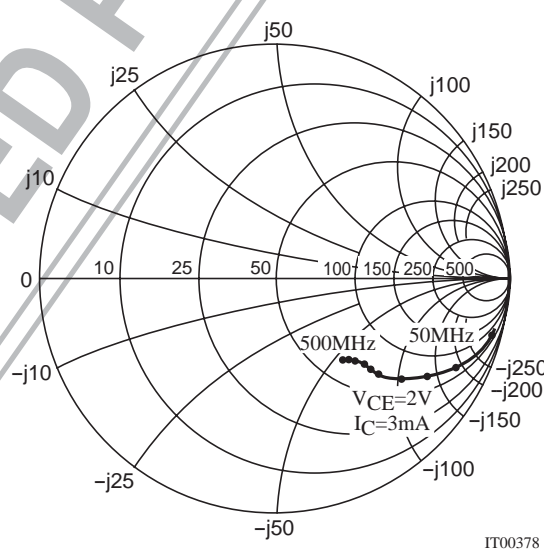

**S Parameters (Common emitter) [Tr2]**

$V_{CE}=2V, I_C=1mA, Z_O=50\Omega$

Freq (MHz)	S <sub>11</sub>	∠ S <sub>11</sub>	S <sub>21</sub>	∠ S <sub>21</sub>	S <sub>12</sub>	∠ S <sub>12</sub>	S <sub>22</sub>	∠ S <sub>22</sub>
50	0.965	-25.6	3.48	163.7	0.040	75.3	0.985	-7.1
100	0.948	-49.3	3.30	149.2	0.075	62.8	0.951	-13.3
150	0.922	-69.5	2.96	136.6	0.101	51.8	0.907	-18.0
200	0.903	-86.0	2.65	126.3	0.119	42.9	0.859	-21.7
250	0.885	-99.4	2.33	117.3	0.131	35.9	0.819	-24.6
300	0.873	-110.4	2.07	110.1	0.139	30.1	0.791	-26.9
350	0.866	-119.4	1.89	103.8	0.145	25.4	0.778	-28.7
400	0.854	-127.4	1.73	97.8	0.147	21.2	0.753	-30.8
450	0.846	-133.9	1.58	92.9	0.148	17.7	0.742	-32.7
500	0.847	-138.9	1.44	88.5	0.148	15.0	0.736	-34.4

## FH202

$V_{CE}=2V, I_C=3mA, Z_0=50\Omega$

Freq (MHz)	S <sub>11</sub>	∠ S <sub>11</sub>	S <sub>21</sub>	∠ S <sub>21</sub>	S <sub>12</sub>	∠ S <sub>12</sub>	S <sub>22</sub>	∠ S <sub>22</sub>
50	0.909	-35.9	9.43	158.4	0.038	71.0	0.949	-14.8
100	0.873	-66.2	8.30	141.0	0.067	56.0	0.849	-26.1
150	0.836	-89.8	7.03	127.6	0.084	44.9	0.744	-33.4
200	0.815	-106.3	5.94	117.9	0.095	37.5	0.658	-38.0
250	0.794	-119.1	5.05	110.4	0.100	32.4	0.590	-41.4
300	0.784	-128.7	4.36	104.3	0.104	28.7	0.550	-43.2
350	0.779	-136.3	3.90	99.4	0.107	26.0	0.518	-44.7
400	0.769	-143.1	3.46	94.8	0.108	23.9	0.493	-45.8
450	0.767	-148.1	3.13	91.3	0.108	22.4	0.474	-47.2
500	0.766	-152.1	2.83	87.8	0.108	21.7	0.463	-48.5

$V_{CE}=2V, I_C=10mA, Z_0=50\Omega$

Freq (MHz)	S <sub>11</sub>	∠ S <sub>11</sub>	S <sub>21</sub>	∠ S <sub>21</sub>	S <sub>12</sub>	∠ S <sub>12</sub>	S <sub>22</sub>	∠ S <sub>22</sub>
50	0.775	-61.9	23.54	145.3	0.033	61.4	0.836	-34.4
100	0.731	-101.2	17.31	124.8	0.048	46.5	0.624	-55.2
150	0.709	-124.3	13.06	112.7	0.056	39.6	0.481	-67.0
200	0.704	-136.7	10.22	105.5	0.060	37.1	0.387	-75.8
250	0.695	-146.3	8.43	100.2	0.064	36.5	0.335	-80.4
300	0.695	-152.6	7.09	96.2	0.066	36.8	0.296	-85.3
350	0.695	-157.6	6.21	92.7	0.070	37.2	0.270	-87.4
400	0.694	-162.0	5.45	89.8	0.072	38.5	0.245	-91.4
450	0.696	-164.9	4.84	87.5	0.075	39.9	0.231	-95.3
500	0.694	-167.7	4.39	85.0	0.078	41.5	0.222	-97.9

$V_{CE}=2V, I_C=30mA, Z_0=50\Omega$

Freq (MHz)	S <sub>11</sub>	∠ S <sub>11</sub>	S <sub>21</sub>	∠ S <sub>21</sub>	S <sub>12</sub>	∠ S <sub>12</sub>	S <sub>22</sub>	∠ S <sub>22</sub>
50	0.647	-98.6	37.50	129.9	0.024	52.4	0.665	-61.6
100	0.657	-134.1	22.96	111.5	0.032	44.8	0.448	-90.7
150	0.663	-149.5	16.09	103.0	0.037	44.8	0.353	-107.8
200	0.665	-157.6	12.33	97.8	0.041	47.3	0.308	-119.8
250	0.664	-163.2	9.95	94.3	0.046	49.5	0.286	-128.1
300	0.667	-167.3	8.35	91.3	0.051	52.2	0.271	-133.9
350	0.669	-170.2	7.23	89.0	0.055	54.0	0.258	-138.9
400	0.672	-173.0	6.33	86.9	0.060	55.9	0.253	-143.4
450	0.670	-174.9	5.64	85.1	0.066	57.2	0.251	-146.5
500	0.671	-176.6	5.08	83.3	0.071	58.3	0.250	-148.4

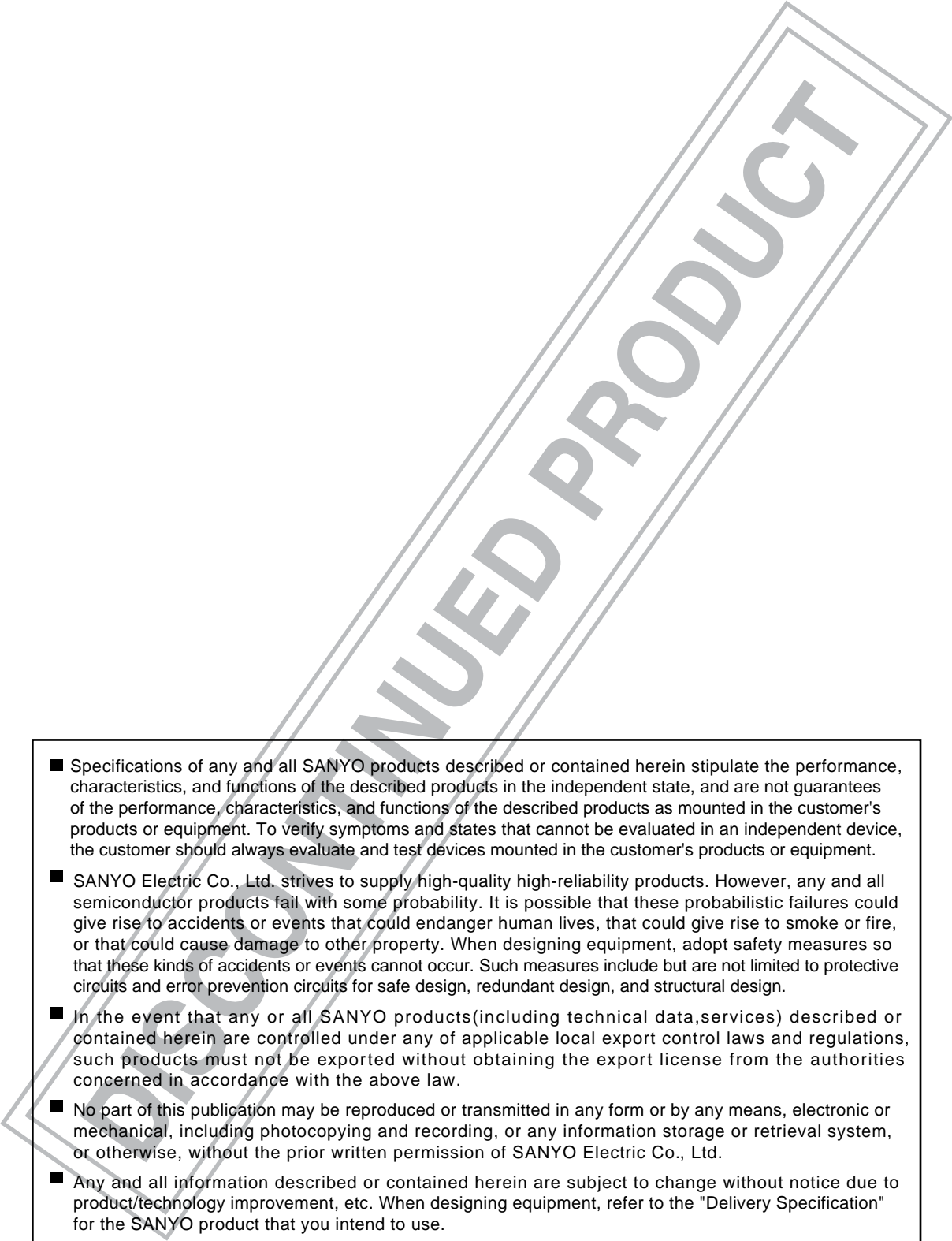
- 
- Specifications of any and all SANYO products described or contained herein stipulate the performance, characteristics, and functions of the described products in the independent state, and are not guarantees of the performance, characteristics, and functions of the described products as mounted in the customer's products or equipment. To verify symptoms and states that cannot be evaluated in an independent device, the customer should always evaluate and test devices mounted in the customer's products or equipment.
  - SANYO Electric Co., Ltd. strives to supply high-quality high-reliability products. However, any and all semiconductor products fail with some probability. It is possible that these probabilistic failures could give rise to accidents or events that could endanger human lives, that could give rise to smoke or fire, or that could cause damage to other property. When designing equipment, adopt safety measures so that these kinds of accidents or events cannot occur. Such measures include but are not limited to protective circuits and error prevention circuits for safe design, redundant design, and structural design.
  - In the event that any or all SANYO products(including technical data, services) described or contained herein are controlled under any of applicable local export control laws and regulations, such products must not be exported without obtaining the export license from the authorities concerned in accordance with the above law.
  - No part of this publication may be reproduced or transmitted in any form or by any means, electronic or mechanical, including photocopying and recording, or any information storage or retrieval system, or otherwise, without the prior written permission of SANYO Electric Co., Ltd.
  - Any and all information described or contained herein are subject to change without notice due to product/technology improvement, etc. When designing equipment, refer to the "Delivery Specification" for the SANYO product that you intend to use.
  - Information (including circuit diagrams and circuit parameters) herein is for example only ; it is not guaranteed for volume production. SANYO believes information herein is accurate and reliable, but no guarantees are made or implied regarding its use or any infringements of intellectual property rights or other rights of third parties.

This catalog provides information as of November, 1999. Specifications and information herein are subject to change without notice.